



HAL
open science

Effect of clay content on the thermal conductivity of unfrozen and frozen sandy soils

Quoc Hung Vu, Jean-Michel Pereira, Anh Minh Tang

► **To cite this version:**

Quoc Hung Vu, Jean-Michel Pereira, Anh Minh Tang. Effect of clay content on the thermal conductivity of unfrozen and frozen sandy soils. *International Journal of Heat and Mass Transfer*, 2023, 206, pp.123923. 10.1016/j.ijheatmasstransfer.2023.123923 . hal-04375028

HAL Id: hal-04375028

<https://enpc.hal.science/hal-04375028>

Submitted on 5 Jan 2024

HAL is a multi-disciplinary open access archive for the deposit and dissemination of scientific research documents, whether they are published or not. The documents may come from teaching and research institutions in France or abroad, or from public or private research centers.

L'archive ouverte pluridisciplinaire **HAL**, est destinée au dépôt et à la diffusion de documents scientifiques de niveau recherche, publiés ou non, émanant des établissements d'enseignement et de recherche français ou étrangers, des laboratoires publics ou privés.

1 Effect of clay content on the thermal conductivity of
2 unfrozen and frozen sandy soils

3 Quoc Hung VU, Jean-Michel PEREIRA, Anh Minh TANG

4 Navier, Ecole des Ponts, Univ Gustave Eiffel, CNRS, Marne-la-Vallée, France

5 Corresponding author:

6 Dr. Anh Minh TANG

7 Director of Research

8 Ecole des Ponts ParisTech

9 6-8 avenue Blaise Pascal

10 77455 Marne-la-Vallée

11 France

12 Email: anh-minh.tang@enpc.fr

13

14

15 **Abstract:** Thermal conductivities of five sandy soils subjected to freezing-thawing and
16 drying-wetting cycles were determined. Specimens were prepared at five different clay
17 contents of 0, 5, 10, 15, 20% prior to compaction at the Proctor maximum dry density. Soil
18 specimens were saturated prior to freezing-thawing and drying-wetting experiments. During a
19 freezing-thawing cycle, soil's thermal conductivity and unfrozen water content were
20 measured at different temperatures ranging from -3 °C to 0 °C. During a drying-wetting cycle,
21 soil's thermal conductivity was measured at different water contents. The experimental results
22 were then compared with predictions by two of the most appropriate existing models, namely
23 De Vries's and Johansen's models, in order to provide insights into the effects of clay content
24 on soil thermal conductivity at (saturated and unsaturated) unfrozen and frozen states.

25 **Keywords:** clay content, thermal conductivity, prediction, unsaturated soils, frozen soils.

26

27

28

29

30

31

32

33

34

35 **1. Introduction**

36 Soil thermal conductivity is one of the key parameters for designing the balance and transfer
37 of heat in many areas of engineering. In cold regions, for instance, soils exist in two states:
38 unfrozen and frozen, depending on many factors such as their composition, pressure and
39 particularly environmental condition (Andersland and Ladanyi, 2004; Cui et al., 2020a;
40 Johansson, 2009; Tian et al., 2016; Zhao and Si, 2019). The state change strongly alters soil
41 thermal conductivity (Cui et al., 2020b; Farouki, 1986; Ji et al., 2021) leading to complexity
42 in the prediction of soil thermal conductivity.

43 In general, thermal conductivity of soils can be measured using two approaches, based either
44 on steady-state or transient-state regimes (He et al., 2021; Zhao et al., 2019). Each approach
45 includes various methods, such as steady-state heat flow meter, steady-state flat plate,
46 transient spherical probe, transient plate source and transient heat pulse (Cui et al., 2020b;
47 Zhao et al., 2019). Within the steady-state approach, thermal conductivity is determined from
48 the proportionality between heat flow and the applied temperature gradient when heat transfer
49 in soil has already reached the steady state. Reversely, within the transient-state approach, a
50 heat input is applied to the tested soil during a certain time and thermal conductivity is
51 determined from the measurement of increasing rate of soil's temperature and the calibration
52 of Fourier's heat transfer law. These methods have been commonly used for measuring
53 thermal conductivity of unfrozen soils. However, their efficiency when applied to frozen soils
54 is questionable. For steady-state methods, a temperature gradient across a soil specimen can
55 result in water redistribution and ice melting. These problems were also found in application
56 of transient-state methods but with smaller impact because small heat input can be considered
57 (He et al., 2021; Yan et al., 2019).

58 Various studies investigated the effects of several parameters on thermal conductivity of
59 unfrozen soils such as temperature (Sepaskhah and Boersma, 1979; Tarnawski and Leong,
60 2000), water content (Abu-Hamdeh, 2003; Nguyen et al., 2017; Smits et al., 2010), dry
61 density (Abu-Hamdeh, 2003; Tang et al., 2008), salinity (Abu-Hamdeh and Reeder, 2000),
62 mineralogy (Bristow, 1998; Côté and Konrad, 2005b) and fines content (Zhang et al., 2017,
63 2015). These effects are directly related not only to thermal properties of each component but
64 also to the arrangement of soil particles.

65 A significant effort in measurement of thermal conductivity of frozen soil has been made,
66 particularly, over recent years (Kersten, 1949; Lu et al., 2018; Penner, 1970; Tian et al., 2017;
67 Zhang et al., 2018). These studies also demonstrated the effects of various parameters on
68 thermal conductivity of frozen soils. The presence of ice (replacing water) changes thermal
69 properties of components (2.2 W/(m.K) for ice and 0.57 W/(m.K) for liquid water) and also in
70 arrangement of grain particles (ice segregation). Consequently, the ratio between ice and
71 unfrozen water strongly affects the heat conduction in soils. In addition to temperature, the
72 amount of unfrozen water or ice in frozen soils also depends considerably on the nature of
73 fine particles and their fraction (Li et al., 2020; Tian et al., 2014; Tice et al., 1976; Zhang et
74 al., 2020).

75 Since several parameters can affect the thermal conductivity of soils, the prediction of the
76 thermal conductivity requires adequate models, able to represent this complexity. For
77 unfrozen soils, many models, developed over the past decades, have shown their efficiency
78 (De Vries, 1963; Farouki, 1986; Johansen, 1977; Kersten, 1949; Mickley, 1951). In particular,
79 by reviewing and evaluating 14 models applied to 62 sands from 20 studies, recently Wang et
80 al. (2020) found that the models of Chen (2008) and Zhang et al. (2017) are the most accurate
81 for thermal conductivity of unfrozen sands over the full range of water content. Unfrozen

82 soils models were also applied for predicting thermal conductivity of frozen soils (Côté and
83 Konrad, 2005a; Johansen, 1977; Tian et al., 2016). By reviewing and evaluating 39 thermal
84 conductivity models for frozen soils, recently He et al. (2021) identified four best models
85 corresponding to four categories consisting of linear/non-linear regression model, physical
86 model, mixing model and normalized thermal conductivity model. However, none of these
87 models could prove a high prediction accuracy. The occurrence of ice at decreasing
88 temperature indeed complicates the role played by soil components (content and distribution)
89 on soil thermal conductivity.

90 Among various parameters, fine particles play an important role in filling the pores between
91 coarse grains and also in increasing surface contact between coarse grains. Depending on the
92 nature of each type of fine particles, their impact on thermal conductivity of soil varies. In the
93 study of Zhang et al. (2015) with pure quartz sand, thermal conductivity of sands was
94 increased to a peak value by increasing the fines content to a critical value. However, the
95 critical fines content depends on the mean grain size ratio of fines to coarse grains, the grain
96 shape and also moisture state. Additionally, in the case of clay-sand mixture, Zhang et al.
97 (2017) showed lower values of critical clay content.

98 Measurements of thermal conductivity were also performed on different types of frozen soils
99 (He et al., 2021; Tian et al., 2016). Kersten (1949) conducted thermal conductivity
100 measurements on 19 soils at various densities, water contents and negative temperatures (-28
101 °C, -18 °C and -4 °C). These 19 studied soils are very diverse in terms of grain size, from clay
102 to gravel. The study showed a higher range and a lower range of thermal conductivity
103 corresponding to sandy soils and clayey soils, respectively. Penner (1970) studied thermal
104 conductivity of two clays at temperatures between 0 °C and -22 °C. Afterwards, Penner et al.
105 (1975) also studied 10 other natural soils of different grain sizes at -5 °C and -15 °C. These

106 two studies showed that, in the high-water content range, thermal conductivity of soils
107 increases with increasing grain size at frozen state. Recently, Tian et al. (2016) showed
108 measurements on five soils consisting in loams, clays and sands at -10 °C. The measurements
109 were combined with data of previous studies to elaborate a simplified de Vries-based model
110 for better prediction. In addition, Lu et al. (2018) specifically studied thermal conductivity of
111 one aeolian sand at -15 °C. In general, these previous studies mainly focused on the effects of
112 dry density or water content on thermal conductivity of frozen soils. Consequently, no
113 experimental study has been conducted on the effects of clay content on frozen soils.
114 However, clay content would modify the microstructure of sandy soils and its hydro-thermal
115 behaviour such as soil freezing characteristic curve (Vu et al., 2022).

116 The present study aims at systematically investigating the effect of clay content on thermal
117 conductivity of unfrozen and frozen sandy soils in two series of experiments corresponding to
118 freezing-thawing and drying-wetting tests. Clean sand was mixed with clay to obtain sandy
119 soils with clay content of 0, 5, 10, 15, and 20% by dry weight prior to compaction at the
120 Proctor maximum dry density followed by a saturation stage. For freezing-thawing process,
121 soil's thermal conductivity and unfrozen water content were measured at different soil's
122 temperatures (ranging from -3 °C to 0 °C) during a freezing-thawing cycle. In parallel,
123 measurement of soil thermal conductivity during a drying-wetting cycle was performed on the
124 same materials. Finally, the performance of two of the most appropriate models (after a recent
125 review) in predicting the obtained experimental results was assessed in order to provide in-
126 depth understanding of the heat conduction process in unfrozen and frozen soils within
127 various clay contents.

128 **2. Materials and experimental method**

129 **2.1. Material**

130 Fontainebleau sand (97-99% quartz) and Speswhite Kaolin clay, whose physical properties
131 determined by Boussaid (2005) are shown in Table 1, were mixed with distilled water to
132 obtain optimum water content determined from Standard Proctor compaction (ASTM, 2021)
133 curves obtained on the same soils. Prior to compaction in a rigid metallic cylindrical cell (150
134 mm in height and 150 mm in diameter) to reach the predetermined density, the wet soils were
135 packed in a plastic bag for at least 24 h for moisture distribution homogenisation. Fig. 1
136 presents the grain size distribution of the investigated soils (the name of each soil corresponds
137 to its clay content: for instance, S10 corresponds to a soil having 10% of clay and 90% of
138 sand in dry mass). Table 2 shows physical properties of specimens in two experiments:
139 freezing-thawing (noted by T1) and drying-wetting (noted by D1). The dry density of the
140 samples shown in Table 2 is close to the maximum dry density of the corresponding sand-clay
141 mixture. Water content at compaction was taken equal to the optimum water content
142 determined by Boussaid (2005). It is worth noting that optimum water contents for
143 intermediate fines content (5% and 15%) have been interpolated from the available data.

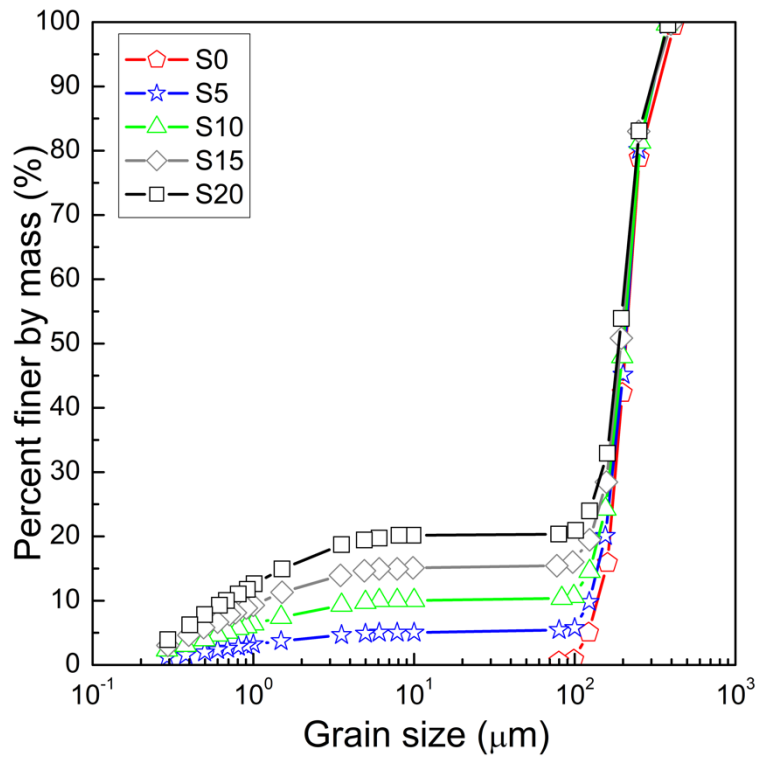

144

145 Fig. 1. Grain size distribution curves.

146 Table 1. Physical properties of Speswhite Kaolin clay and Fontainebleau sand (Boussaid,
147 2005).

Properties	Speswhite Kaolin clay	Fontainebleau sand
Median grain size, D_{50} (mm)	-	0.21
Uniformity coefficient, C_U	-	1.52
Minimum void ratio, e_{min}	-	0.54
Maximum void ratio, e_{max}	-	0.94
Particle density, ρ_s (Mg/m ³)	2.65	2.65
Minimum dry density, $\rho_{d,min}$ (Mg/m ³)	-	1.37
Maximum dry density, $\rho_{d,max}$ (Mg/m ³)	1.45	1.72
Liquid limit, LL (%)	55	-

Plastic limit, PL (%)	30	-
Plasticity index, PI	25	-
Specific surface area (m ² /g)	0.94	-
Particle diameter < 0.002 mm (%)	79	-
Particle diameter > 0.01 mm (%)	0.5	-

148 Table 2. Physical properties of soils in freezing-thawing (T1) and drying-wetting (D1)
149 experiments.

Test No.	Clay content (%)	Water content at compaction (%)	Dry density (Mg/m ³)	Porosity (-)
S20-T1	20	11.2	1.98	0.25
S15-T1	15	9.1	1.99	0.25
S10-T1	10	8.0	1.91	0.28
S5-T1	5	7.0	1.78	0.33
S0-T1	0	5.6	1.67	0.37
S20-D1	20	11.2	1.96	0.26
S15-D1	15	9.1	1.99	0.25
S10-D1	10	8.0	1.93	0.27
S5-D1	5	7.0	1.77	0.33
S0-D1	0	-	1.61	0.39

150 **2.2. Setup and procedure for freezing-thawing experiments**

151 The experimental setup used for freezing-thawing experiments is shown in Fig. 2. The sensors
152 used in the freezing-thawing experiments are shown in Table 3. Soil temperature was

153 measured with a PT100 sensor, soil thermal conductivity was measured with a KD2-Pro (RK-
154 1) probe and soil volumetric water content was measured with a ML2x Thetaprobe sensor.
155 Two empirical equations due to (1) Smith and Tice (1988) and (2) Topp et al. (1980) were
156 used to infer soil volumetric water content from apparent dielectric constant for frozen and
157 unfrozen soil, respectively:

$$(1) \quad \theta_u = -0.1458 + 3.868 \times 10^{-2} \times K_a - 8.502 \times 10^{-4} \times K_a^2 + 9.92 \times 10^{-6} \times K_a^3$$

$$(2) \quad \theta_u = -5.3 \times 10^{-2} + 2.92 \times 10^{-2} \times K_a - 5.5 \times 10^{-4} \times K_a^2 + 4.3 \times 10^{-6} \times K_a^3$$

158 where K_a is the apparent dielectric constant and θ_u is the unfrozen volumetric water content.

159 After compacting the soil specimen in the cylindrical cell at optimum water content to the
160 desired dry density (Table 2) using Standard Proctor compaction procedure, the sensors were
161 inserted into the soil as shown in Fig 2. Afterwards, an expanded polystyrene layer was
162 placed to cover the soil specimen for heat insulation purposes. The soil specimen was then
163 saturated by injecting water from its bottom (for 0.5 to 2 days depending on clay content)
164 until a 10 mm layer of water is visible on the top of the specimen. Afterwards, the cell
165 containing the soil specimen was immersed in a temperature-controlled bath (F38-EH
166 JULABO with ± 0.03 °C accuracy), as shown in Fig. 2, to start the freezing-thawing
167 experiment. The bath temperature was first set at a temperature between 0 °C and -1 °C
168 (slightly higher than the expected temperature of spontaneous ice nucleation). After the
169 temperature stabilised at this initial state, it was then decreased in steps of 0.1 °C to freeze the
170 soil pore water. Once freezing was triggered (most of the liquid water was transformed into
171 ice), the temperature was decreased in steps of 0.2 °C until -2 °C or -3 °C to determine the
172 change in thermal conductivity and liquid water content upon further cooling. Afterwards,
173 during the heating path, the bath temperature was increased in steps of 0.2 °C to 0 °C in order

174 to thaw the frozen soil. During both cooling and heating paths, after the equilibrium was
 175 reached at each step, the thermal conductivity was measured at least three times with a 1-hour
 176 interval between two consecutive measurements to verify the equilibration of soil's
 177 temperature and unfrozen water content. The equilibrium state was considered reached when
 178 changes (during 2 h) in the soil temperature and volumetric unfrozen water content (measured
 179 by the sensors) were negligible ($< 0.05\text{ }^{\circ}\text{C}$ for temperature and $< 1\%$ for water content). Data
 180 from the tensiometer, providing cryo-suction developing when the freezing process is
 181 triggered, were not analysed because they are out of the scope of this paper.

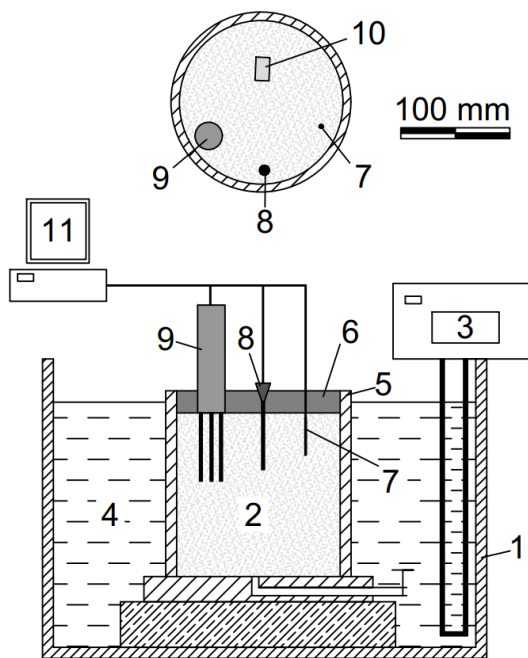

182

183 Fig. 2. Setup for freezing-thawing experiments: (1) Temperature-controlled bath; (2) Soil
 184 specimen; (3) Temperature control system; (4) Heat transfer liquid (30% ethylene glycol +
 185 70% water); (5) Metallic cylindrical cell; (6) Insulating cover; (7) Temperature sensor; (8)
 186 Tensiometer; (9) Soil water content sensor; (10) Thermal conductivity probe; (11) Data

187 logging system. A bar representing a scale of 100 mm is shown to illustrate the setup
 188 dimensions.

189 Table 3. Properties of sensors used in freezing-thawing and drying-wetting experiments.

Measured parameters	Principle	Type	Supplier	Accuracy	Range
Temperature (Freezing-Thawing test)	Resistance temperature detector	PT100	Mersurex	± 0.03 °C	- 200 to 400 °C
Volumetric water content (both tests)	Time domain reflectometry (dielectric permittivity)	ThetaProbe ML2x (4 rods)	AT Delta-T service	$0.01 \text{ m}^3/\text{m}^3$	0.01 to $1 \text{ m}^3/\text{m}^3$
Suction (Freezing-Thawing test)	Tensiometer	T5x	Meter Group	± 0.5 kPa	-160 to 100 kPa
Thermal conductivity (both tests)	Transient line heat source	KD2-Pro (RK-1)	Meter Group	10% of measured value	0.1 to 4 W/(m.K)
Suction (Drying-wetting test)	Tensiometer	T8	Sol Mesures	± 0.5 kPa	-100 to 100 kPa

190

191 2.3. Setup and procedure for drying-wetting experiments

192 The drying-wetting experiments conducted in this study followed a similar methodology to
 193 that described by Nguyen et al (2017). The sensors and experimental setup are shown in Table
 194 3 and Fig. 3. A thermal conductivity sensor KD2-Pro (TR-1) was installed in the centre of the
 195 specimen while two other sensors including water content sensor and tensiometer were
 196 installed close to the cell wall. This configuration minimizes the effect of these two sensors on
 197 the thermal conductivity sensor. The empirical equation (2) due to Topp et al. (1980) was also
 198 used to infer volumetric water content from apparent dielectric constant for soils during
 199 drying-wetting processes. Data from the tensiometer, providing suction developed during the
 200 initial drying, were not analysed because they are out of the scope of this paper.

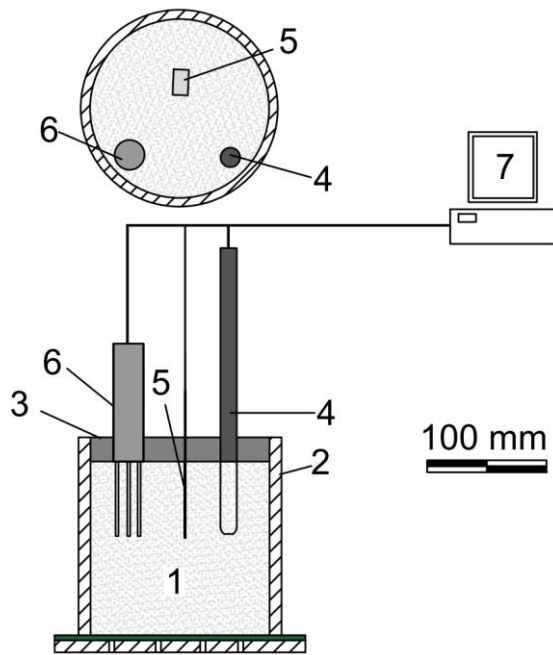

201

202 Fig. 3. Setup for drying-wetting experiments: (1) Soil; (2) Metallic cylindrical cell; (3)
 203 Insulating cover; (4) Tensiometer; (5) Thermal conductivity probe; (6) Soil water content
 204 sensor; (7) Data logging system. A bar representing a scale of 100 mm is shown to illustrate
 205 the setup dimensions.

206 After compaction and saturation, the soil specimen was first subjected to a drying path in
 207 steps. For this purpose, two holes (50 mm in diameter) were created on the top cover allowing
 208 soil water to evaporate. For each drying step, the two holes were opened to allow evaporation
 209 from the top surface. A fan was put next to the specimen to increase the evaporation rate.
 210 After a certain duration, the two holes were covered by two lids to avoid moisture exchange
 211 with the atmosphere. The equilibrium moisture was reached after several hours. Moisture
 212 equilibrium was tracked by volumetric water content and suction sensors. When water
 213 evaporation took place, the measured suction increased quickly and the measured water
 214 content decreased quickly. During the equilibrium phase, suction decreased and water content
 215 increased slowly to reach equilibrium. Similar phenomena have been observed in Nguyen et

216 al. (2017). Thermal conductivity measurements were performed at equilibrium prior to the
217 subsequent drying step.

218 After the drying path, the soil specimen was also subjected to a wetting path in steps. For each
219 step, a small quantity of water was added through the two holes on the top cover, which were
220 then closed for several hours to ensure that water was redistributed homogeneously within the
221 specimen.

222 The homogeneity of water distribution (equilibrium state), during both drying and wetting
223 paths, was assumed to be reached when changes in soil suction and soil volumetric water
224 content during a 1-hour period were negligible (< 1 kPa for suction and $< 1\%$ for water
225 content). At the end of each step, soil thermal conductivity was measured three times with a
226 1-hour interval between two consecutive measurements.

227 **3. Experimental results**

228 **3.1. Thermal conductivity of frozen soil**

229 As an example of a freezing-thawing test, the results of test S10-T1 are shown in Fig. 4,
230 where soil temperature (T), volumetric unfrozen water content (θ_w) and thermal conductivity
231 (λ) are plotted versus elapsed time. Initially, T was imposed at -1.2 °C without inducing
232 freezing (formation of ice). A cooling path was first applied by decreasing T in steps of 0.1
233 °C. During the period where T remained higher than -1.6 °C, T was controlled through the
234 bath's temperature, θ_w and λ remained constant. At 77 h (when T was imposed at -1.6 °C),
235 freezing process occurred showing an abrupt increase of T to -0.1 °C prior to a progressive
236 decrease to reach the imposed temperature (-1.6 °C) again. At this time, θ_w decreased to 3%
237 (because of the formation of ice) while λ increased from 4 W/(m.K) to 5 W/(m.K). After this

238 first formation of ice, T was further decreased in steps of $-0.2\text{ }^{\circ}\text{C}$ from $-1.7\text{ }^{\circ}\text{C}$ to $-2.9\text{ }^{\circ}\text{C}$. λ
 239 increased while θ_w slightly decreased during this further cooling path. When T reached -2.9
 240 $^{\circ}\text{C}$, a heating path was imposed in steps of $0.2\text{ }^{\circ}\text{C}$. During this path, θ_w increased
 241 progressively while λ decreased. It is noted that the two particularly high values of λ at 400 h
 242 and 560 h were observed but they were not considered as reliable values due to the effect of
 243 latent heat on measurement. Actually, during the measurement by the linear heat source
 244 method, a constant heat power was supplied and slightly heated the probe. Thermal
 245 conductivity was estimated by the rate of probe's temperature increase with the logarithm of
 246 time. When measurements were performed close to the freezing temperature, this heating
 247 would induce water thawing in the vicinity of the probe. This thawing required heat (latent
 248 heat) and reduced the probe's temperature (inducing an overestimation of thermal
 249 conductivity). These measurements are thus not presented in the following figures.

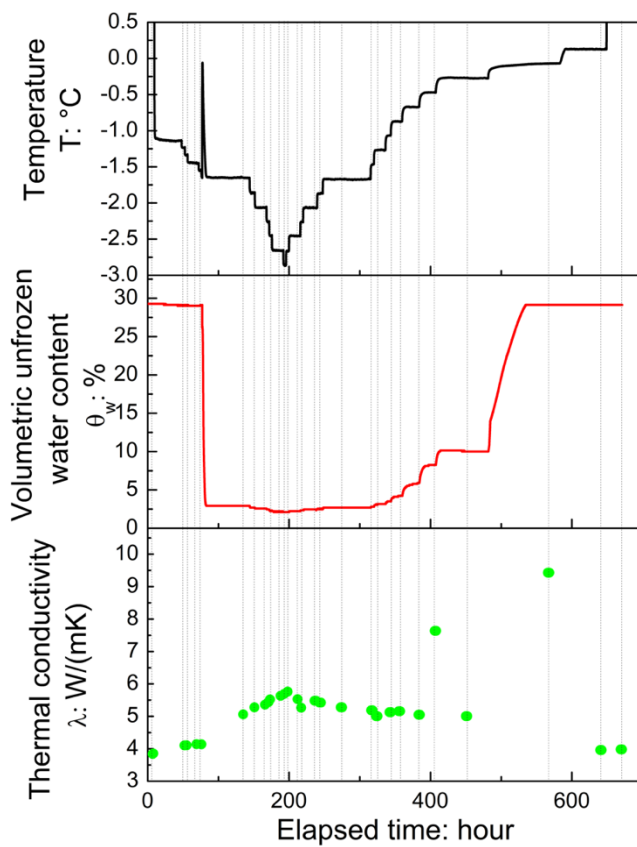

250

251 Fig. 4. Time evolution of temperature, unfrozen volumetric water content and thermal
252 conductivity during test S10-T1.

253 Fig. 5 shows, for test S10-T1, the relationships between T , λ , and θ_w obtained at the end of
254 each step included in a freezing path and a subsequent thawing path (the considered
255 equilibrium state corresponds to the vertical dotted lines shown in Fig. 4). During the cooling
256 path (dark line), as shown in Fig. 5a, freezing occurred when T reached $-1.6\text{ }^\circ\text{C}$, inducing a
257 sudden decrease of θ_w from 28% to 3%. When T continued to decrease to $-2.9\text{ }^\circ\text{C}$, θ_w
258 decreased slightly to 2%. During the heating path (red line), thawing occurred progressively
259 inducing an increase of θ_w . The relationship between θ_w and T is similar between the cooling
260 and the heating paths, except for the period before the occurrence of freezing. Similar
261 conclusions can be observed on the relationship between λ and T (Fig. 5b). However, a
262 unique relationship can be observed between λ and θ_w (Fig. 5c).

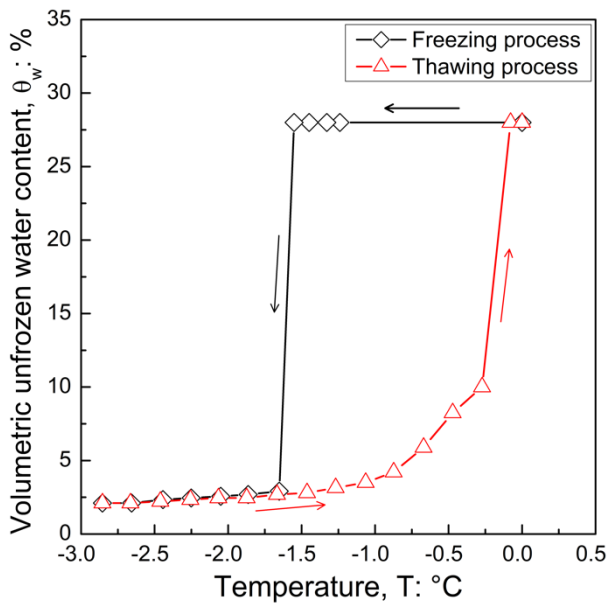

(a)

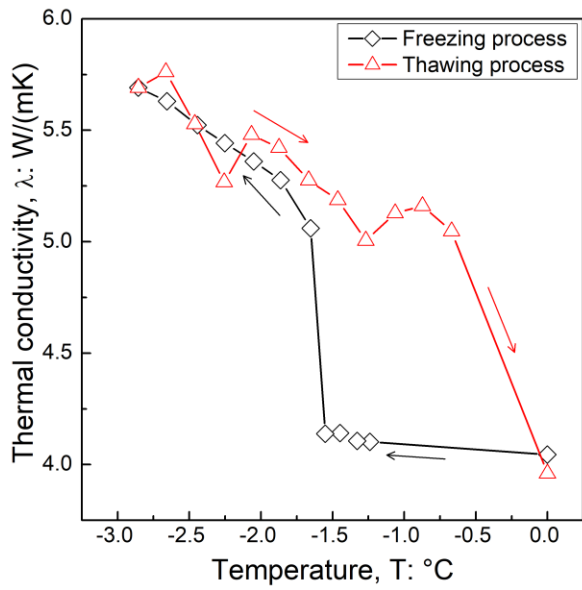

(b)

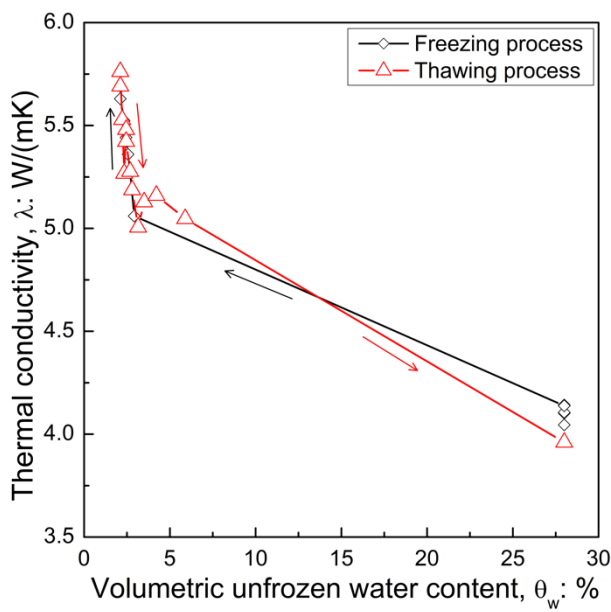

(c)

263 Fig. 5. Relationships between (a) volumetric unfrozen water content and temperature, (b)
 264 thermal conductivity and temperature, (c) thermal conductivity and volumetric unfrozen water
 265 content of test S10-T1.

266 Detailed analyses of the relationship between volumetric unfrozen water content and
 267 temperature (soil freezing characteristic curve) obtained for all soils were presented in Vu et
 268 al. (2022). In the present work, results on thermal conductivity are further analysed.

269 Fig. 6 presents the results of all the freezing-thawing experiments where λ is plotted versus T .
 270 It can be observed that all these results show similar trends. During the initial cooling, λ did
 271 not change when T decreased. λ increased abruptly when freezing occurred. Afterwards, the
 272 relationship between these two quantities were similar on the freezing and thawing paths.
 273 Generally, λ was higher at a lower T .

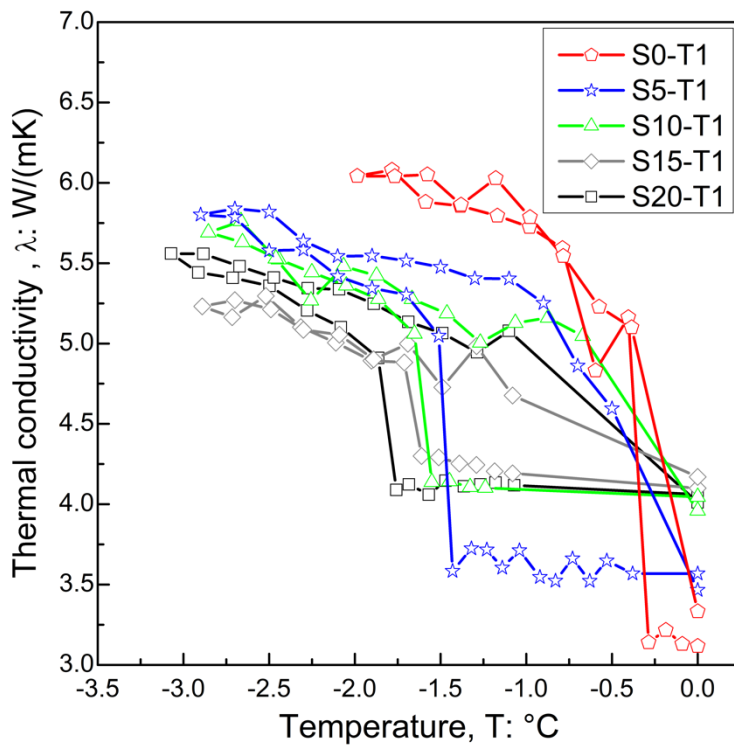

274
 275 Fig. 6. Thermal conductivity versus temperature for all freezing-thawing experiments.

276 Fig. 7 presents the results of all specimens at frozen state where λ is plotted versus θ_w and T .
 277 It can be observed that all these results show a reversible behaviour of λ at frozen state,
 278 particularly with θ_w . λ increased significantly with decreasing θ_w in the range of low values

279 of unfrozen water content. In addition, to provide the same thermal conductivity, volumetric
280 unfrozen water content has to be higher for a higher clay content. Otherwise, as shown in Fig.
281 7b, at the same temperature in frozen state, adding fines (from 0% to 15%) decreases λ
282 significantly.

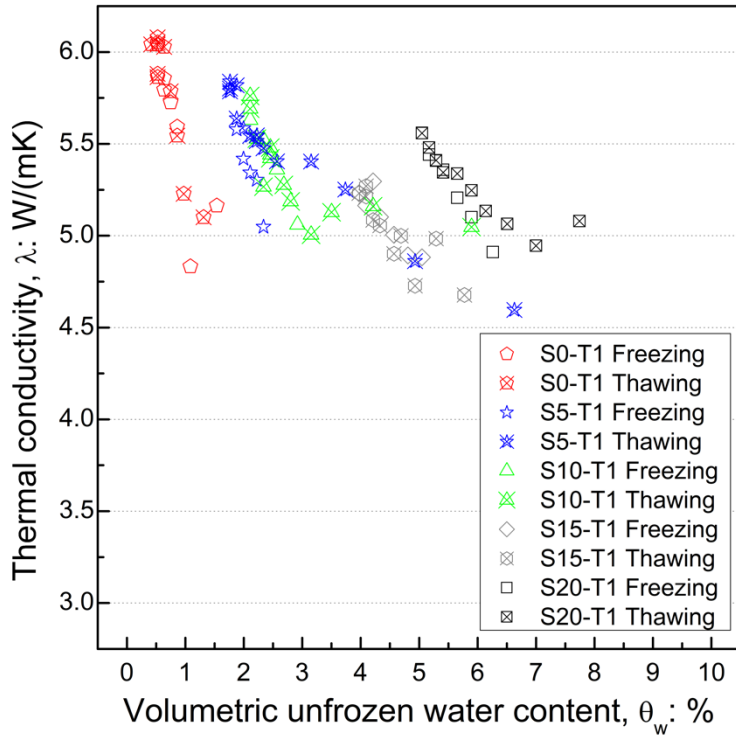

283

284 (a)

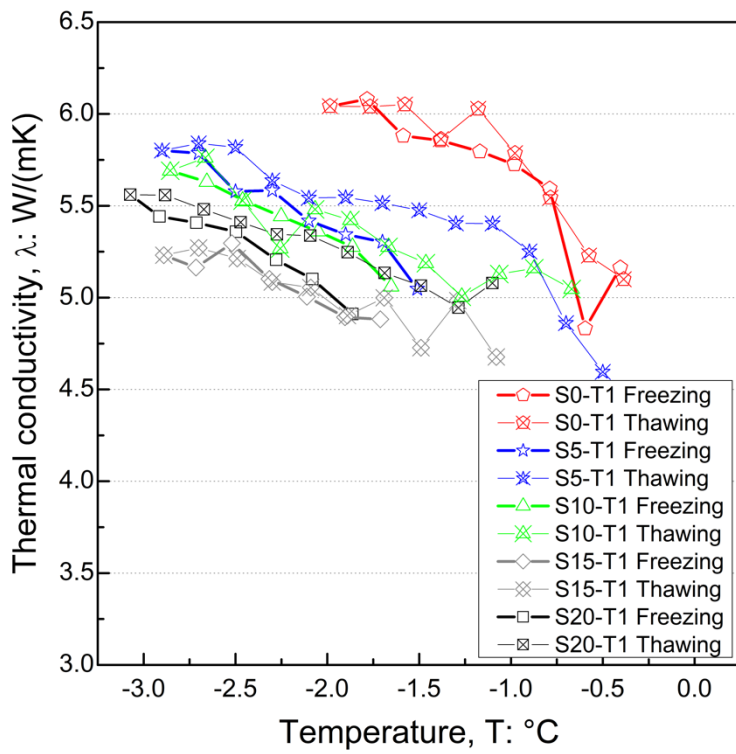

285

286 (b)

287 Fig. 7. Thermal conductivity versus (a) volumetric unfrozen water content and (b)
288 temperature for all freezing-thawing experiments.

289 Fig. 8 presents thermal conductivity versus water degree of saturation (S_w) only for soils at
290 frozen state. Generally, λ was higher at a lower value of S_w . Beside the experimental results,
291 results obtained by models' prediction are also plotted for comparison in this figure (see
292 section 4).

293

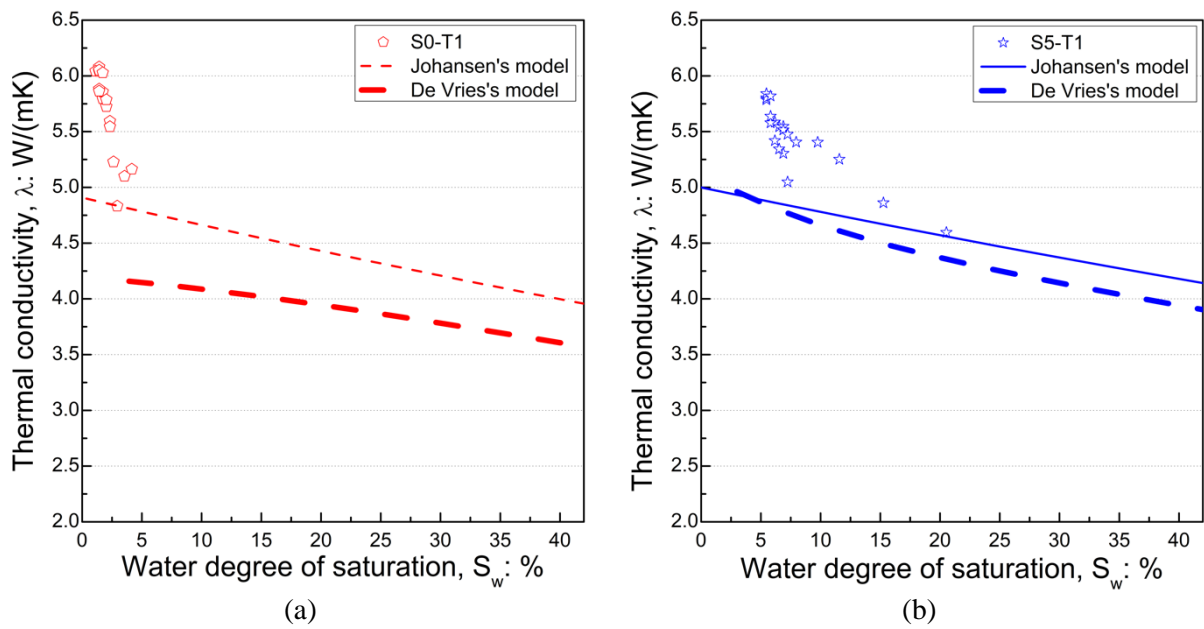

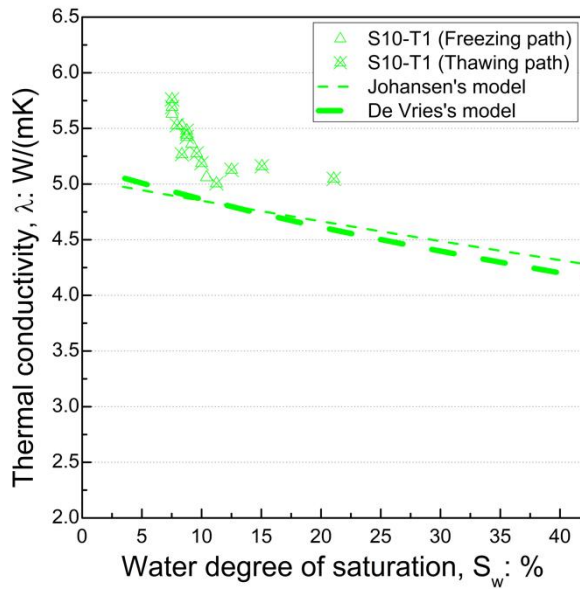

(c)

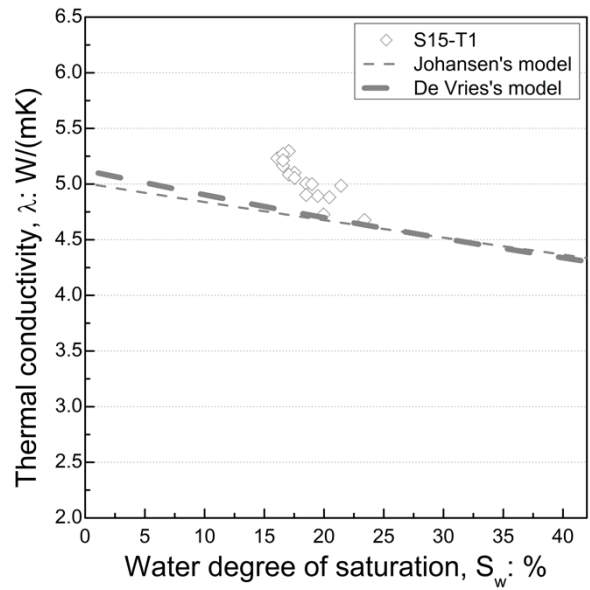

(d)

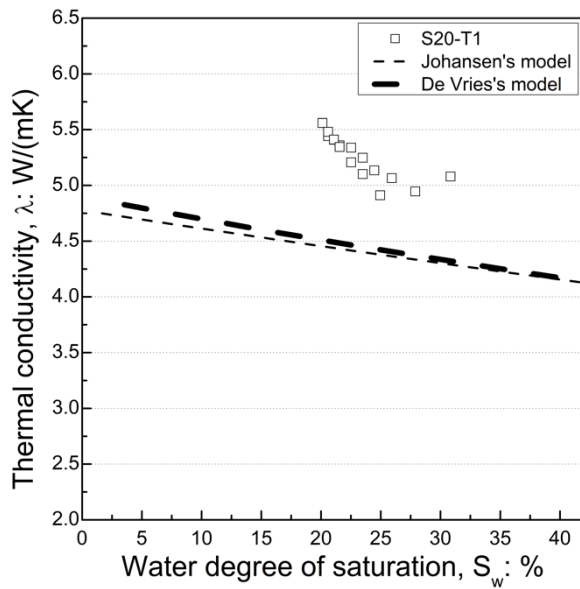

(e)

294 Fig. 8. Experimental results and models' prediction for thermal conductivity versus water
 295 degree of saturation for frozen soils: (a) S0-T1; (b) S05-T1; (c) S10-T1; (d) S15-T1; (e) S20-
 296 T1.

297 **3.2. Thermal conductivity of unfrozen soil**

298 Fig. 9 shows the evolution of θ_w and λ versus time for test S10-D1. From the beginning to
299 650 h, the specimen was subjected to various drying steps prior to be subjected to further
300 wetting steps until 1000 h. From the initial state with $\theta_w = 25.3\%$, water evaporation takes
301 place when removing the two lids and θ_w decreased slowly. After several hours, covering the
302 holes with the lids again prevented water evaporation. θ_w continued to decrease with lower
303 rate prior to stabilizing in further hours at 21.6% and measurement of λ was then conducted.
304 Such drying step was repeated 8 times until $\theta_w = 14.2\%$ prior to wetting path. From 650 h,
305 first addition of water in two holes induced a slow increase of θ_w , which stabilized at 15%.
306 The measurement of λ was then also performed prior to the second water addition. In the
307 subsequent wetting steps, adding water induced an abrupt and immediate increase of θ_w ,
308 which decreased afterward with slow rate prior to stabilizing. The wetting path was stopped at
309 $\theta_w = 22.3\%$.

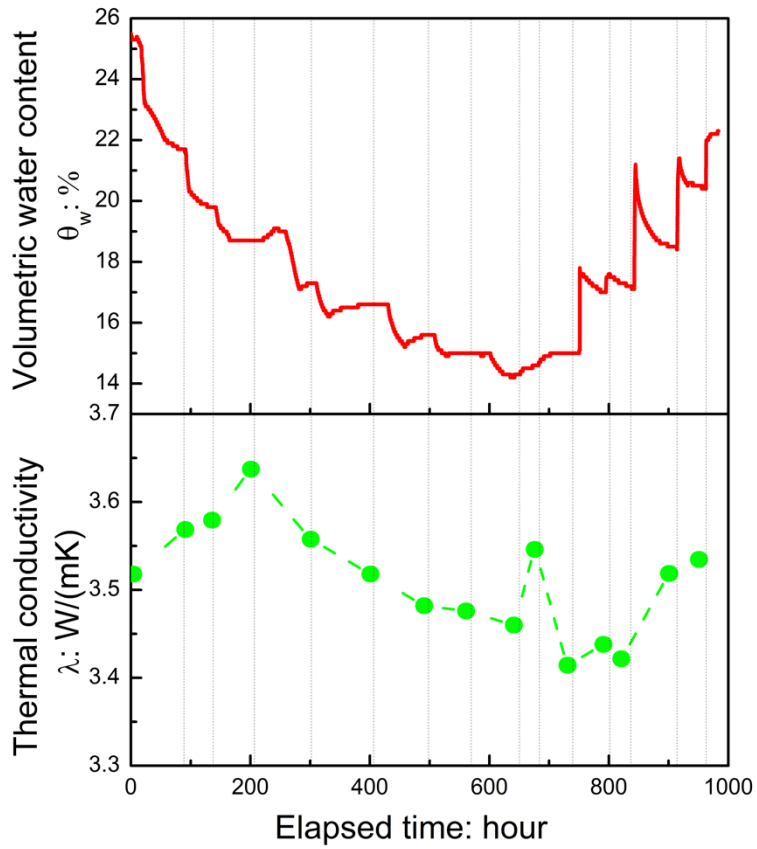

310

311 Fig. 9. Volumetric water content and thermal conductivity of unfrozen soils in wetting-drying
 312 process of S10-D1.

313 Fig. 10 shows the relationship between λ and water degree of saturation (S_w) for all drying-
 314 wetting experiments. S_w was calculated from θ_w and soil porosity (n). In this figure, S_w was
 315 plotted instead of θ_w in order to facilitate the comparison with data taken from existing
 316 studies. Measurements of thermal conductivity of pure sand in drying-wetting experiment
 317 (S0-D1) were not conducted and available data found from the literature (Vieira et al., 2019)
 318 were used. The results show that adding fines (from 0% to 15%) increased significantly λ

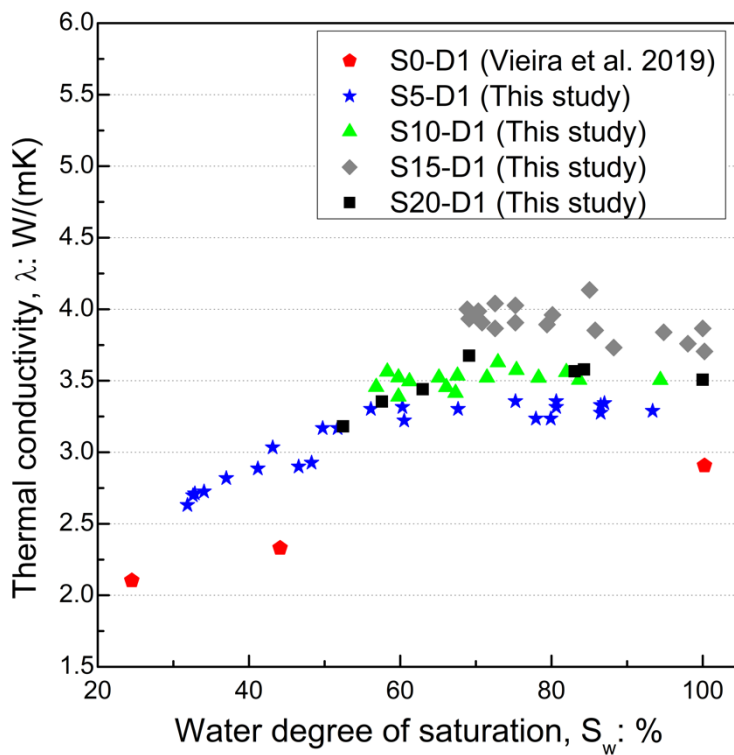

319

320 Fig. 10. Thermal conductivity versus water degree of saturation for all drying-wetting
 321 experiments.

322 Fig. 11 shows predictions of models. Zhang et al. (2017) presented data obtained on sand-
 323 kaolin mixtures (having similar clay content) compacted at various porosities and degrees of
 324 saturation. The sand used in the work of Zhang et al. (2017) was Ottawa-type silica sands
 325 (pure sand with more than 99% quartz content). These results are also plotted in Fig. 11.

326 Results obtained by models' prediction are described in Section 4. All the results showed a
 327 strong correlation between λ and S_w for a given porosity (a higher λ was generally obtained at
 328 a higher S_w). It is noted that, above $S_w = 60\%$, thermal conductivity remained constant for all
 329 soils. Results on pure sand (Fig. 11a) showed that the relationship between λ and S_w was
 330 independent of the porosity. For sand-clay mixture, at a given S_w , a higher λ was generally
 331 obtained at a lower porosity (Fig. 11b,c,e). Zhang et al. (2017) did not perform tests on
 332 mixture with clay content of 15% (Fig. 11d). The results obtained in the present work
 333 correspond to the range of high degree of saturation (from 50 % to 100%), this range was not

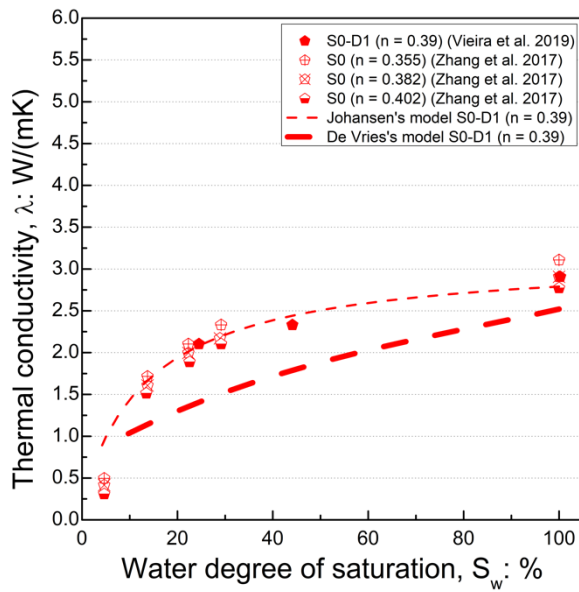

(a)

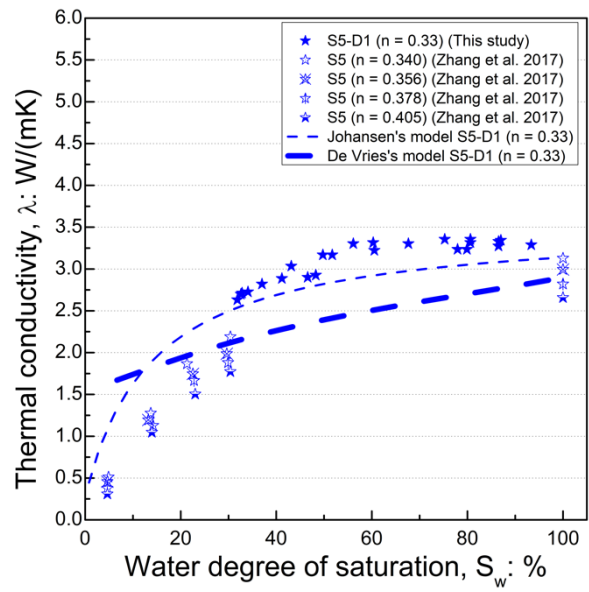

(b)

334 investigated in the work of Zhang et al. (2017).

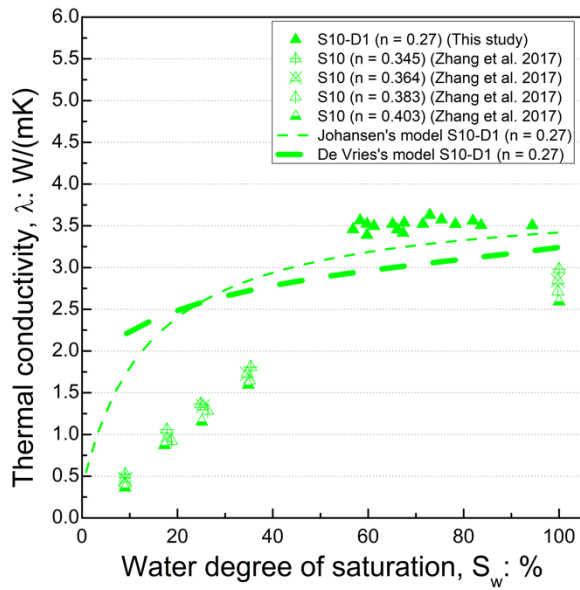

(c)

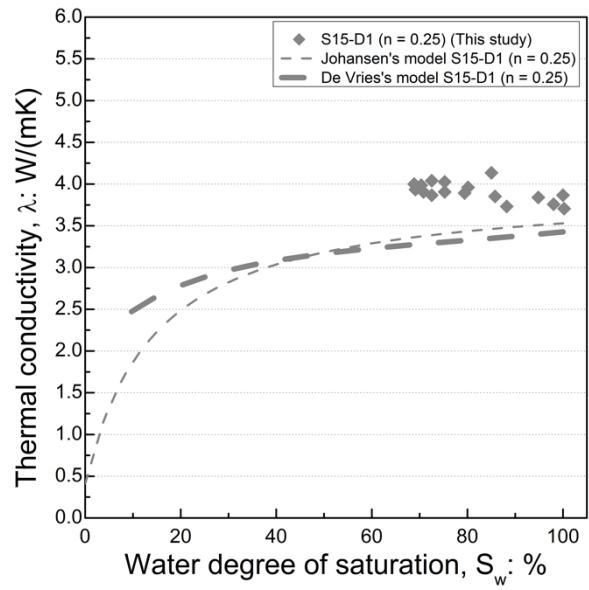

(d)

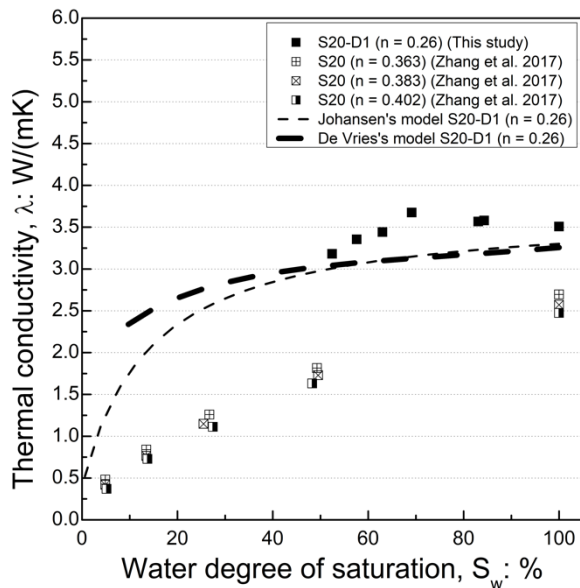

(e)

335 Fig. 11. Experimental results (obtained in this study and that of Zhang et al. 2017) and models
 336 prediction for thermal conductivity versus water degree of saturation for unfrozen soils: (a)
 337 S0; (b) S5; (c) S10; (d) S15; (e) S20.

338 **4. Prediction of soil thermal conductivity**

339 Based on the recent review of He et al. (2021) on 39 models to predict thermal conductivity of
340 frozen soils, two appropriate models were chosen in this study, namely De Vries's model (De
341 Vries, 1963) and Johansen's model (Johansen, 1977). Actually, these models can be used for
342 both frozen and unfrozen soils. They can consider the change in unfrozen water content in
343 frozen soil with temperature change and the effect of clay content.

344 For the prediction of thermal conductivity of unfrozen and frozen soil in this study, frozen soil
345 was considered as a medium made of four components: unfrozen water, ice, sand and clay,
346 whose volumes are noted as V_w, V_i, V_s, V_c , respectively while unfrozen soil was also considered
347 as a medium made of four components: water, air, sand and clay, whose volumes are noted as
348 V_w, V_a, V_s, V_c , respectively.. The thermal conductivity of water (λ_w) was taken equal to 0.57
349 W/(m.K) while those of ice (λ_i) and air were taken equal to 2.28 W/(m.K) and 0.025
350 W/(m.K), respectively (Farouki, 1986). For the soil particles, the thermal conductivity of
351 kaolin (λ_c) was taken equal to 2.44 W/(m.K) while that of sand (λ_s) equal to 7.70 W/(m.K)
352 (Tarnawski et al., 2015).

353 **4.1. De Vries's model**

354 The De Vries's model was extended for predicting thermal conductivity of frozen soil
355 (Farouki, 1986; Tian et al., 2016). In the review of He et al. (2021), the simplified De Vries-
356 based model with the considered shape factors was proved as the best among physical models
357 (Tian et al., 2016). In this study, for better fitting experimental data, De Vries's model is
358 applied considering that ice and sand particles are components immersed in the continuous
359 medium (fluid) that contains water and clay particles, as shown in Fig. 12. The thermal
360 conductivity of frozen soil is then expressed as:

$$(3) \quad \lambda = \frac{\left(\frac{V_f}{V}\right)\lambda_f + F_i \left(\frac{V_i}{V}\right)\lambda_i + F_s \left(\frac{V_s}{V}\right)\lambda_s}{\frac{V_f}{V} + F_i \left(\frac{V_i}{V}\right) + F_s \left(\frac{V_s}{V}\right)}$$

361 Where F_s, F_i are the weighting factors depending on the shape and the orientation of sand and
 362 ice particles, respectively. Considering ellipsoidal shape for ice and sand particles, the
 363 weighting factor F_n (with $n = \{s, i\}$) is given from shape factor g_a as follows:

$$(4) \quad F_n = \frac{1}{3} \left\{ \frac{2}{1 + \left(\frac{\lambda_n}{\lambda_f} - 1\right) g_a} + \frac{1}{1 + \left(\frac{\lambda_n}{\lambda_f} - 1\right) (1 - 2g_a)} \right\}$$

364 with $g_{a(sand)} = 0.182$ (Tarnawski and Wagner, 1992) and

$$(5) \quad g_{a(ice)} = 0.333 \left(1 - \frac{\theta_{ice}}{n}\right)$$

365 where, n is the porosity of soil, θ_{ice} is the ice content. The fluid mixture (water and clay
 366 particles) properties are given by:

$$(6) \quad \lambda_f = \lambda_w^{\frac{V_w}{V_w+V_c}} \lambda_c^{\frac{V_c}{V_w+V_c}}$$

$$(7) \quad V_f = V_w + V_c$$

367 and the total volume is:

$$(8) \quad V = V_w + V_i + V_s + V_c$$

368 The De Vries's model was also used to predict thermal conductivity of unfrozen soils in
 369 drying-wetting process. In this case, unfrozen soil is composed of sand, air immersed in liquid
 370 (mixture of clay and water). The thermal conductivity of unfrozen soil is expressed as:

$$(9) \quad \lambda = \frac{\left(\frac{V_f}{V}\right)\lambda_f + F_a\left(\frac{V_a}{V}\right)\lambda_a + F_s\left(\frac{V_s}{V}\right)\lambda_s}{\frac{V_f}{V} + F_a\left(\frac{V_a}{V}\right) + F_s\left(\frac{V_s}{V}\right)}$$

371 The weighting factors F_s , F_a are similar to the previous expression with the shape factor
 372 below:

$$(10) \quad g_{a(air)} = 0.333 - \frac{\theta_{air}}{n}(0.333 - 0.035)$$

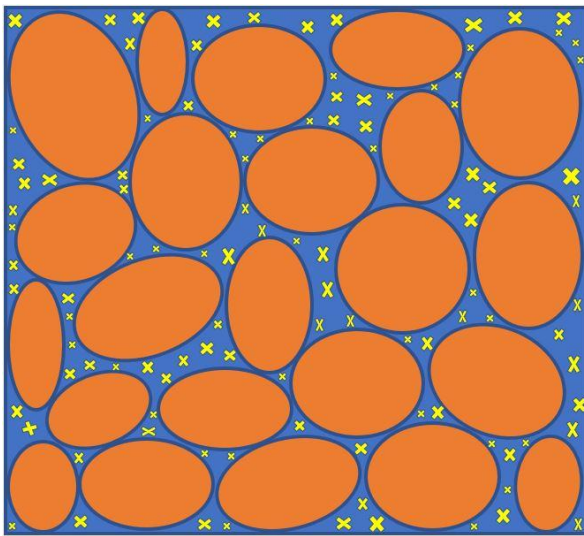

(a)

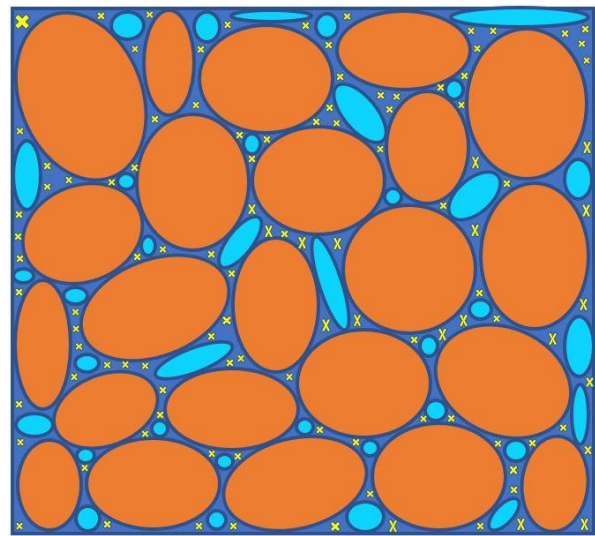

(b)

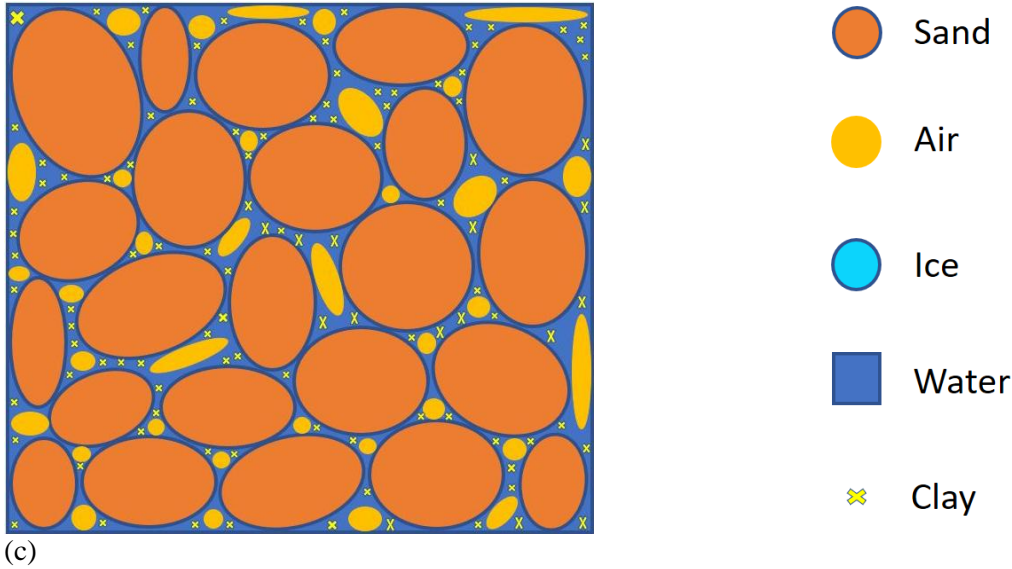

373 Fig. 12. Schematic view of soil media in (a) unfrozen saturated state, (b) frozen saturated state
 374 and (c) unfrozen unsaturated state.

375 The comparison (Fig. 8) showed that the De Vries's model underestimated measured values
 376 of λ of all frozen soils. The model also showed a higher λ at a lower S_w but could not capture
 377 the strong effect of S_w when this later is small. For unfrozen soils (Fig. 11), the De Vries'
 378 model also showed a higher λ at a higher S_w but could not capture accurately the relationship
 379 between these two parameters for the whole range of S_w (varying from 0 to 100%).

380 4.2. Johansen's model

381 Geometric mean was proposed to calculate the thermal conductivity (λ) of saturated frozen
 382 soil by Johansen (Johansen, 1977):

$$(11) \quad \lambda = \lambda_w^{f_w} \lambda_i^{f_i} \lambda_c^{f_c} \lambda_s^{f_s}$$

383 where f_w, f_i, f_c, f_s are volume fraction of water, ice, clay and sand, respectively.

384 In this study, for unfrozen soils subjected to drying-wetting process, the thermal conductivity
385 introduced by Johansen was expressed as:

$$(12) \quad \lambda = (\lambda_{sat} - \lambda_{dry})K_e + \lambda_{dry}$$

386 where λ_{sat} , λ_{dry} are respectively the thermal conductivity in saturated and dry states at the
387 same dry density, K_e is a function representing the influence of water degree of saturation S_w
388 on the thermal conductivity. According to Côté and Konrad (2005a), K_e is proposed as
389 follows:

$$(13) \quad K_e = \frac{\kappa S_w}{1 + (\kappa - 1)S_w}$$

390 where κ is an empirical parameter accounting for the soil type effect. Zhang et al. (2017)
391 proposed an equation to illustrate the relationship between κ and quartz (sand) content. In this
392 study, $\kappa = 8$ was chosen because it provided the best prediction.

$$393 \quad (14) \quad \lambda_{dry} = \frac{0.135\rho_d + 64.7}{\rho_s - 0.947\rho_d} \text{ W/(m. K)}$$

$$(15) \quad \lambda_{sat} = \lambda_w^{f_w} \lambda_c^{f_c} \lambda_s^{f_s} \text{ W/(m. K)}$$

394 where the dry unit weight, ρ_d , and the unit weight of the solids, ρ_s , are expressed in kg/m^3 .

395 For frozen soils, compared to De Vries's model, Johansen's model predicted higher values for
396 soils with low clay content (S0-T1, S5-T1, S10-T1) but the improvement was not significant
397 (Fig. 8). For soils with high clay contents, the two models provided similar results.

398 For unfrozen soils, the modified Johansen's model proposed by Zhang et al. (2017) gave a
399 better prediction compared to the De Vries's model (Fig. 11). It gave better prediction for

400 soils with low clay contents (S0-D1, S5-D1, S10-D1). However, for soils with high clay
401 contents, the improvement compared to De Vries's model was not significant.

402 **5. Discussion**

403 The measurement of unfrozen water content in the present study was converted from the
404 measurement of the apparent dielectric constant. The latter was calculated from the dielectric
405 constant of each component in soils, particularly water and ice, which are influenced by
406 temperature variation (Haynes, 2016; Wraith and Or, 1999). Several existing models can
407 estimate moisture content from unfrozen soil apparent dielectric constant (Birchak et al.,
408 1974; He and Dyck, 2013; Nagare et al., 2011; Roth et al., 1990; Schafer and Beier, 2020;
409 Smith and Tice, 1988; Stähli and Stadler, 1997; Topp et al., 1980; Watanabe and Wake,
410 2009). The most used is Topp's empirical model (Topp et al., 1980) but it is not compatible
411 with frozen soils (Smith and Tice, 1988; Spaans and Baker, 1995; Zhou et al., 2014).
412 Otherwise, Smith and Tice (1988) proposed a model based on the comparison of unfrozen
413 water content measured from NMR and TDR methods for 25 soils covering a wide range of
414 specific surface areas. For this reason, in the present work, the model of Smith and Tice
415 (1988), which provides an accuracy of $\pm 3\%$ compared to measurements from NMR method,
416 considered as the reference, was used for frozen soils.

417 During the freezing process, the volume of specimen would increase, thus modifying the
418 contact between soil and the probes. In the present work, the potential lateral expansion of the
419 specimen is prevented by the rigid metallic cell. The soil/probe contact was thus supposed to
420 be not influenced by the freezing process.

421 The obtained results show that the thermal conductivity of soil (λ) at frozen state is higher
422 than that at unfrozen state. Even if this trend was observed in various existing studies, most of
423 the existing works provide data corresponding to one or few values of negative temperature.
424 Few works provided an almost continuous relationship between λ and soil temperature. In the
425 present work, during the thawing path, the rate of decrease of λ with temperature change for
426 temperature in the range of $-3\text{ }^{\circ}\text{C}$ to $-1\text{ }^{\circ}\text{C}$ was lower than in the range of $-1\text{ }^{\circ}\text{C}$ to $0\text{ }^{\circ}\text{C}$ (Fig.
427 6). Similar trend was observed by Overduin et al. (2006) and Zhang et al. (2018). Such a
428 difference induced by the phase change of water can be explained by the conductivity of ice
429 (λ_i) being approximately four times higher than that of liquid water (λ_w). These values
430 depend significantly on temperature and pressure. However, λ_i (Bonales et al., 2017; Slack,
431 1980) and λ_w (Lawson et al., 1959) can be considered as constants in the relatively small
432 temperature range investigated in the present study. It is believed that the increase of λ after
433 freezing occurrence relates mainly to the small amount of water transforming into ice because
434 there was almost no hysteresis observed in the relationship between λ and θ_w in this range. As
435 illustrated in Fig. 12, ice is mainly formed from water in the centre of the pores. In the case
436 where ice could not contain clay, the decrease of unfrozen water content caused the increase
437 of clay concentration in unfrozen water. It is noted that this latter plays a role as a contact
438 between sand grains. The phenomenon of increasing clay concentration in water contributes
439 considerably to the efficiency of heat conduction because it not only increases the thermal
440 conductivity of the fluid (Kim et al., 2011), but also strengthens heat transfer between sand
441 grains (Johansen, 1977).

442 The two chosen models were not able to predict well the thermal conductivity of frozen sandy
443 soils in this study. For De Vries's model, considering the continuous medium (fluid) as a
444 mixture of water and clay particles with ellipsoidal shape for ice and sand particles could

445 contribute to the low accuracy of the model. It is noted that in this model, considering λ_i and
446 λ_s as constants, the application of geometric mean for λ_f is consistent with the measurements
447 on saturated kaolinite in the study of Kim et al. (2011). For Johansen's model, geometric
448 mean formula could only consider the thermal conductivity of each component and their
449 fraction. So that small change in f_i and f_w could not induce significant changes in the thermal
450 conductivity of frozen soils. In addition, both models could not properly capture the
451 components arrangement that affects how heat transfers through the clayey sands.

452 The results obtained on frozen soil show that at the same temperature, thermal conductivity
453 measured on the thawing path was slightly higher than that on the freezing path (Fig. 6 and
454 Fig. 7b). In the work of Zhang et al. (2018), similar trend was observed on unsaturated silty
455 clay compacted at a dry density of 1.50 Mg/m^3 while inverse trend was observed at a dry
456 density of 1.75 Mg/m^3 for the same range of temperature (between 0 and $-5 \text{ }^\circ\text{C}$). Zhang et al.
457 (2018) explained these trends by mentioning two factors: the change of soil density after a
458 freezing-thawing cycle and hysteresis of the soil freezing characteristics curve. In the present
459 work, as the experiments were conducted in a rigid metallic cell, the change of soil density
460 could be ignored. Thus, at a given temperature, volumetric water content was lower on the
461 thawing path (ice content was higher, see more details on the soil freezing characteristic
462 curves of these soils in Vu et al. 2022), which induced a higher thermal conductivity.

463 Thermal conductivity of unfrozen soils is mostly controlled by water content. The
464 measurements of this study are supplemented by the data from Zhang et al. (2017) not only in
465 the range of high degree of saturation, but also at various porosities. Regarding the plateau of
466 λ in the high range of S_w (higher than 60%), considering that the soils in the present study are
467 dense, it can be explained by a low weighted factor of heat transfer in the pores filled with

468 water and air. In this range of high degree of saturation, it is believed that heat conduction
469 between sand grains through their contact (water) is dominant while the other heat transfer
470 modes, such as conduction in air, radiation in air, convection in air, or vapour diffusion are
471 not significant. λ could decrease only when the amount of water improving the connection
472 between sand grains decreases due to drying process. The later mechanism is observed in Fig.
473 11 where significant decrease of λ in the range of low water degree of saturation follows a
474 nonlinear trend. In addition, for each clay content, the porosity also considerably influences λ .
475 The effect of porosity is also clearly demonstrated by many studies (Chen, 2008; Smits et al.,
476 2010; Tarnawski et al., 2009). The increase of volume of sand grains characterized by the
477 highest λ among the soil components along with decreasing volume of water with low λ
478 contributes to a significant increase of λ of soils.

479 Johansen's model gave a good prediction for unfrozen soils except S15-D1 (fairly good)
480 while De Vries's model gave a fairly good prediction only for S20-D1. Johansen's model,
481 within $\kappa = 8$ for all different soils, showed more accurate prediction of measurements than
482 proposed formula of κ based on quartz content in the study of Zhang et al. (2017). The
483 formula could consider the influence of porosity of soils for better prediction.

484 In this study, increasing clay contents increases λ in unfrozen state but an opposite trend is
485 almost observed in frozen state. Considering that the sand skeleton is approximately formed
486 by its optimum structure in terms of limiting pore volume by means of Proctor procedure,
487 adding clay would fill the pores between sand grains. Available space for water is thus
488 reduced by the presence of clay. Due to the replacement of water with $\lambda_w = 0.57$ W/(m.K) by
489 clay with higher thermal conductivity $\lambda_c = 2.44$ W/(m.K), increasing clay content increases
490 the thermal conductivity at unfrozen state. In frozen state, the opposite trend is almost

491 observed because of the transformation of liquid water into ice. Actually, while S0-T1
492 contains pure sand and almost 37% of total soil volume (Table 2) (corresponding to $S_r = 0.5\%$
493 at frozen state as shown in Fig. 8) is filled with ice at frozen state, S20-T1 with 20% clay in
494 solid volume (solids are sand and clay) contains only 21% (corresponding to $S_r = 20\%$ and
495 26% of porosity) of total soil volume filled by ice at frozen state. It is noted that at higher clay
496 contents, more water is kept unfrozen due to the presence of capillary and bound water which
497 could not be frozen at temperatures close to 0 °C. By comparing two extreme cases in this
498 study, it is clear that adding clay in soils not only decreases the available volume for ice in the
499 soils' porosity, but also increases unfrozen water content in frozen state. Consequently, soils
500 with lower clay content have lower λ at unfrozen state but higher λ at frozen state.

501 **6. Conclusions**

502 The variation of clay content (from 0 to 20 %) in sandy soils significantly influences thermal
503 conductivity of soils in both freezing-thawing and drying-wetting processes. Based on the
504 obtained results, some conclusions can be summarized as follows:

- 505 - In freezing-thawing process of saturated soils, thermal conductivity in frozen state is
506 considerably higher than that in unfrozen state. The thermal conductivity of frozen
507 soils is higher at a lower unfrozen water content.
- 508 - For frozen soil, to provide the same thermal conductivity, volumetric unfrozen water
509 content has to be higher for a higher clay content.
- 510 - For unfrozen soil, at a given volumetric water content, thermal conductivity of soils is
511 higher at a higher clay content.

512 - Johansen's model and De Vries's model cannot predict well thermal conductivity of
513 soil in freezing-thawing process in the studied range of temperature. The models need
514 further improvement for better prediction.

515 - Johansen's model can predict satisfactorily the thermal conductivity in drying-wetting
516 process but not De Vries's model.

517 The findings of the present study could be helpful for various engineering applications
518 such as artificial ground freezing or cold regions geo-technologies. In these applications,
519 soils can exist in both unfrozen and frozen states and the effects of clay content on thermal
520 conductivity of sandy soils should be considered when analysing thermal transfers in the
521 ground.

522 **Competing interests**

523 The authors declare there are no competing interests.

524 **Author contribution**

525 Q.H. Vu: Writing – original draft; Data Curation; Formal Analysis; Investigation;
526 Methodology; Visualization. J.M. Pereira: Conceptualization; Project administration;
527 Supervision; Validation; Writing – review & editing. A.M. Tang: Conceptualization; Project
528 administration; Supervision; Validation; Writing – review & editing.

529 **Funding**

530 The authors declare no specific funding for this work.

531 **Data availability**

532 Data generated or analysed during this study are available from the corresponding author
533 upon reasonable request.

534 **References**

535 Abu-Hamdeh, N.H., 2003. Thermal properties of soils as affected by density and water
536 content. *Biosyst. Eng.* 86, 97–102. [https://doi.org/10.1016/S1537-5110\(03\)00112-0](https://doi.org/10.1016/S1537-5110(03)00112-0)

537 Abu-Hamdeh, N.H., Reeder, R.C., 2000. Soil thermal conductivity effects of density,
538 moisture, salt concentration, and organic matter. *Soil Sci. Soc. Am. J.* 64, 1285–1290.
539 <https://doi.org/10.2136/sssaj2000.6441285x>

540 Andersland, O.B., Ladanyi, B., 2004. *Frozen Ground Engineering*. John Wiley & Sons.

541 Birchak, J.R., Gardner, C.G., Hipp, J.E., Victor, J.M., 1974. High dielectric constant
542 microwave probes for sensing soil moisture. *Proc. IEEE* 62, 93–98.
543 <https://doi.org/10.1109/PROC.1974.9388>

544 Bonales, L.J., Rodriguez, A.C., Sanz, P.D., 2017. Thermal conductivity of ice prepared under
545 different conditions. *Int. J. Food Prop.* 20, S610–S619.
546 <https://doi.org/10.1080/10942912.2017.1306551>

547 Boussaid, K., 2005. *Sols intermédiaires pour la modélisation physique : application aux*
548 *fondations superficielles*. École Centrale de Nantes et Université de Nantes.

549 Bristow, K.L., 1998. Measurement of thermal properties and water content of unsaturated
550 sandy soil using dual-probe heat-pulse probes. *Agric. For. Meteorol.* 89, 75–84.
551 [https://doi.org/10.1016/S0168-1923\(97\)00065-8](https://doi.org/10.1016/S0168-1923(97)00065-8)

- 552 Chen, S.X., 2008. Thermal conductivity of sands. *Heat Mass Transf. und Stoffuebertragung*
553 44, 1241–1246. <https://doi.org/10.1007/s00231-007-0357-1>
- 554 Côté, J., Konrad, J.-M., 2005a. A generalized thermal conductivity model for soils and
555 construction materials. *Can. Geotech. J.* 42, 443–458. <https://doi.org/10.1139/T04-106>
- 556 Côté, J., Konrad, J.M., 2005b. Thermal conductivity of base-course materials. *Can. Geotech.*
557 *J.* 42, 61–78. <https://doi.org/10.1139/t04-081>
- 558 Cui, F.Q., Liu, Z.Y., Chen, J.B., Dong, Y.H., Jin, L., Peng, H., 2020a. Experimental test and
559 prediction model of soil thermal conductivity in permafrost regions. *Appl. Sci.* 10.
560 <https://doi.org/10.3390/app10072476>
- 561 Cui, F.Q., Zhang, W., Liu, Z.Y., Wang, W., Chen, J.B., Jin, L., Peng, H., 2020b. Assessment
562 for thermal conductivity of frozen soil based on nonlinear regression and support vector
563 regression methods. *Adv. Civ. Eng.* 2020. <https://doi.org/10.1155/2020/8898126>
- 564 De Vries, D.A., 1963. Thermal properties of soils. *Phys. plant Environ.*
- 565 Farouki, O.T., 1986. *Thermal Properties of Soils*, Ser. *Rock Soil Mech.*, vol. 11. Trans Tech,
566 Clausthal-Zellerfeld, Ger.
- 567 Haynes, W.M., 2016. *CRC Handbook of Chemistry and Physics*, 97th ed. CRC press.
- 568 He, H., Dyck, M., 2013. Application of multiphase dielectric mixing models for
569 understanding the effective dielectric permittivity of frozen soils. *Vadose Zo. J.* 12.
570 <https://doi.org/10.2136/vzj2012.0060>
- 571 He, H., Flerchinger, G.N., Kojima, Y., Dyck, M., Lv, J., 2021. A review and evaluation of 39

572 thermal conductivity models for frozen soils. *Geoderma* 382, 114694.
573 <https://doi.org/10.1016/j.geoderma.2020.114694>

574 Ji, Y., Zhu, K., Lyu, C., Wang, S., Ning, D., Fan, J., Shi, L., 2021. Semiempirical Correlation
575 between P-Wave Velocity and Thermal Conductivity of Frozen Silty Clay Soil. *Shock*
576 *Vib.* 2021, 1–7. <https://doi.org/10.1155/2021/5533696>

577 Johansen, O., 1977. Thermal conductivity of soils. US Army Corps Eng. University of
578 Trondheim, Trondheim, Norway.

579 Johansson, T., 2009. Artificial ground freezing in clayey soils. KTH Architecture and Built
580 Environment.

581 Kersten, M.S., 1949. Thermal properties of soils. University of Minnesota.

582 Kim, H.-S., Lee, J.-G., Kang, J.-M., Kim, Y.-S., Hong, S.-S., 2011. Thermal Conductivity of
583 Saturated Unfrozen Kaolinite during Consolidation. *J. Eng. Geol.* 21, 157–162.

584 Lawson, A.W., Lowell, R., Jain, A.L., 1959. Thermal Conductivity of Water at High
585 Pressures. *J. Chem. Phys.* 30, 643–647. <https://doi.org/10.1063/1.1730024>

586 Li, Z., Chen, J., Sugimoto, M., 2020. Pulsed NMR Measurements of Unfrozen Water Content
587 in Partially Frozen Soil. *J. Cold Reg. Eng.* 34, 04020013.
588 [https://doi.org/10.1061/\(ASCE\)CR.1943-5495.0000220](https://doi.org/10.1061/(ASCE)CR.1943-5495.0000220)

589 Lu, Y., Yu, W., Hu, D., Liu, W., 2018. Experimental study on the thermal conductivity of
590 aeolian sand from the Tibetan Plateau. *Cold Reg. Sci. Technol.* 146, 1–8.
591 <https://doi.org/10.1016/j.coldregions.2017.11.006>

592 Mickley, A.S., 1951. The Thermal Conductivity of Moist Soil. *Trans. Am. Inst. Electr. Eng.*
593 70, 1789–1797. <https://doi.org/10.1109/T-AIEE.1951.5060631>

594 Nagare, R.M., Schincariol, R.A., Quinton, W.L., Hayashi, M., 2011. Laboratory calibration of
595 time domain reflectometry to determine moisture content in undisturbed peat samples.
596 *Eur. J. Soil Sci.* 62, 505–515. <https://doi.org/10.1111/j.1365-2389.2011.01351.x>

597 Nguyen, V.T., Heindl, H., Pereira, J.M., Tang, A.M., Frost, J.D., 2017. Water retention and
598 thermal conductivity of a natural unsaturated loess. *Géotechnique Lett.* 7, 286–291.
599 <https://doi.org/10.1680/jgele.17.00037>

600 Penner, E., 1970. Thermal conductivity of frozen soils. *Can. J. Earth Sci.* 7, 982–987.
601 <https://doi.org/10.1139/e70-091>

602 Penner, E., Johnston, G.H., Goodrich, L.E., 1975. Thermal conductivity laboratory studies of
603 some Mackenzie Highway Soils. *Can. Geotech. J.* 12, 271–288.

604 Roth, K., Schulin, R., Fluhler, H., Attinger, W., 1990. Calibration of time domain
605 reflectometry for water content measurement using a composite dielectric approach.
606 *Water Resour. Res.* 26, 2267–2273.

607 Schafer, H., Beier, N., 2020. Estimating soil-water characteristic curve from soil-freezing
608 characteristic curve for mine waste tailings using time domain reflectometry. *Can.*
609 *Geotech. J.* 57, 73–84. <https://doi.org/10.1139/cgj-2018-0145>

610 Sepaskhah, A.R., Boersma, L., 1979. Thermal Conductivity of Soils as a Function of
611 Temperature and Water Content. *Soil Sci. Soc. Am. J.* 43, 439–444.
612 <https://doi.org/10.2136/sssaj1979.03615995004300030003x>

- 613 Slack, G.A., 1980. Thermal conductivity of ice. *Phys. Review B* 22, 3065.
- 614 Smith, M.W., Tice, A.R., 1988. Measurement of the unfrozen water content of soils:
615 comparison of NMR and TDR methods, *Cold Regions Reserach and Engineering*
616 *Laboratory*. Hanover.
- 617 Smits, K.M., Sakaki, T., Limsuwat, A., Illangasekare, T.H., 2010. Thermal Conductivity of
618 Sands under Varying Moisture and Porosity in Drainage–Wetting Cycles. *Vadose Zo. J.*
619 9, 172. <https://doi.org/10.2136/vzj2009.0095>
- 620 Spaans, E.J. a, Baker, J.M., 1995. Examining the use of time domain refiectometry for
621 measuring liquid water content in frozen soil. *Water Resour. Res.* 31, 2917–2925.
622 <https://doi.org/10.1029/95WR02769>
- 623 Stähli, M., Stadler, D., 1997. Measurement of water and solute dynamics in freezing soil
624 columns with time domain reflectometry. *J. Hydrol.* 195, 352–369.
625 [https://doi.org/10.1016/S0022-1694\(96\)03227-1](https://doi.org/10.1016/S0022-1694(96)03227-1)
- 626 Tang, A.M., Cui, Y.J., Le, T.T., 2008. A study on the thermal conductivity of compacted
627 bentonites. *Appl. Clay Sci.* 41, 181–189. <https://doi.org/10.1016/j.clay.2007.11.001>
- 628 Tarnawski, V.R., Leong, W.H., 2000. Thermal conductivity of soils at very low moisture
629 content and moderate temperatures. *Transp. Porous Media* 41, 137–147.
630 <https://doi.org/10.1023/A:1006738727206>
- 631 Tarnawski, V.R., Momose, T., Leong, W.H., Bovesecchi, G., Coppa, P., 2009. Thermal
632 Conductivity of Standard Sands. Part I. Dry-State Conditions. *Int. J. Thermophys.* 30,
633 949–968. <https://doi.org/10.1007/s10765-009-0596-0>

- 634 Tarnawski, V.R., Momose, T., McCombie, M.L., Leong, W.H., 2015. Canadian Field Soils
635 III. Thermal-Conductivity Data and Modeling. *Int. J. Thermophys.* 36, 119–156.
636 <https://doi.org/10.1007/s10765-014-1793-z>
- 637 Tarnawski, V.R., Wagner, B., 1992. A new computerized approach to estimating the thermal
638 properties of unfrozen soils. *Can. Geotech. J.* 29, 714–720. <https://doi.org/10.1139/t92->
639 079
- 640 Tian, H., Wei, C., Wei, H., Zhou, J., 2014. Freezing and thawing characteristics of frozen
641 soils: Bound water content and hysteresis phenomenon. *Cold Reg. Sci. Technol.* 103,
642 74–81. <https://doi.org/10.1016/j.coldregions.2014.03.007>
- 643 Tian, Z., Lu, Y., Horton, R., Ren, T., 2016. A simplified de Vries-based model to estimate
644 thermal conductivity of unfrozen and frozen soil. *Eur. J. Soil Sci.* 67, 564–572.
645 <https://doi.org/10.1111/ejss.12366>
- 646 Tian, Z., Ren, T., Kojima, Y., Lu, Y., Horton, R., Heitman, J.L., 2017. An improved thermo-
647 time domain reflectometry method for determination of ice contents in partially frozen
648 soils. *J. Hydrol.* 555, 786–796. <https://doi.org/10.1016/j.jhydrol.2017.10.055>
- 649 Tice, A.R., Anderson, D.M., Banin, A., 1976. The prediction of unfrozen water contents in
650 frozen soils from liquid limit determinations 76.
- 651 Topp, G.C., Davis, J.L., Annan, A.P., 1980. Electromagnetic determination of soil water
652 content: Measurements in coaxial transmission lines. *Water Resour. Reserch* 16, 574–
653 582.
- 654 Vieira, A., Maranhã, J.R., Lapa, J., Figueiredo, A., 2019. Some aspects of measurement of

655 sand thermal conductivity from laboratory tests. Proc. XVII ECSMGE.
656 <https://doi.org/10.32075/17ECSMGE-2019-0541>

657 Vu, Q.H., Pereira, J.M., Tang, A.M., 2022. Effect of fines content on soil freezing
658 characteristic curve of sandy soils. Acta Geotech. 17, 4921–4933.
659 <https://doi.org/10.1007/s11440-022-01672-9>

660 Wang, J., He, H., Dyck, M., Lv, J., 2020. A review and evaluation of predictive models for
661 thermal conductivity of sands at full water content range. Energies 13.
662 <https://doi.org/10.3390/en13051083>

663 Watanabe, K., Wake, T., 2009. Measurement of unfrozen water content and relative
664 permittivity of frozen unsaturated soil using NMR and TDR. Cold Reg. Sci. Technol. 59,
665 34–41. <https://doi.org/10.1016/j.coldregions.2009.05.011>

666 Wraith, J.M., Or, D., 1999. Temperature effects on soil bulk dielectric permittivity measured
667 by time domain reflectometry: Experimental evidence and hypothesis development.
668 Water Resour. Res. 35, 361–369.

669 Yan, H., He, H., Dyck, M., Jin, H., Li, M., Si, B., Lv, J., 2019. A generalized model for
670 estimating effective soil thermal conductivity based on the Kasubuchi algorithm.
671 Geoderma 353, 227–242. <https://doi.org/10.1016/j.geoderma.2019.06.031>

672 Zhang, M., Lu, J., Lai, Y., Zhang, X., 2018. Variation of the thermal conductivity of a silty
673 clay during a freezing-thawing process. Int. J. Heat Mass Transf. 124, 1059–1067.
674 <https://doi.org/10.1016/j.ijheatmasstransfer.2018.02.118>

675 Zhang, M., Zhang, X., Lai, Y., Lu, J., Wang, C., 2020. Variations of the temperatures and

676 volumetric unfrozen water contents of fine-grained soils during a freezing–thawing
677 process. *Acta Geotech.* 15, 595–601. <https://doi.org/10.1007/s11440-018-0720-z>

678 Zhang, N., Yu, X., Pradhan, A., Puppala, A.J., 2017. A new generalized soil thermal
679 conductivity model for sand–kaolin clay mixtures using thermo-time domain
680 reflectometry probe test. *Acta Geotech.* 12, 739–752. [https://doi.org/10.1007/s11440-](https://doi.org/10.1007/s11440-016-0506-0)
681 [016-0506-0](https://doi.org/10.1007/s11440-016-0506-0)

682 Zhang, N., Yu, X., Pradhan, A., Puppala, A.J., 2015. Effects of particle size and fines content
683 on thermal conductivity of Quartz sands. *Transp. Res. Rec.* 2510, 36–43.
684 <https://doi.org/10.3141/2510-05>

685 Zhao, X., Zhou, G., Jiang, X., 2019. Measurement of thermal conductivity for frozen soil at
686 temperatures close to 0 °C. *Meas. J. Int. Meas. Confed.* 140, 504–510.
687 <https://doi.org/10.1016/j.measurement.2019.03.069>

688 Zhao, Y., Si, B., 2019. Thermal properties of sandy and peat soils under unfrozen and frozen
689 conditions. *Soil Tillage Res.* 189, 64–72. <https://doi.org/10.1016/j.still.2018.12.026>

690 Zhou, X., Zhou, J., Kinzelbach, W., Stauffer, F., 2014. Simultaneous measurement of
691 unfrozen water content and ice content in frozen soil using gamma ray attenuation and
692 TDR. *Water Resour. Res.* 50, 9630–9655. <https://doi.org/10.1002/2014WR015640>

693

694

695 **Table captions**

696 Table 1. Physical properties of Speswhite Kaolin clay and Fontainebleau sand (Boussaid,
697 2005).

698 Table 2. Physical properties of soils in freezing-thawing (T1) and drying-wetting (D1)
699 experiments.

700 Table 3. Properties of sensors used in freezing-thawing and drying-wetting experiments.

701

702

703

704

705

706

707

708

709

710

711

712

713

714

715

716

717

718

719

720

721

722 **Figure captions**

723 Fig. 1 Grain size distribution curves.

724 Fig. 2. Setup for freezing-thawing experiment: (1) Temperature-controlled bath; (2) Soil
725 specimen; (3) Temperature control system; (4) Heat transfer liquid (30% ethylene glycol +
726 70% water); (5) Metallic cylindrical cell; (6) Insulating cover; (7) Temperature sensor; (8)
727 Tensiometer; (9) Soil water content sensor; (10) Thermal conductivity probe; (11) Data
728 logging system.

729 Fig. 3. Setup of drying-wetting experiment: (1) Soil; (2) Metallic cylindrical cell; (3)
730 Insulating cover; (4) Tensiometer; (5) Thermal conductivity probe; (6) Soil water content
731 sensor; (7) Data logging system.

732 Fig. 4. Temporal variation of temperature, unfrozen volumetric water content and thermal
733 conductivity during test S10-T1.

734 Fig. 5. Relationships between thermal conductivity, temperature and volumetric unfrozen
735 water content of test S10-T1.

736 Fig. 6. Thermal conductivity versus temperature for all freezing-thawing experiments.

737 Fig. 7. Thermal conductivity versus (a) volumetric unfrozen water content and (b) temperature
738 for all freezing-thawing experiments.

739 Fig. 8. Experimental results and models' prediction for thermal conductivity versus water
740 degree of saturation: (a) S0-T1; (b) S05-T1; (c) S10-T1; (d) S15-T1; (e) S20-T1.

741 Fig. 9. Volumetric water content and thermal conductivity of unfrozen soils in wetting drying
742 process of S10-D1.

743 Fig. 10. Thermal conductivity versus water degree of saturation for all drying-wetting
744 experiments.

745 Fig. 11. Experimental results (obtained in this study and in the study of N. Zhang et al., 2017)
746 and models prediction for thermal conductivity versus degree of saturation: (a) S0; (b) S5; (c)
747 S10; (d) S15; (e) S20.

748 Fig. 12. Configuration of soil media in (a) unfrozen saturated state, (b) frozen saturated state
749 and (c) unfrozen unsaturated state.

750