



HAL
open science

Cement with bacterial nanocellulose cured at reservoir temperature: Mechanical performance in the context of CO₂ geological storage

Juan Cruz Barría, Diego Manzanal, Patricia Cerruti, Jean-Michel Pereira

► To cite this version:

Juan Cruz Barría, Diego Manzanal, Patricia Cerruti, Jean-Michel Pereira. Cement with bacterial nanocellulose cured at reservoir temperature: Mechanical performance in the context of CO₂ geological storage. *Geomechanics for Energy and the Environment*, 2022, 30, pp.100267. 10.1016/j.gete.2021.100267. hal-03358109

HAL Id: hal-03358109

<https://enpc.hal.science/hal-03358109>

Submitted on 29 Sep 2021

HAL is a multi-disciplinary open access archive for the deposit and dissemination of scientific research documents, whether they are published or not. The documents may come from teaching and research institutions in France or abroad, or from public or private research centers.

L'archive ouverte pluridisciplinaire **HAL**, est destinée au dépôt et à la diffusion de documents scientifiques de niveau recherche, publiés ou non, émanant des établissements d'enseignement et de recherche français ou étrangers, des laboratoires publics ou privés.

1 **Cement with bacterial nanocellulose cured at reservoir temperature:**
2 **mechanical performance in the context of CO₂ geological storage**

3 **Juan Cruz Barría^{1,5}, Diego Manzanal^{1,2,*}, Patricia Cerruti^{3,4}, Jean-Michel**
4 **Pereira⁵**

5 ¹ Facultad de Ingeniería, Universidad Nacional de la Patagonia San Juan Bosco, 9004 Comodoro
6 Rivadavia, Chubut, Argentina.

7 ² E.T.S.I. Caminos, Universidad Politécnica de Madrid, Prof. Aranguren 3, 28040 Madrid, Spain.

8 ³ Instituto de Tecnología en Polímeros y Nanotecnología (ITPN), Grupo de Biotecnología y
9 Materiales Biobasados, Universidad de Buenos Aires (UBA), CONICET, Facultad de Ingeniería, Las
10 Heras 2214 (1127), Buenos Aires, Argentina.

11 ⁴ Universidad de Buenos Aires, Facultad de Ingeniería, Departamento de Ingeniería Química, Av.
12 Intendente Güiraldes 2620 (1428) – Pabellón de Industrias, Ciudad Universitaria, Buenos Aires,
13 Argentina.

14 ⁵ Navier, Ecole des Ponts, Univ Gustave Eiffel, CNRS, Marne-la-Vallée, France.

15 *Correspondence to d.manzanal@upm.es

16
17 **Abstract**

18 Storing CO₂ in deep underground reservoirs is key to reducing emissions to the atmosphere and
19 standing against climate change. However, the risk of CO₂ leakage from geological reservoirs to
20 other rock formations requires a careful long-term analysis of the system. Especially, oil well cement
21 used for the operation must withstand the carbonation process that changes its poromechanical
22 behavior over time, possibly affecting the system's integrity.

23 This work focuses on the microstructure and mechanical behavior of cement modified with bacterial
24 nanocellulose (BNC) cured at 90 °C, simulating temperature at the reservoir level. The chemo-
25 hydro-mechanical (CHM) coupled behavior of the cement-rock interface is also investigated through
26 numerical analyses.

27 Mercury intrusion porosimetry (MIP), X-ray diffraction (XRD), ultrasonic wave measures, and
28 unconfined compressive strength (UCS) tests were performed on cement samples subjected to a
29 supercritical CO₂ environment. After carbonation, BNC samples show a lower mass gain and lower
30 porosity compared to PC. Permeability based on MIP results indicates that the BNC reduces the
31 permeability of the specimen. XRD quantification shows no substantial difference between the
32 crystalline phases of the two samples. Samples with BNC have lower absolute strength but higher
33 relative increase during carbonation.

34 The numerical study includes a homogenization of the medium considering the contribution of all
35 components. CHM behavior of the cement with BNC is analyzed, and the results show the variations
36 of the physical and chemical properties across the sample. The numerical study shows the
37 advantage of using this type of tool for the study of realistic CO₂ injection scenarios in deep wells.

38 **Keywords**

39 CO₂ geological storage, cement paste, bacterial nanocellulose, reservoir temperature, chemo-
40 hydro-mechanical couplings.

41 **1. Introduction**

42 There is an increasing rate of greenhouse gas emissions into the atmosphere. This can have
43 consequences for different ecosystems and human health¹. The carbon dioxide capture and storage
44 (CCS) technology is an effective solution to reduce these emissions of CO₂². This technology allows
45 storing massive amounts of CO₂ underground in geological reservoirs^{3,4}. It is important to know the
46 storage capacity of the reservoir, but this highly depends on temperature and pressure. Reservoirs
47 deep enough to store CO₂ in a supercritical state (scCO₂) present considerably higher capacities
48 compared to shallower reservoirs with similar pore volume. Furthermore, high pressures and
49 temperatures just above the supercritical point considerably increase the fluid density, and therefore
50 the amount of CO₂ that can be stored². Other key factors are the porosity and permeability of the
51 reservoir rock. For instance, the “Sicily Channel” and “Abruzzi Offshore” reservoirs are candidates
52 for geological storage, with porosities reaching 25.6% and permeability of 358 mD⁵. On the other
53 hand, shale formations can also be considered for storage of CO₂, as indicated by studies on the
54 SACROC Unit reservoir, since shale rock have porosities of around 10% and permeability of 10-100
55 mD, ensuring that their sealing capacity can be maintained for decades⁶.

56 The caprock formation is an impermeable barrier that covers the upper part of the reservoir and
57 prevents CO₂ leakage to other geological formations. However, during drilling, the zone near the
58 well is damaged. Existing or drilling-induced faults/fractures in the caprock could turn into leakage
59 paths of CO₂ to upper environments. An annular cement barrier is placed between the steel casing
60 and the rock formation to maintain the wellbore integrity after the drilling fluids are removed.

61 Several problems arise in this system during CO₂ injection, two of which are temperature gradients⁷
62 and induced seismic activity⁸. These effects change the stress states and can lead to failure of the
63 cement or rock. Furthermore, cement Class G used in the oil industry is chemically unstable against

64 CO₂ and scCO₂⁹. Geochemical studies of cement paste show that the advance of carbonic acid
65 through cement paste mainly induces the chemical reaction of portlandite (CH) and hydrated calcium
66 silicates (C-S-H), and the precipitation of calcium carbonate (CC)¹⁰. These chemical reactions
67 induce changes in porosity and the mineral composition of the solid phase. The first reaction of
68 carbonation in cement is between CH and CO₂:



70 In absence of CH, the pH level is significantly reduced, allowing the second reaction that consists of
71 the carbonation of the C-S-H:

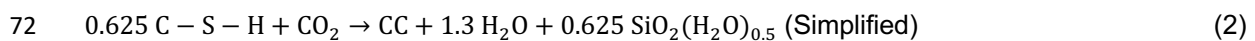

73 The formation of amorphous silica from C-S-H could increase porosity, depending on the C-S-H
74 structure¹¹, and may reduce structural integrity. Furthermore, CaCO₃ precipitated in a water acidified
75 medium in the presence of CO₂ is in turn prone to dissolution¹². This dissolution continues until
76 thermodynamic equilibrium is reached¹³, increasing porosity, permeability, and reducing
77 compressive strength¹⁴. The cement matrix, after complete carbonation and degradation, may result
78 in a porous medium of low resistance, unable to maintain the integrity of the borehole or the ability
79 to seal against external loads^{15,16}.

80 The modification of cement to improve some properties is a subject of interest in the cement wellbore
81 industry. The objective is to modify the cement matrix, making it lighter while maintaining high
82 strength and low permeability in its hardened state. New additives such as nanocellulose are being
83 added to the mix to improve the cement properties¹⁷. Nanocellulose can be used as a crack-inhibitor
84 to avoid cement damage and thus prevent CO₂ leakage through the upper formations^{18,19}. Bacterial
85 nanocellulose (BNC) is a type of nanocellulose obtained from bacteria of the genus
86 *Gluconacetobacter*. This material is produced by a partner company, and obtained in a more
87 economical and less polluting way than other polymers²⁰. Nanocellulose is considered as a potential
88 additive to improve cement properties, such as mechanical and thermal resistance, and to decrease
89 transport phenomena by reducing cement porosity²¹⁻²³. In turn, its use can be extended in the oil
90 industry in cementing operations.

91 The effect of bacterial nanocellulose (BNC) on the porosity and mechanical behavior of oil well
92 cement paste cured at 20°C and atmospheric pressure has been recently studied^{22,24}. Barria et al.²²
93 show that BNC increases compressive strength and thermal stability in non-carbonated samples.

94 BNC-cement samples subjected to scCO₂ conditions show a density increase and a reduction in
95 porosity, while the carbonation degree is reduced, therefore the mechanical behavior is less affected
96 compared to non-modified cement²⁴. Nevertheless, its behavior at different curing conditions like
97 those in a reservoir is unknown.

98 Temperatures in the various geological reservoirs (coal beds, deep saline aquifers, or depleted oil
99 and gas reservoirs) can vary depending on the depth at which they are found. In some reservoirs,
100 the temperature can vary from 60 to 160 °C²⁵, being 90 °C a value usually used by other authors
101 experimenting with cement^{26–29}.

102 This work focuses on the microstructure and mechanical changes of cement pastes with added
103 bacterial nanocellulose and cured at 90 °C in the context of CO₂ reservoir conditions. Mercury
104 intrusion porosimetry (MIP), X-ray diffraction (XRD), ultrasonic wave measurement, and unconfined
105 compressive strength (UCS) tests were performed on BNC-cement samples subjected to
106 supercritical CO₂ conditions to characterize its behavior. A finite-element-based numerical analysis
107 of the chemo-hydro-mechanical (CHM) coupled behavior of the cement-rock interface accounting
108 for the obtained experimental data is then carried out to explore realistic scenarios of CO₂ injection
109 in deep wells.

110 **2. Experimental program**

111 Cement samples modified with bacterial nanocellulose were cured at 90 °C, simulating temperature
112 at reservoir level prior to being carbonated under wet supercritical CO₂ conditions. Porosimetry and
113 mechanical tests were performed on these samples to study the evolution of the microstructure and
114 mechanical behavior.

115 **2.1 Materials**

116 The cement used in this study was Class G Portland Cement. The cement composition obtained by
117 X-ray fluorescence is C₃S 52.8%, C₃A 1.6%, C₂S 21.1% and C₄AF 15.5%²².

118 Bacterial nanocellulose (BNC) used is a biopolymer derived from the aerobic fermentation of
119 bacteria of the genus *Gluconacetobacter*³⁰. This biopolymer is a membrane with 98% of water and
120 2% of bacterial nanocellulose. The membrane is formed by micrometric fibers of nanometric
121 thickness. Deionized water and a polycarboxylate ADVA 175 LN High-Performance Water-Reducing
122 Admixture were used in the mixture.

123 **2.2 Preparation of cement samples**

124 Bacterial nanocellulose additive was prepared by grinding the BNC membranes and using
125 ultrasound to generate a homogeneous fluid²². Cement mixtures were made following the American
126 Petroleum Institute (API) Standard 10A³¹ and pouring the slurry in cylindrical molds. They were
127 cured in a 90 °C batch, unmolded after 24 hours, and kept underwater for 48 hours. They were then
128 dried at 85 °C for 1 week²⁶, simulating a dry cure in the wellbore. A group of 16 samples; 8 non-
129 modified cement (PC) and 8 with 0.05% of BNC (BNC05) were prepared and cored with a diamond
130 wire saw into 76 mm long cylinders with a diameter of 38 mm each.

131 2.3 Carbonation

132 The accelerated carbonation under wet supercritical CO₂ conditions was carried out in a vessel of
133 4020 cm³ of volume at 90 °C and 20 MPa for 30 days. The samples were placed on a container grid
134 inside the cell. 500 ml of water were placed at the bottom of the vessel to maintain humidity. First,
135 the vessel was pressurized with CO₂ until 8 MPa. Then, the temperature of the vessel was raised to
136 90 °C and the pressure was regulated until 20 MPa. These conditions were maintained during the
137 entire test. Once the test finished, the heating system was turned off and the pressure was slowly
138 released until atmospheric pressure. **Fig. 1** shows the equipment used. 4 Portland Cement (PC)
139 samples and 4 modified cement samples with 0.05% BNC (BNC05) were carbonated for 30 days.

140 2.4 Porosimetry measurement and permeability estimation.

141 The pore size distributions of the BNC-cement samples were characterized by means of mercury
142 intrusion porosimetry (MIP). The AutoPore IV 9500 Micromeritics with a maximum pressure of 230
143 MPa was used to measure pore sizes between 5 nm and 300 μm. Samples of approximately 1 cm³
144 were taken from a representative zone of the non-carbonated cement samples and, in the case of
145 the carbonated cement, samples were taken from the core and the most degraded zone near the
146 exposed surface. Before testing, samples were dried by the freeze-drying method.

147 The effect of curing the samples in the oven (Section 2.2) for 1 week was measured. For this
148 purpose, air-cured samples (PC-Reference) and oven-cured samples (PC-NC and BNC05-NC)
149 were compared. NC means non-carbonated samples, while 30INT and 30EXT are 30-days
150 carbonated samples located at the interior and exterior of the bulk sample, respectively. The tests
151 performed are listed in **Table 1**.

152 By assuming cylindrical interconnected pores, we can calculate the pore diameter corresponding to
153 each mercury pressure step by:

$$154 \quad p = \frac{4\gamma \cos(\theta)}{d} \quad (3)$$

155 where γ = mercury surface tension = 0.485 N/m, θ = mercury contact angle = 130° ³², p = mercury
156 pressure, d = pore diameter.

157 An estimate of permeability can be made from the results obtained in the MIP test. This estimation
158 is performed by considering the macro-scale flow with Darcy's law and the micro-scale flow with
159 Poiseuille's law.

160 Each pore of class i of diameter d_i has an intrusion volume of mercury V_i , so a length L_i can be
161 determined for each pore class i :

$$162 \quad L_i = \frac{4V_i}{\pi d_i^2} \quad (4)$$

163 Assuming laminar flow, the Poiseuille's flow in a cylindrical tube depends on the difference of
164 pressures at the tube ends, the dimensions of the tube, and the viscosity of the fluid. So the flow for
165 each tube of diameter d_i is:

$$166 \quad Q_{\text{Poiseuille}} = \frac{\Delta V}{\Delta t} = \frac{\Delta P_i (\pi d_i^4)}{128 L_i \eta} \quad (5)$$

167 Where ΔP_i is every mercury pressure step and η is the dynamic viscosity of the fluid.

168 Once the total flow rate is obtained, Darcy's law can be used to determine the permeability at the
169 macro-scale. Let V_t be the total apparent volume of the MIP sample (ratio of total pore volume to
170 porosity). The average pore length L_e is defined as:

$$171 \quad L_e = \sqrt[3]{V_t} \quad (6)$$

172 The hydraulic gradient i is given by:

$$173 \quad i = \frac{\Delta P_t}{L_e} \quad (7)$$

174 Where ΔP_t is the total pressure increase in meters' water column measured in the MIP.

175 Therefore, the intrinsic permeability of the material (independent of fluid conditions) is:

$$176 \quad \kappa = \frac{\sum_i^n Q_{\text{Poiseuille}}}{S_i} \left(\frac{\eta}{\rho_f g} \right) \quad (8)$$

177 Where n is the total number of pores of different diameters, S is the cross-section of a cubic
178 specimen with sides of length L_e , ρ_f is the density of the fluid and g is the gravity.

179 The calculated permeability accounts for an isotropic flux in a cubic sample. Hence, it needs to be
180 divided by three to compare with the directional permeability obtained experimentally. This indicates
181 that the fluid flows equally in the three directions of space³³.

182 The specimens analyzed to calculate permeability were carbonated and non-carbonated samples
183 of both types of cement (PC-NC, PC-30EXT, BNC05-NC, BNC05-30EXT).

184 2.5 X-ray diffraction (XRD)

185 X-ray diffractograms were obtained in a Philips 3020 diffractometer using CuK α radiation with a Ni-
186 filter (35 kV, 40 mA). Scanning was performed between 3° and 70° 2 θ , with a step of 0.04° and a
187 count time of 2 s/step. The openings of the divergence, reception, and dispersion slots were 1, 0.2
188 and 1° respectively, and no monochromator was used. The identification of the mineral phases in
189 the material was performed using the X'Pert High Score program. The standard procedures
190 described in the literature and described by Moore and Reynolds³⁴ were followed for the
191 identification and quantification of the minerals. Quantification was based on the work of Biscaye³⁵.

192 2.6 Ultrasonic wave measurement

193 The equipment used was a portable EPOCH TX ultrasonic with P and S ultrasonic waves
194 measurements. Two transducers were placed on the top and bottom surfaces with a thin layer of
195 gel to ensure full contact between the specimen surfaces and the transducers. The time it takes for
196 the P and S elastic wave signals to travel through the sample was measured and divided by the
197 length of the sample. The shear and bulk moduli are then calculated by:

$$198 \quad G = \rho V_s^2 \text{ and } K = \rho \left(V_p^2 - \frac{4}{3} V_s^2 \right) \quad (9)$$

199 While the Young's Modulus and Poisson coefficient are calculated by:

$$200 \quad E = \frac{9KG}{3K+G} \text{ and } \nu = \frac{3K-2G}{6K+2G} \quad (10)$$

201 2.7 Mechanical testing

202 The uniaxial compression tests were performed on a 100 kN universal testing machine by imposing
203 a velocity rate of 0.5 mm/min. The carbonated and non-carbonated mixtures were tested. The
204 average strength value was calculated from 3 tested cylindrical samples of 38 mm in diameter by
205 76 mm height. Maximum compression strength and Young's modulus were obtained for all samples.

206 **3. Chemo-mechanical analysis of carbonated samples**

207 The experimental study has been complemented with the analysis of the chemo-poro-mechanical
208 coupled behavior of the cement with added 0.05% BNC and reacting with the CO₂. The model
209 simulates the carbonation front advance in cement subjected to scCO₂ and the changes generated
210 by the chemical reactions by using the classic balance equations of continuum mechanics relative

211 to mass, momentum, entropy, and energy^{36,37}. It is assumed that the porous solid remains saturated
 212 by the fluid (i.e. scCO₂ does not penetrate within the pores of the cement)^{38,39}. CO₂ is present in the
 213 skeleton as a dissolved species within the fluid.

214 When cement is carbonated, porosity undergoes several variations. Some are due to chemical
 215 reactions, denoted ϕ_L for leaching of cement matrix and ϕ_P for calcite precipitation. The other
 216 variations of porosity are due to the deformation of the porous medium, with φ_F and φ_C as the
 217 deformation of the porosity filled by fluid phase and by calcite phase, respectively. The porosities
 218 involved can be written as follows:

$$219 \quad \phi_F = \phi_0 + \phi_L - \phi_P + \varphi_F \quad (11)$$

$$220 \quad \delta_C = \phi_P + \varphi_C \quad (12)$$

221 Where ϕ_F corresponds to the pore volume occupied by the in-pore fluid per unit of initial volume of
 222 the porous medium, ϕ_0 corresponds to the initial pore space per unit of initial volume of porous
 223 medium which is not occupied by the solid phase. The difference between these two porosities is
 224 denoted by δ_C , which is the pore volume occupied by carbonate crystals³⁶.

225 The constitutive equations of isotropic linear poroelastic material of an infinitesimal representative
 226 volume element of a porous medium ($d\Omega_0$) are derived from Gibbs-Duhem equalities and Clausius-
 227 Duhem inequality assuming isothermal conditions:

$$228 \quad \boldsymbol{\sigma} - \boldsymbol{\sigma}_0 = \left(K - \frac{2}{3} G \right) (\boldsymbol{\varepsilon} - \boldsymbol{\varepsilon}_0) \mathbf{1} + 2G(\boldsymbol{\varepsilon} - \boldsymbol{\varepsilon}_0) - \sum_{k=F,C} b_k (p_k - p_{k,0}) \mathbf{1} \quad (13)$$

$$229 \quad \varphi_J - \varphi_{J,0} = b_J (\boldsymbol{\varepsilon} - \boldsymbol{\varepsilon}_0) + \sum_{k=F,C} \frac{p_k - p_{k,0}}{N_{JK}}; J = F, C \quad (14)$$

230 where $\boldsymbol{\sigma}$ and $\boldsymbol{\varepsilon}$ are the stress tensor and infinitesimal strain tensor, $\boldsymbol{\varepsilon} = \text{tr}(\boldsymbol{\varepsilon})$ is the volumetric strain,
 231 K and G are the bulk modulus and shear modulus in drained conditions, respectively. φ_J is the
 232 deformation of the porous volume occupied by the phase J (F stands for fluid and C for carbonates),
 233 while b_J and N_{JK} are the generalized Biot coefficients and the generalized poroelastic coupling
 234 moduli⁴⁰.

235 The coupling with the chemical reactions taking place during carbonation is established from the
 236 mass conservation law of the fluid and CO₂. Equation 15 is the fluid mass conservation, while
 237 Equation 16 is the conservation of the molar amount of CO₂:

$$238 \quad \left(\frac{\rho_f \phi_f}{K_f} + \frac{\rho_f}{N_{FF}} \right) \frac{\partial p_f}{\partial t} + \rho_f b \text{div} \left(\frac{\partial \mathbf{u}}{\partial t} \right) + \rho_f \sum_{R_i} Y_{R_i} \frac{\partial \xi_{R_i}}{\partial t} - \text{div} \left(\rho_f \frac{\kappa}{\eta} \text{grad} \rho_f \right) = 0 \quad (15)$$

$$239 \quad \frac{\partial(\phi_f c_{CO_2})}{\partial t} + \sum_{Ri} a_{Ri} \frac{\partial \xi_{Ri}}{\partial t} - \text{div} \left(d_{eff} \mathbf{grad} c_{CO_2} + c_{CO_2} \frac{\kappa}{\eta} \mathbf{grad} \rho_f \right) = 0 \quad (16)$$

240 where ρ_f, ϕ_f, K_f, p_f are the density, porosity, bulk modulus, and pressure of the fluid. a_{Ri} is the
 241 stoichiometric coefficient of the reaction Ri, c_{CO_2} is the CO₂ concentration in fluid, η is the dynamic
 242 viscosity of the fluid phase, Y_{Ri} is a variable that depends on the molar volumes of reactive species,
 243 \mathbf{u} is the skeleton displacement vector, ξ_{Ri} is the reaction advance depending on κ and d_{eff} , which
 244 are the permeability and diffusion coefficients.

245 The progress of carbonation is governed by the parameters of CO₂ diffusion in the fluid and by
 246 advection:

$$247 \quad \frac{\partial \xi_{Ri}}{\partial t} = \text{div} \left(d_{eff} \mathbf{grad} \frac{n_{CO_2}}{\phi_f} + n_{CO_2} \frac{\kappa}{\eta} \mathbf{grad} \rho_f \right) \quad (17)$$

248 where n_{CO_2} corresponds to the apparent CO₂ concentration. It should be noted that C-S-H
 249 carbonation does not start until the portlandite is completely carbonated, since Portlandite maintains
 250 a high pH level (pH > 12).

251 Since cement is a heterogeneous multiphase material, a homogenization technique was used to
 252 replace the heterogeneous media with a homogeneous media that behaves in the same manner⁴¹.

253 A modification in the homogenization formulation has been introduced to account for the contribution
 254 of bacterial nanocellulose (BNC) characteristics to the overall characteristics of modified Portland
 255 class G cement. The model is implemented in the finite element code BIL 2.3.0⁴².

256 Chemical reactions (carbonation-dissolution) occurring in the system induce changes in the
 257 transport and mechanical properties of the system. The main parameters that influence the
 258 carbonation advance are the intrinsic permeability κ and the diffusion coefficient d_{eff} . Advection
 259 behavior is subjected to the medium permeability and fluid flux, while diffusion is ruled by Fick's Law.
 260 Both phenomena are in turn intimately linked to the initial cement porosity^{43,44}. For this type of
 261 cement, it can be evaluated using:

$$262 \quad \kappa = \kappa_0 \left(\frac{\phi_F}{0.26} \right)^{11} 10^{-19} \text{ m}^2 \quad (18)$$

263 where κ_0 is a parameter to calibrate.

264 The variation of the porosity must be taken into account in the expression of the effective diffusion
 265 coefficient considering a porous medium. The effective diffusion coefficient is ϕD , while D is the

266 diffusion coefficient of the solute in the interstitial pore solution. Based on experimental data,
267 Mainguy and Coussy⁴⁵ propose the following expression for the effective coefficient of diffusion:

$$268 \quad d_{\text{eff}} = d_{\text{eff},0} e^{(9.95\phi_F - 29.08)} \quad (19)$$

269 Being $d_{\text{eff},0}$ a parameter to calibrate.

270 These equations are empirical and aimed at reasonably representing the transport phenomena
271 occurring within the cement matrix. Parameters κ_0 and $d_{\text{eff},0}$ can be modified to obtain values of
272 intrinsic permeability and diffusivity suitable for class G or H cement.

273 **4. Experimental results and discussion**

274 **Fig. 2** shows the longitudinal cut of samples after 30 days of carbonation. Brown color represents
275 the most degraded part of cement due to carbonation, the color probably being due to iron hydroxide
276 released from chemical reactions⁶. PC samples show a more intact core compared to BNC05.

277 The penetration depth had important progress on the cement cured at 90 °C after 30 days of
278 carbonation. These results are similar to values obtained by other authors for curing and carbonating
279 under similar conditions^{26,46}. There are some uncertainties based on studies by previous authors,
280 mainly from the curing conditions before carbonation. Indeed, water to cement ratio, curing
281 temperature, pressure, and duration will change the carbonation results, so different curing
282 conditions and equal carbonation procedures will yield different results. Some previous experiences
283 have short curing times for the cement^{26,46}, and show high CO₂ penetration, while some other
284 authors performed longer curing periods^{47,48}, showing less penetration. Recent works have shown
285 that cement with lower density allows a higher CO₂ penetration⁴⁹. Furthermore, a higher hydration
286 degree is tied with density increase, and porosity reduction⁵⁰, thus maintaining a high temperature
287 during a short curing period will allow deeper CO₂ penetration into the cement samples and more
288 advanced chemical reactions.

289 In this work, carbonation led to an increase in the density of PC and BNC05 samples. Before
290 carbonation, a slight difference is noted between PC and BNC05 samples, with densities of 1.89
291 and 1.87 g/cm³, respectively. Once the samples were carbonated, density increased until 2.13 and
292 2.11 g/cm³ for PC and BNC05 (**Table 2**). PC shows an average mass uptake of 13.2% while BNC05
293 shows an average of 12.9%, meaning that fewer chemical reactions have taken place. The mass
294 gain is similar to previous works under similar conditions⁴⁶, however, the penetration depth is
295 different. Our results are closer to the penetrations observed by Fabbri and co-workers²⁶, even

296 though our samples are not fully carbonated after 30 days. This is because our samples are larger,
297 therefore more chemical CO₂-bonds are needed to carbonate more volume and chemical reactions
298 are limited by diffusion of CO₂.

299 The oven-drying conditioning for one week at 85 °C has not significantly affected the MIP porosity
300 or the pore size distribution from non-conditioned samples (**Fig. 3**). MIP porosity performed on these
301 samples increased for both cement types from 33.7% to 34.5%, prior to the carbonation test, and
302 the characteristic peak is approximately 50 nm. Samples with bacterial nanocellulose did not
303 significantly modify the cement in terms of porosity or pore size distribution compared to PC cement
304 cured at 90 °C. It is likely that bacterial nanocellulose is not having the same effect in inhibiting the
305 larger cracks produced by the high curing temperature.

306 Calorimetry tests have shown that BNC initially acts as a cement retarder^{51,52}. As the curing time in
307 this work is short, the porosity of BNC-cement is similar to PC with some coarser pores at 0.2 μm.
308 Nevertheless, for longer curing periods, for instance, cement cured at 20 °C for 28 days, cement
309 structure is denser and more compact, so in these conditions, bacterial nanocellulose is more likely
310 to develop a fiber network inside the cement and to increment hydration degree^{53,54}, as it tends to
311 release adsorbed water which contributes hydration¹⁸.

312 The MIP results after the carbonation of PC are presented in **Fig. 4**. Here we can observe that the
313 porosity variation along the radial direction leads to smaller pores and to smaller porosity values,
314 while the characteristic peak is shifted to pores smaller than 10 nm. After carbonation, no major
315 change is observed due to the addition of BNC. Porosity decreased to 24.5% at the core and to
316 21.5% near the exposed surface. BNC05 shows similar results to PC (**Fig. 5**), and its porosity
317 decreased at the core to 23.2% and near the exposed surface to 21%. The slight mass uptake is
318 due to the consumption of CO₂ by the occurring chemical reactions and is reflected by these small
319 porosity variations. Reduced porosities lead to less diffusion of CO₂ into the cement core and
320 therefore increase the time to reach full carbonation of the samples.

321 The permeability results in **Table 3** are consistent with the intrinsic permeability values of cement
322 cured at a high temperature. This method simplifies the complexity of crosslinking between different
323 cylinders of different pore diameters and considers a tortuosity of 1⁵⁵. The Li values are very high
324 for small diameter pores, so a higher deviation error is also induced.

325 In this analysis, cement with nanocellulose addition appears to have lower permeability than cement
326 without additions. After carbonation, the permeability values of PC are reduced by one order of
327 magnitude, while the permeability in cement with BNC addition is in the same order of magnitude
328 as the initial value. Experiments on carbonate cement samples are necessary to validate these
329 results.

330 Fig. 6 presents the XRD patterns of the samples before and after carbonation. The relative
331 percentages of the crystalline phases are presented in **Table 4**. The analyses show the contents of
332 portlandite, katoite, brownmillerite, magnesite, aragonite, and calcite.

333 Portlandite is one of the main cement hydration products with high crystallinity, while C-S-H is a low
334 crystallinity amorphous material. Brownmillerite is a phase of Clinker denominated as C_4AF .
335 Aragonite and calcite are calcium carbonates of a different crystalline system with Orthorhombic and
336 Rhombohedral shapes, respectively. When the study temperature is high, new crystalline phases
337 such as katoite appear. Katoite is a calcium aluminate hydrate more stable at high temperatures
338 than ettringite.

339 The results of **Table 4** in cement without supercritical carbonation indicate approximately 60%
340 hydrated material (portlandite and katoite), 25% carbonated material (calcite and magnesite), and
341 15% non-hydrated and non-carbonated material (brownmillerite). It can be determined that during the
342 curing process prior to supercritical carbonation, 25% of crystalline material is already carbonated.
343 The lack of crystals related to C-S-H is due to the insufficient intensity of reflection of this amorphous
344 material ⁵⁶. It is possible that the short curing time has generated a low reflection tobermorite and
345 that the small readings have been incorporated into the crystalline phase of the katoite or calcite.

346 After supercritical carbonation, the most affected materials were portlandite and katoite as the XRD
347 shows no cement hydration materials, indicating complete carbonation. Magnesite also seems to
348 have been consumed, allowing more calcium carbonates to be created. Approximately 93% are
349 carbonate crystalline materials, the remaining 7% is C_4AF from the clinker phase that did not
350 chemically react.

351 The results of the PC and BNC05 samples before and after carbonation are similar to each other,
352 suggesting that the BNC did not have a significant effect on the microcrystalline structure of the
353 cement under these curing conditions.

354 **Table 5** shows the mechanical properties measured by V_S and V_P . Overall, during the carbonation
355 process, mechanical properties increase. This is corroborated by UCS tests. The samples show an
356 increment in compressive strength and also in their Young's modulus (**Fig. 7**). PC strength initially
357 was 31 MPa and after the carbonation stage, it increased by 44%, while BNC05 started with 24 MPa
358 of strength, which increased by 60% with carbonation. Both types of cement initially had Young's
359 modulus of 20 GPa, unlike the 25 GPa in long-cured specimens²⁴, but after carbonation, this
360 modulus increased by 11% for PC and by 18% for BNC05.

361 Nanocellulose has been reported to improve the mechanical properties of cement composites for
362 well-hydrated cement^{19,57,58}. In the present work, BNC05 samples initially have compressive strength
363 lower than PC samples and comparable Young moduli. These observations distinguish from the
364 results previously obtained with cement cured at room temperature over a long period²². Curing at
365 a higher temperature is probably generating larger cracks in the cement, so the microstructural effect
366 of BNC does not substantially improve the mechanical behavior. Or this effect appears later because
367 of the retarder effect of BNC or the superplasticizer, which slow down the hydration rate of the
368 modified cement, and thus the hydration degree at the end of the curing time.

369 It is well known that carbonation under atmospheric conditions tends to increase the mechanical
370 properties of cement^{59,60}. However, there is no agreement on cement strength variations after
371 supercritical carbonation⁴⁶. In supercritical conditions, some results show an increment in
372 compressive strength^{61,62}, while more recent researchers were able to see a decrease in mechanical
373 performance^{26,63,64}. This variation is due to different conditions of cement hydration prior to
374 carbonation⁶⁵ and subsequent carbonation conditions⁶². Indeed, experiments using the same
375 cement and water to cement ratio and same carbonation conditions show a drop in strength values²⁴.
376 After short curing conditions, during carbonation, cement will not be fully hydrated, and the
377 mechanical performance increment after carbonation will be most likely due to the cement matrix
378 development by hydration acceleration imposed by temperature in the carbonation cell. The
379 mechanical properties of the tested material will be a combination of the effects of cement hydration
380 compounds and precipitated calcite that has been produced during carbonation. On the other hand,
381 well-hydrated cement will only experience a drop in strength due to C-S-H degradation and porosity
382 increase over time^{24,48,64,66}. In this work, supercritical carbonation is positively affecting the
383 mechanical performance of cement. These observations are intricately linked to the carbonations

384 conditions. Indeed, if cement carbonation is imposed by a continuously renewed fluid flushing, then
385 the products of carbonation (mainly carbonates), will in turn dissolve and be flushed out, leading to
386 a strong increase in porosity of the cement, and degraded mechanical properties. In the present
387 experiment, CO₂ penetrates the sample by dissolution and diffusion in the pore fluid, which is not
388 renewed.

389 Since CC has better mechanical performance than CH, CC precipitation should increase mechanical
390 performance and Young's modulus. This effect can take place here because of the continuous
391 hydration of cement inside the reactor, which is linking the precipitated CC with the cement matrix.
392 These two effects are increasing mechanical properties as seen by Fabbri et al. and Sauki et al.^{26,62},
393 but cement hydration plays the most significant role during the carbonation process. This can also
394 be observed from V_P and V_S wave data, where mechanical parameters increased. However, Young's
395 moduli differ from the ones measured by UCS tests. Young's moduli measured by elastic waves are
396 19.5 and 21.3 GPa for PC before and after carbonation, while for BNC05, it measured 18 and 20,5
397 GPa. The real values obtained from UCS tests showed 20 GPa for both cement before carbonation,
398 while after carbonation, it showed 22.2 GPa and 23.6 GPa for PC and BNC05, respectively.

399 After carbonation, **Fig. 7** shows that the increase in the relative strength and Young modulus of
400 BNC05 is greater compared to PC. This is linked with cement hydration during carbonation, where
401 the hydration kinetics have been enhanced in BNC-samples by the hydrophilic properties of the
402 bacterial nanocellulose⁵⁴ and its ability to release water during hydration¹⁸.

403 **5. Numerical analysis of carbonated samples**

404 In this section, the numerical analysis of the carbonated BNC samples is presented. A 2D analysis
405 is performed simulating the experimental carbonation of the cylindrical samples. Calibration on the
406 model is made by taking the porosity values obtained experimentally to estimate the intrinsic
407 parameters of this cement. The initial volumetric proportions of the minerals in the cement are
408 estimated from the literature. The calibrated model is extrapolated to simulate in 1D the cement
409 carbonation in a wellbore system under downhole conditions.

410 **5.1 Initial parameters and intrinsic properties of cement**

411 Porosity is very variable for cement and depends mainly on the water to cement ratio and on the
412 type of curing in which the specimen is placed. Some authors estimate porosities greater than
413 30%^{28,46,67,68}, while others approximate it from 20% to 30%^{69–72}. Regardless of the kind of oil cement

414 in question (G or H), it can be generalized that the porosities of oil cement are around 25% to 35%.
415 The initial porosity of the samples in this work before carbonation is 34.5% as indicated in Section
416 4.

417 The volumetric content of cement minerals depends substantially on the cement type, water to
418 cement ratio, hydration degree, and curing temperature. So, it is necessary to estimate these
419 proportions for the simulation. In some articles, the amount of Portlandite CH varies between 15 to
420 25%^{43,70}, with commonly accepted values being percentages of 18 to 20%³⁶. In previous results,
421 using the same cement and same water to cement ratio²², a percentage of 20% was obtained by
422 thermogravimetric analysis on well-hydrated cement samples. Class G and H cement have very low
423 initial aluminate contents following API requirements aiming at being resistant to sulfate attacks
424 ($C_3A \leq 3\%$ and $C_4AF + 2 C_3A \leq 24\%$). So the hydrated aluminate components have a low
425 percentage, around 6 to 14%^{36,69,73}. Finally, the most important phase of cement in terms of
426 compressive strength, C-S-H, can vary between 60 to 27% in volume fraction^{36,73}.

427 The intrinsic permeability is independent of the conditions to which the material is initially subjected,
428 at least directly. Since cement is a heterogeneous material, there is no unique intrinsic permeability
429 value for cement. Nelson et al.⁶¹ in their experiments report values of $1 \times 10^{-16} \text{ m}^2$ to $1 \times 10^{-20} \text{ m}^2$. This
430 is supported by Ghabezloo et al.⁷⁰ and Mainguy et al.⁷⁴, who obtain values in the order of $1 \times 10^{-19} \text{ m}^2$
431 y $1 \times 10^{-20} \text{ m}^2$. Sercombe et al.⁷² show values of $1 \times 10^{-16} \text{ m}^2$ after excessive heating on hardened
432 cement paste, so it can be assumed that this order of magnitude refers to cracked cement.

433 The diffusivity of cement for class G and H has also been variable, as reported by different authors.
434 Huet et al.⁷⁵ performs a compilation of the different transport mechanisms of cement G subjected to
435 an environment of scCO_2 and quotes diffusivity values of $1 \times 10^{-12} \text{ m}^2\text{s}^{-1}$ down to $1 \times 10^{-14} \text{ m}^2\text{s}^{-1}$.
436 Mainguy et al.⁷⁴ give an example of diffusion in the order of $1 \times 10^{-12} \text{ m}^2\text{s}^{-1}$, and Vallin et al.³⁶ determine
437 a value of $1 \times 10^{-10} \text{ m}^2\text{s}^{-1}$ on the simulation. Furthermore, Shen⁷⁶ quotes the values of different
438 aqueous species in the order of $1 \times 10^{-9} \text{ m}^2\text{s}^{-1}$.

439 To obtain the diffusion and permeability parameters for this particular cement for later use in the
440 simulation at reservoir level, a porosity value equal to the experimental value of 34.5% for the first
441 simulation is considered. As the rest of the volumetric proportions are variable, values were adopted
442 from literature considering a 0.05% content of BNC: C-S-H 40.5%, CH 18%, aluminates 6.942%,
443 and BNC 0.058%. The remaining compounds are classified as inert components, including

444 amorphous silica which is a carbonation product. CO₂ concentration is calculated considering: water
445 volume, temperature, pressures, and mole fraction of CO₂ from experiments. The calculations give
446 values of 1200 mol/m³.

447 The initial parameters for fluid and cement are listed in **Table 6**, where η_{vis} is the fluid viscosity, K_F
448 the fluid compressibility, ρ_F is the fluid density, R_c is cement compressive strength, and R_t the
449 tensile strength. **Table 7** shows the molar volumes of the compounds involved.

450 The 2D model for the experimental carbonation consists of one-quarter of a sample (19 mm-radius
451 by 38 mm-height) using a mesh of 22x11 elements (**Fig. 8**). The lower horizontal contour has
452 restricted movements in the X direction, while the left vertical contour has restricted movements in
453 the Y direction. The top and right-hand contours are subjected to the carbonation conditions. **Table**
454 **8** shows the initial conditions for modeling.

455 The well-system modeled consists of a CO₂ reservoir drilled and refilled with a steel casing protected
456 by an annular cement geometry. We used the same transport values after determining the advection
457 and diffusion parameters from the previous simulation. The model for the wellbore simulation
458 assumes 1D axial symmetry under plane strain conditions in the axial direction. The mesh of $\frac{3}{4}$ of
459 an inch (19 mm) represents the annular cement thickness and allows studying the progress of
460 carbonation from the outer surface towards the inner cement. It consists of 502 elements that have
461 the properties of the modified cement with BNC. Previous conditions for temperature and fluid
462 pressure are considered (that is 90 °C and 20 MPa) with a 1.2 CO₂ molarity.

463 5.2 Results and discussion

464 First, a sensitivity analysis of parameters to calibrate the numerical model is made to reproduce the
465 experimental penetration results. **Table 9** and **Table 10** show the values of the intrinsic permeability
466 and diffusion coefficient varying κ_0 and $d_{eff,0}$. As it can be observed, the values of permeability and
467 diffusivity are in the range of the admissible values for cement class G previously mentioned.

468 By calibrating the model for $\kappa_0=350$ and $d_{eff,0}=160$, a representation of the entire sample consistent
469 with the MIP experimental results of porosity can be observed in **Fig. 9**. Results clearly show how
470 the carbonation advanced into the core. The 1D image shows the porosity variation as a function of
471 the radius. The material near the exposed surface is completely carbonated, and the porosity
472 reaches 21%, while at the core, the porosity average is similar to the 23,2% from the MIP
473 experiments.

474 **Fig. 10** shows in more detail the dissolution and carbonation fronts. The blue line corresponds to
475 the starting point of the chemical reaction of CH, while the red line is the limit between the
476 carbonation process and where the hydrated products have already been carbonated. Some authors
477 consider that the carbonation front or penetration depth follows a linear trend as a function of the
478 square root of time (consistently with the fact that the chemical reactions are limited by the diffusion
479 of CO₂ within the fluid phase)^{77,78}. Nevertheless, this is usually based on the phenolphthalein test
480 which only considers the pH below 9. With the present model, we can distinguish the two fronts. In
481 a first contact between the cement and scCO₂, there is a significant decrease in CH and C-S-H
482 content that lasts for the first few days. After 10 days, the dissolution front reaches the center of the
483 cement sample. The complete reaction of CH and C-S-H front advances almost linearly in time but,
484 it does not reach the cement center. Calcite is mostly deposited in the material near the exposed
485 surface, decreasing its porosity, while in the core, it has not yet completely precipitated.

486 Even though the dissolution front has reached the center, the chemical reactions between CO₂ and
487 CH/C-S-H, which produce CC and water are still taking place in a region located 1 cm away from
488 the center, meaning that all CH and C-S-H have not yet been completely leached after 30 days in
489 these conditions.

490 The calibrated parameters are extrapolated to the cement submitted under downhole conditions in
491 the context of CO₂ geological storage. We have to keep in mind that in the experimental results,
492 curing and carbonation conditions are unfavorable to cement. However, the numerical can be
493 adapted to any condition considered. From this approach, additional characteristics of the variability
494 of the carbonation front using these transport parameters can be obtained: permeability (**Fig. 11**)
495 and volumetric proportions (**Fig. 12**) variations throughout the sample. Carbonation advance forms
496 calcite from CH and C-S-H, which grows inside the pores, this produces a reduction of the porosity
497 and, as a consequence, a decrease in permeability and diffusivity, that slow down the entry of more
498 CO₂ to the cement core. In **Fig. 11**, this can be seen as a clogging effect. After 5 days of carbonation,
499 we can observe a considerable CO₂ penetration, but after 5 more days, the penetration rate has
500 significantly slowed down. The penetration of calcite in **Fig. 12** starts with the CH area dissolution
501 and continues with the C-S-H decalcification when there is no longer CH to consume. C-S-H
502 decalcification continues creating CC and amorphous silica, which becomes part of the inert
503 components.

504 **6. Conclusion**

505 The microstructure and mechanical changes of cement paste with bacterial nanocellulose additions
506 and cured at 90 °C in the context of reservoir conditions were analyzed. Mercury intrusion
507 porosimetry (MIP), X-ray diffraction (XRD), ultrasonic wave measurements, and unconfined
508 compressive strength (UCS) tests were performed on BNC-cement samples subjected to
509 supercritical CO₂ conditions to determine its behavior. In addition, a finite-element based numerical
510 analysis of the cement-rock interface was presented.

511 BNC samples show a lower mass gain compared to PC, suggesting that fewer chemical reactions
512 occurred. Nevertheless, the longitudinal sections of the BNC-cement present some small voids in
513 their interior, which could allow further CO₂ penetration.

514 The MIP results show that initially, the samples with BNC have the same porosity as the cement
515 without BNC addition. After carbonation, lower porosity is observed in cement with BNC, either in
516 the core or near the exposed surface. From the MIP curves, a permeability analysis was performed.
517 In this analysis, the samples with BNC show lower intrinsic permeability values than the cement
518 without BNC.

519 The XRD results of the PC and BNC05 samples before and after carbonation show no difference
520 from each other. After carbonation, the dominant crystalline phases are calcite and aragonite, which
521 indicates the complete carbonation of the material.

522 Unmodified samples show a better mechanical performance during carbonation. However,
523 carbonation in samples with BNC indicates a higher increase in relative strength than in samples
524 without additions due to the BNC effect of releasing water during hydration inside the carbonation
525 cell.

526 A chemo-poro-mechanical model of scCO₂ attack on a cement annulus of an abandoned oil well in
527 the context of CO₂ storage was presented. A modification on the formulation was implemented to
528 add the nanocellulose characteristics. The experimental data and simulation results were back
529 analyzed to determine the properties of the cement used. Once these properties were known, a
530 simulation under downhole conditions in the context of CO₂ geological storage was represented.

531 Results show a decrease in permeability and hydration products over time and the advance of the
532 dissolution and carbonation fronts. The numerical study shows the advantage of the use of this type

533 of tool for the study of possible real scenarios of CO₂ injection processes in deep wells. It can be
534 adapted to different systems under different established conditions.

535 **Acknowledgments**

536 The first author gratefully acknowledges the fellowship granted by the National Scientific and
537 Technical Research Council of Argentina (CONICET) and to the EIFFEL fellowship program of
538 Excellence granted by the Ministère de l'Europe et des Affaires étrangères of France. The authors
539 acknowledged the financial support of the European Commission -H2020 MSCA-RISE 2020 Project
540 DISCO2-STORE, Grant Agreement N° 101007851-, the Universidad Nacional de la Patagonia San
541 Juan Bosco -Project UNPSJB PI1614 80020190200006 IP, Res. R/9N°207-2020 CRD1365 FI004/
542 17-, the Agency of Scientific and Technological Promotion from the Argentine Republic. (Projects
543 PICT 2016–4543, PICT 0843 2016), and the Institutional project ITPN PUE 0034 (CONICET). The
544 authors also thank Dr. Siavash Ghabezloo and Dr. Teresa Piqué for helpful discussions, and also
545 the technical staff of Petroquímica Comodoro Rivadavia and Laboratoire Navier for helping with the
546 tests performed.

547 **Nomenclature**

548	γ :	<i>Mercury surface tension</i>
549	δ_C :	<i>Pore volume occupied by carbonate crystals</i>
550	ΔP_i :	<i>Mercury pressure step</i>
551	ΔP_t :	<i>Total pressure increase in meters' water column measured in the MIP</i>
552	$\boldsymbol{\varepsilon}$:	<i>Infinitesimal strain tensor</i>
553	ε :	<i>Volumetric strain. ($\text{tr}(\boldsymbol{\varepsilon})$)</i>
554	η :	<i>Dynamic viscosity of the fluid phase</i>
555	θ :	<i>Mercury contact angle</i>
556	κ :	<i>Intrinsic permeability</i>
557	ν :	<i>Poisson's ratio</i>
558	ξ_{Ri} :	<i>Reaction advance</i>
559	ρ :	<i>Bulk density of the specimen</i>
560	ρ_f :	<i>Fluid density</i>
561	$\boldsymbol{\sigma}$:	<i>Stress tensor</i>
562	φ_C :	<i>Deformation of the porous medium filled by calcite phase</i>
563	φ_F :	<i>Deformation of the porous medium filled by fluid phase</i>
564	φ_J :	<i>Deformation of the porous volume occupied by the phase J</i>
565	ϕ_0 :	<i>Pore space per unit of initial volume of porous medium not occupied by the solid phase</i>
566	ϕ_f :	<i>Fluid porosity</i>

567	ϕ_F :	<i>Pore volume occupied by the in-pore fluid per unit volume of porous medium</i>
568	ϕ_L :	<i>Porosity due to leaching of cement matrix</i>
569	ϕ_P :	<i>Porosity due to of calcite precipitation</i>
570	a_{Ri} :	<i>Stoichiometric coefficient of the reaction Ri</i>
571	b_j :	<i>Generalized Biot coefficient</i>
572	c_{CO_2} :	<i>Is the CO₂ concentration in fluid</i>
573	d_i :	<i>Pore diameter</i>
574	d_{eff} :	<i>Diffusion coefficient</i>
575	i :	<i>Hydraulic gradient</i>
576	L_i :	<i>Cylinder length of diameter i</i>
577	L_e :	<i>Average pore length</i>
578	n :	<i>Total number of pores of different diameters</i>
579	n_{CO_2} :	<i>Apparent CO₂ concentration</i>
580	ρ :	<i>Mercury pressure</i>
581	p_f :	<i>Fluid pressure</i>
582	\mathbf{u} :	<i>Skeleton displacement vector</i>
583	E :	<i>Young's Modulus</i>
584	G :	<i>Shear Modulus</i>
585	K :	<i>Bulk modulus</i>
586	K_f :	<i>Fluid bulk modulus</i>
587	N_{JK} :	<i>Generalized poroelastic coupling moduli</i>
588	S :	<i>cross-section of a cubic specimen with sides of length L_e</i>
589	V_i :	<i>Volume of mercury intrusion into the pore of diameter i</i>
590	V_s :	<i>Elastic S-wave velocity</i>
591	V_t :	<i>Total apparent volume of the MIP sample</i>
592	V_p :	<i>Elastic P-wave velocity</i>
593	Y_{Ri} :	<i>Variable that depends of the molar volumes of reactive species</i>

594

595 **References**

- 596 1. Afroz R, Hassan MN, Ibrahim NA. Review of air pollution and health impacts
597 in Malaysia. *Environ Res.* 2003;92(2):71-77. doi:10.1016/S0013-
598 9351(02)00059-2
- 599 2. Philip Ringrose. *How to Store CO₂ Underground: Insights from Early-Mover*
600 *CCS Projects.* Springer; 2020.

- 601 3. Michael K, Golab A, Shulakova V, et al. Geological storage of CO₂ in
602 saline aquifers — A review of the experience from existing storage
603 operations. *Int J Greenh Gas Control*. 2010;4(4):659-667.
604 doi:10.1016/j.ijggc.2009.12.011
- 605 4. Bachu S, Bonijoly D, Bradshaw J, et al. CO₂ storage capacity estimation:
606 Methodology and gaps. *Int J Greenh Gas Control*. 2007;1(4):430-443.
607 doi:10.1016/S1750-5836(07)00086-2
- 608 5. Civile D, Zecchin M, Forlin E, et al. CO₂ geological storage in the Italian
609 carbonate successions. *Int J Greenh Gas Control*. 2013;19:101-116.
610 doi:10.1016/j.ijggc.2013.08.010
- 611 6. Carey JW, Wigand M, Chipera SJ, et al. Analysis and performance of oil
612 well cement with 30 years of CO₂ exposure from the SACROC Unit, West
613 Texas, USA. *Int J Greenh Gas Control*. 2007;1(1):75-85.
614 doi:10.1016/S1750-5836(06)00004-1
- 615 7. Vilarrasa V, Laloui L. Potential fracture propagation into the caprock
616 induced by cold CO₂ injection in normal faulting stress regimes. *Geomech
617 Energy Environ*. 2015;2:22-31. doi:10.1016/j.gete.2015.05.001
- 618 8. Urpi L, Rinaldi A, Rutqvist J, Cappa F, Spiers CJ. Dynamic simulation of
619 CO₂-injection-induced fault rupture with slip-rate dependent friction
620 coefficient. *Geomech Energy Environ*. 2016;7:47-65.
621 doi:10.1016/j.gete.2016.04.003
- 622 9. Mason HE, Frane WL Du, Walsh SDC, Dai Z, Charnvanichborikarn S,
623 Carroll SA. Chemical and Mechanical Properties of Wellbore Cement
624 Altered by CO₂ - Rich Brine Using a Multianalytical Approach. *Environ Sci*

- 625 *Technol.* 2013;47:1745-1752. doi:dx.doi.org/10.1021/es3039906
- 626 10. Fernández Bertos M, Simons SJR, Hills CD, Carey PJ. A review of
627 accelerated carbonation technology in the treatment of cement-based
628 materials and sequestration of CO₂. *J Hazard Mater.* 2004;112(3):193-205.
629 doi:10.1016/j.jhazmat.2004.04.019
- 630 11. Shah V, Scrivener K, Bhattacharjee B, Bishnoi S. Changes in microstructure
631 characteristics of cement paste on carbonation. *Cem Concr Res.*
632 2018;109(April):184-197. doi:10.1016/j.cemconres.2018.04.016
- 633 12. Matteo EN, Huet B, Jové-Colón CF, Scherer GW. Experimental and
634 modeling study of calcium carbonate precipitation and its effects on the
635 degradation of oil well cement during carbonated brine exposure. *Cem*
636 *Concr Res.* 2018;113(May 2017):1-12.
637 doi:10.1016/j.cemconres.2018.03.016
- 638 13. Kim S, Santamarina JC. Reactive fluid flow in CO₂ storage reservoirs: A 2-
639 D pore network. *Greenh Gases Sci Technol.* 2015;473(5):462-473.
640 doi:10.1002/ghg
- 641 14. Lesti M, Tiemeyer C, Plank J. CO₂ stability of Portland cement based well
642 cementing systems for use on carbon capture & storage (CCS) wells. *Cem*
643 *Concr Res.* 2013;45(1):45-54. doi:10.1016/j.cemconres.2012.12.001
- 644 15. Abid K, Gholami R, Choate P, Nagaratnam BH. A review on cement
645 degradation under CO₂-rich environment of sequestration projects. *J Nat*
646 *Gas Sci Eng.* 2015;27:1149-1157. doi:10.1016/j.jngse.2015.09.061
- 647 16. Teodoriu C, Bello O. A review of cement testing apparatus and methods
648 under CO₂ environment and their impact on well integrity prediction –

- 649 Where do we stand? *J Pet Sci Eng.* 2020;187:106736.
650 doi:10.1016/j.petrol.2019.106736
- 651 17. Sun X, Wu Q, Lee S, Qing Y, Wu Y. Cellulose Nanofibers as a Modifier for
652 Rheology, Curing and Mechanical Performance of Oil Well Cement. *Sci*
653 *Rep.* 2016;6:1-9. doi:10.1038/srep31654
- 654 18. Hisseine OA, Omran AF, Tagnit-Hamou A. Influence of cellulose filaments
655 on cement paste and concrete. *J Mater Civ Eng.* 2018;30(6):1-14.
656 doi:10.1061/(ASCE)MT.1943-5533.0002287
- 657 19. Hisseine OA, Wilson W, Sorelli L, Tolnai B, Tagnit-Hamou A. Nanocellulose
658 for improved concrete performance: A macro-to-micro investigation for
659 disclosing the effects of cellulose filaments on strength of cement systems.
660 *Constr Build Mater.* 2019;206:84-96. doi:10.1016/j.conbuildmat.2019.02.042
- 661 20. Cerrutti P, Roldán P, García RM, Galvagno MA, Vázquez A, Foresti ML.
662 Production of bacterial nanocellulose from wine industry residues:
663 Importance of fermentation time on pellicle characteristics. *J Appl Polym*
664 *Sci.* 2016;133(14). doi:10.1002/app.43109
- 665 21. Mejdoub R, Hammi H, Suñol JJ, Khitouni M, Boufi S. Nanofibrillated
666 cellulose as nanoreinforcement in Portland cement : Thermal , mechanical
667 and microstructural properties. *J Compos Mater.* 2017;51(17):2491-2503.
668 doi:10.1177/0021998316672090
- 669 22. Barría JC, Vazquez A, Pereira J, Manzanal D. Effect of bacterial
670 nanocellulose on the fresh and hardened states of oil well cement. *J Pet Sci*
671 *Eng.* 2021;In press. doi:10.1016/j.petrol.2020.108259
- 672 23. Hoyos CG, Zuluaga R, Gañán P, Pique TM, Vazquez A. Cellulose

- 673 nanofibrils extracted from fique fibers as bio-based cement additive. *J Clean*
674 *Prod.* 2019;235:1540-1548. doi:10.1016/j.jclepro.2019.06.292
- 675 24. Barría JC, Manzanal D, Pereira J-M, Ghabezloo S. Study on
676 poromechanical changes of nanocellulose cement composite subjected to
677 supercritical CO₂. 2020.
- 678 25. Liu X, Falcone G, Alimonti C. A systematic study of harnessing low-
679 temperature geothermal energy from oil and gas reservoirs. *Energy*.
680 2018;142:346-355. doi:10.1016/j.energy.2017.10.058
- 681 26. Fabbri A, Corvisier J, Schubnel A, et al. Effect of carbonation on the hydro-
682 mechanical properties of Portland cements. *Cem Concr Res.*
683 2009;39(12):1156-1163. doi:10.1016/j.cemconres.2009.07.028
- 684 27. Yurtdas I, Xie SY, Burlion N, Shao JF, Saint-Marc J, Garnier A. Influence of
685 chemical degradation on mechanical behavior of a petroleum cement paste.
686 *Cem Concr Res.* 2011;41(4):412-421.
687 doi:10.1016/j.cemconres.2011.01.008
- 688 28. Rimmelé G, Barlet-gouédard V, Porcherie O, Goffé B, Brunet F.
689 Heterogeneous porosity distribution in Portland cement exposed to CO₂ -
690 rich fluids. *Cem Concr Res.* 2008;38:1038-1048.
691 doi:10.1016/j.cemconres.2008.03.022
- 692 29. Samudio M. Modelling of an oil well cement paste from early age to
693 hardened state : hydration kinetics and poromechanical behaviour To cite
694 this version : 2018.
- 695 30. Charreau H, L. Foresti M, Vazquez A. Nanocellulose Patents Trends: A
696 Comprehensive Review on Patents on Cellulose Nanocrystals,

- 697 Microfibrillated and Bacterial Cellulose. *Recent Pat Nanotechnol.*
698 2012;7(1):56-80. doi:10.2174/18722105130106
- 699 31. API Specification 10A. *Specification for Cements and Materials for Well*
700 *Cementing*. Twenty-Fif. Northwest Washington, DC; 2019.
701 https://www.techstreet.com/standards/api-spec-10a?product_id=2038411.
- 702 32. Zeng Q, Li K, Fen-Chong T, Dangla P. Analysis of pore structure, contact
703 angle and pore entrapment of blended cement pastes from mercury
704 porosimetry data. *Cem Concr Compos.* 2012;34(9):1053-1060.
705 doi:10.1016/j.cemconcomp.2012.06.005
- 706 33. Khaddour F, Grégoire D, Pijaudier-Cabot G. A Hierarchical Model for the
707 Computation of Permeation Properties of Porous Materials and Their
708 Enhancement due to Microcracks. *J Eng Mech.* 2018;144(2):04017160.
709 doi:10.1061/(asce)em.1943-7889.0001392
- 710 34. Moore D, Reynolds R. *X-Ray Diffraction and the Identification and Analysis*
711 *of Clay Minerals.*; 1989.
- 712 35. Biscaye PE. Geological Society of America Bulletin Mineralogy and
713 Sedimentation of Recent Deep-Sea Clay in the Atlantic Ocean and Adjacent
714 Seas and Oceans. *Geol Soc Am Bulletin.* 1965;76(7):803-832.
715 doi:10.1130/0016-7606(1965)76
- 716 36. Vallin V, Pereira JM, Fabbri A, Wong H. Numerical modelling of the hydro-
717 chemo-mechanical behaviour of geomaterials in the context of CO₂
718 injection. 2013;(April):3052-3069. doi:10.1002/nag
- 719 37. Vallin V. Modélisation chimio poromécanique du comportement des
720 géomatériaux dans le contexte du stockage géologique du dioxyde de

- 721 carbone : Application au puits d'injection. 2014.
- 722 38. Manzanal D, Vallin V, Pereira JM. A chemo-poromechanical model for
723 well/caprock interface in presence of CO₂. *Poromechanics V - Proc 5th Biot*
724 *Conf Poromechanics*. 2013:1470-1477. doi:10.1061/9780784412992.175
- 725 39. Fabbri A, Jacquemet N, Seyedi DM. A chemo-poromechanical model of
726 oilwell cement carbonation under CO₂ geological storage conditions. *Cem*
727 *Concr Res*. 2012;42(1):8-19. doi:10.1016/j.cemconres.2011.07.002
- 728 40. Coussy O. *Mechanics and Physics of Porous Solids.*; 2010.
729 doi:10.1002/9780470710388
- 730 41. Ulm FJ, Constantinides G, Heukamp FH. Is concrete a poromechanics
731 material? - A multiscale investigation of poroelastic properties. *Mater Struct*
732 *Constr*. 2004;37(265):43-58. doi:10.1617/14100
- 733 42. Dangla P, Bonnard A. Ifsttar/bil: first version in github (Version v2.4).
734 Zenodo. 2017. doi:10.5281/zenodo.1039729
- 735 43. Mainguy M. modeles de diffusion non-lineaires en milieux poreux.
736 Applications a la dissolution et au sechage des materiaux cimentaires.
737 1999.
- 738 44. Ghabezloo S. Comportement thermo-poro-mécanique d'un ciment pétrolier.
739 2008:204.
- 740 45. Mainguy M, Coussy O. Propagation Fronts during Calcium Leaching and
741 Chloride Penetration. *J Eng Mech*. 2000;126(3):250-257.
742 doi:10.1061/(asce)0733-9399(2000)126:3(250)
- 743 46. Barlet-Gouedard V, Rimmelé G, Goffé B, Porcherie O. Well Technologies

- 744 for CO₂ Geological Storage : CO₂ -Resistant Cement. *SPE Int.*
745 2007;62(3):325-334. doi:10.2516/ogst
- 746 47. Kutchko BG, Strazisar BR, Dzombak DA, Lowry G V., Thaurow N.
747 Degradation of well cement by CO₂ under geologic sequestration
748 conditions. *Environ Sci Technol.* 2007;41(13):4787-4792.
749 doi:10.1021/es062828c
- 750 48. Gu T, Guo X, Li Z, et al. Coupled effect of CO₂ attack and tensile stress on
751 well cement under CO₂ storage conditions. *Constr Build Mater.*
752 2017;130:92-102. doi:10.1016/j.conbuildmat.2016.10.117
- 753 49. Costa BL d. S, Freitas JC d. O, Melo DM d. A, Araujo RG d. S, Oliveira YH
754 d., Simão CA. Evaluation of density influence on resistance to carbonation
755 process in oil well cement slurries. *Constr Build Mater.* 2019;197:331-338.
756 doi:10.1016/j.conbuildmat.2018.11.232
- 757 50. Bahafid S. A multi-technique investigation of the effect of hydration
758 temperature on the microstructure and mechanical properties of cement
759 paste. 2017. <https://pastel.archives-ouvertes.fr/tel-01980576>.
- 760 51. Fu T, Montes F, Suraneni P, Youngblood J, Weiss J. The influence of
761 cellulose nanocrystals on the hydration and flexural strength of Portland
762 cement pastes. *Polymers (Basel).* 2017;9(9). doi:10.3390/polym9090424
- 763 52. Cao Y, Tian N, Bahr D, et al. The influence of cellulose nanocrystals on the
764 microstructure of cement paste. *Cem Concr Compos.* 2016;74:164-173.
765 doi:10.1016/j.cemconcomp.2016.09.008
- 766 53. Lee HJ, Kim SK, Lee HS, Kim W. A Study on the Drying Shrinkage and
767 Mechanical Properties of Fiber Reinforced Cement Composites Using

- 768 Cellulose Nanocrystals. *Int J Concr Struct Mater.* 2019;13(1).
769 doi:10.1186/s40069-019-0351-2
- 770 54. Cao Y, Zavaterra P, Youngblood J, Moon R, Weiss J. The influence of
771 cellulose nanocrystal additions on the performance of cement paste. *Cem*
772 *Concr Compos.* 2015;56:73-83. doi:10.1016/j.cemconcomp.2014.11.008
- 773 55. Ecay L, Grégoire D, Pijaudier-Cabot G. On the prediction of permeability
774 and relative permeability from pore size distributions. *Cem Concr Res.*
775 2020;133(March):106074. doi:10.1016/j.cemconres.2020.106074
- 776 56. Melzer R, Eberhard E. Phase identification during early and middle
777 hydration of tricalciumsilicate (Ca_3SiO_5). *Cem Concr Res.* 1989;19(c):411-
778 422.
- 779 57. Sun X, Wu Q, Zhang J, Qing Y, Wu Y, Lee S. Rheology, curing temperature
780 and mechanical performance of oil well cement: Combined effect of
781 cellulose nanofibers and graphene nano-platelets. *Mater Des.* 2017;114:92-
782 101. doi:10.1016/j.matdes.2016.10.050
- 783 58. Akhlaghi MA, Bagherpour R, Kalhori H. Application of bacterial
784 nanocellulose fibers as reinforcement in cement composites. *Constr Build*
785 *Mater.* 2020;241:118061. doi:10.1016/j.conbuildmat.2020.118061
- 786 59. Jeong J, Sardini P, Ramézani H, Siitari-Kauppi M, Steeb H. Modeling of the
787 induced chemo-mechanical stress through porous cement mortar subjected
788 to CO_2 : Enhanced micro-dilatation theory and ^{14}C -PMMA method. *Comput*
789 *Mater Sci.* 2013;69:466-480. doi:10.1016/j.commatsci.2012.11.031
- 790 60. Jang JG, Lee HK. Microstructural densification and CO_2 uptake promoted
791 by the carbonation curing of belite-rich Portland cement. *Cem Concr Res.*

- 792 2016;82:50-57. doi:10.1016/j.cemconres.2016.01.001
- 793 61. Bruckdorfer RA. Carbon Dioxide Corrosion in Oilwell Cements. *Soc Pet*
794 *Eng.* 1986. doi:10.2118/15176-MS
- 795 62. Sauki A, Irawan S. Effects of Pressure and Temperature on Well Cement
796 Degradation by Supercritical CO₂. *Int J Eng Technol IJET-IJENS.*
797 2010;10(4):53-61.
- 798 63. Lesti M, Tiemeyer C, Plank J. CO₂ stability of Portland cement based well
799 cementing systems for use on carbon capture & storage (CCS) wells. *Cem*
800 *Concr Res.* 2013;45(1):45-54. doi:10.1016/j.cemconres.2012.12.001
- 801 64. Xu B, Yuan B, Wang Y, Zeng S, Yang Y. Nanosilica-latex reduction
802 carbonation-induced degradation in cement of CO₂ geological storage
803 wells. *J Nat Gas Sci Eng.* 2019;65(February):237-247.
804 doi:10.1016/j.jngse.2019.03.013
- 805 65. Costa BL de S, Freitas JC de O, Santos PHS, Melo DM de A, Araujo RG da
806 S, de Oliveira YH. Carbonation in oil well Portland cement: Influence of
807 hydration time prior to contact with CO₂. *Constr Build Mater.* 2018;159:252-
808 260. doi:10.1016/j.conbuildmat.2017.10.103
- 809 66. Morandea A, Thiéry M, Dangla P. Impact of accelerated carbonation on
810 OPC cement paste blended with fly ash. *Cem Concr Res.* 2015;67:226-236.
811 doi:10.1016/j.cemconres.2014.10.003
- 812 67. Ershadi, V., Ebadi, E., Rabani, A. R., Ershadi, L., & Soltanian H. Reduction
813 of set cement permeability in oil well to decrease the pollution of receptive
814 environment using spherical nanosilica. In: *2nd International Conference on*
815 *Environmental Science and Technology.* Vol 6. ; 2011:101-104.

- 816 68. Krakowiak KJ, Thomas JJ, Musso S, James S, Akono A, Ulm F. Cement
817 and Concrete Research Nano-chemo-mechanical signature of conventional
818 oil-well cement systems : Effects of elevated temperature and curing time.
819 *Cem Concr Res.* 2015;67:103-121. doi:10.1016/j.cemconres.2014.08.008
- 820 69. Neves A, Romildo J, Toledo D, Jo F. A study of CO2 capture by high initial
821 strength Portland cement pastes at early curing stages by new non-
822 conventional thermogravimetry and non-conventional differential thermal
823 analysis. *J Therm Anal Calorim.* 2017. doi:10.1007/s10973-017-6326-0
- 824 70. Ghabezloo S, Sulem J, Saint-Marc J. Evaluation of a permeability-porosity
825 relationship in a low-permeability creeping material using a single transient
826 test. *Int J Rock Mech Min Sci.* 2009;46(4):761-768.
827 doi:10.1016/j.ijrmms.2008.10.003
- 828 71. Bahafid S, Ghabezloo S, Duc M, Faure P, Sulem J. Effect of the hydration
829 temperature on the microstructure of Class G cement: C-S-H composition
830 and density. *Cem Concr Res.* 2017;95:270-281.
831 doi:10.1016/j.cemconres.2017.02.008
- 832 72. Sercombe J, Galle C. Rehydration and microstructure of cement paste after
833 heating at temperatures up to 300 ° C. 2003;33:1047-1056.
834 doi:10.1016/S0008-8846(03)00005-X
- 835 73. Ghabezloo S. Cement and Concrete Research Effect of the variations of
836 clinker composition on the poroelastic properties of hardened class G
837 cement paste. *Cem Concr Res.* 2011;41(8):920-922.
838 doi:10.1016/j.cemconres.2011.03.022
- 839 74. Mainguy M, Mod MM. Mod `eles de diffusion non lin ´eaire en milieux

840 poreux . Applications a la dissolution et au s ´ echage des mat ´ eriaux
841 cimentaires. 1999.

842 75. Huet B, Tasoti V, Khalfallah I. Energy Procedia A review of Portland cement
843 carbonation mechanisms in CO 2 rich environment . *Energy Procedia*.
844 2011;4:5275-5282. doi:10.1016/j.egypro.2011.02.507

845 76. Shen J. Reactive transport modeling of CO2 through cementitious materials
846 under CO2 geological storage conditions. 2013.

847 77. Kutchko BG, Strazisar BR, Lowry GV, Dzombak D a., Thaulow N. Rate of
848 CO2 Attack on Hydrated Class H Well Cement under Geologic
849 Sequestration Conditions. *Environ Sci \& Technol*. 2008;42(16):6237–6242.
850 doi:10.1021/es800049r

851 78. Morandea A, Thiéry M, Dangla P. Investigation of the carbonation
852 mechanism of CH and C-S-H in terms of kinetics, microstructure changes
853 and moisture properties. *Cem Concr Res*. 2014;56:153-170.
854 doi:10.1016/j.cemconres.2013.11.015

855

856

857

858

859

860

861

862

863 **Table Captions**

864 **Table 1.** MIP Tests

865 **Table 2.** Density and mass uptake after carbonation

866 **Table 3.** Intrinsic permeabilities

867 **Table 4.** Relative percentage of the crystalline phases before and after exposure

868 **Table 5.** Elastic properties measured by elastic waves velocities V_p and V_s

869 **Table 6.** Initial medium conditions for simulations

870 **Table 7.** Molar Volumes in cm^3/mol

871 **Table 8.** Initial conditions for the downhole simulation

872 **Table 9.** Values of κ for different values of κ_0

873 **Table 10.** Values of d_{eff} for different values of $d_{eff,0}$

874

875 **Table 1.** MIP Tests

Test	Reference	Curing temperature [°C]	BNC [%]	Carbonation days	Porosity [%]
1	PC-Reference	90	0	0	33.7
2	PC-NC	90	0	0	34.6
3	BNC05-NC	90	0.05	0	34.5
4	PC-30INT	90	0	30	24.5
5	PC-30EXT	90	0	30	21.5
6	BNC05-30INT	90	0.05	30	23.2
7	BNC05-30EXT	90	0.05	30	21.0

876

877 **Table 2.** Density and mass uptake after carbonation

Samples (III)		Initial density [g/cm ³]	Final density [g/cm ³]	Mass gained [%]
1	PC	1.89	2.14	13.5%
2	PC	1.89	2.15	13.5%
3	PC	1.89	2.13	12.4%
4	PC	1.89	2.15	13.4%
5	BNC05	1.87	2.12	13.5%
6	BNC05	1.87	2.13	13.7%
7	BNC05	1.88	2.12	12.6%
8	BNC05	1.87	2.09	11.8%

878

879 **Table 3.** Intrinsic permeabilities

Sample	k [m ²]
PC - NC	$3.4 \cdot 10^{-18}$
PC - C	$3.1 \cdot 10^{-19}$
BNC05 - NC	$3.2 \cdot 10^{-19}$
BNC05 - C	$2.6 \cdot 10^{-19}$

880

881 **Table 4.** Relative percentage of the crystalline phases before and after exposure

Crystalline phase (%)	PC Sample		0.05 sample	
	SC	C	SC	C
Portlandite	32	1	33	-

Katoite	28	-	29	-
Magnesite	10	-	5	-
Brownmillerite	16	6	15	7
Calcite	14	43	18	44
Aragonite	-	50	-	49

882

883

Table 5. Elastic properties measured by elastic waves velocities V_p and V_s

Sample	G [GPa]	K [GPa]	E [GPa]	ν
PC - NC	8.4	9.5	19.5	0.16
PC - C	8.9	12.7	21.3	0.22
BNC05 - NC	7.8	8.5	18	0.15
BNC05 - C	8.9	9.8	20.5	0.15

884

885

Table 6. Initial medium conditions for simulations

η_{vis} [MPa.s]	K_F [MPa]	ρ_F [kg/m ³]	R_c [MPa]	R_t [MPa]
$0.5 \cdot 10^{-9}$	2200	1000	24	2.4

886

887

Table 7. Molar Volumes in cm³/mol

v_{CH}^S	$v_{C-S-H_{1.6}}^S$	$v_{CaCO_3}^S$	$v_{SiO_2(H_2O)_{0.5}}^S$	$v_{H_2O}^F$
33.1	84.7	36.9	31	18.85

888

889

Table 8. Initial conditions for the downhole simulation

Inclusion	Volumetric prop. PC-BNC	Bulk modulus [GPa]	Shear modulus [GPa]
Porosity	0.345	-	-
CH	0.18	33.00	14.50
C-S-H	0.405	25.00	18.40
Aluminates	0.06942	27.00	9.50
Calcite	0.00	69.00	37.40
BNC	0.00058	42.00	38.00

890

891

Table 9. Values of κ for different values of κ_0

Porosity	Parameter κ_0 [m ²]					
	0.1	1	10	100	350	500
0.325	2.24E-19	2.24E-18	2.24E-17	2.24E-16	7.86E-16	1.12E-15

892

893

Table 10. Values of d_{eff} for different values of $d_{eff,0}$

Porosity	Parameter $d_{eff,0}$ [m ² /s]					
	0.1	1	10	100	160	300
0.325	7.27E-13	7.27E-12	7.27E-11	7.27E-10	1.16E-9	2.18E-9

894

Figure Captions896 **Fig. 1.** Carbonation equipment used897 **Fig. 2.** Samples cured at 90 °C and carbonated for 30 days (PC and BNC05)898 **Fig. 3.** Pore size distribution variation of oven-dried and non-oven-dried samples899 **Fig. 4.** Pore size distribution of carbonated and non-carbonated PC samples900 **Fig. 5.** Pore size distribution of carbonated and non-carbonated BNC05 samples901 **Fig. 6.** XRD patterns of non-modified cement (PC) and modified cement (BNC05) before
902 carbonation (NC) and after carbonation (C)

903 **Fig. 7.** Compressive strength and Young's Moduli variation after carbonation of PC and BNC05
904 samples

905 **Fig. 8.** 2D model. Representation of one-quarter sample subjected to carbonation using the code
906 BIL

907 **Fig. 9.** Left: Results of the simulation showing the variation of porosity in the experimental BNC05
908 sample of 38mm by 78 mm for values of $\kappa_0 = 350$ and $d_{eff,0} = 160$. Right: Results of porosity in 1D

909 **Fig. 10.** Dissolution and carbonation fronts development over time

910 **Fig. 11.** Permeability variation over time of an annular cement thickness of $\frac{3}{4}$ inch

911 **Fig. 12.** Volumetric proportions after 15 and 30 days of carbonation of an annular cement thickness
912 of $\frac{3}{4}$ inch

913

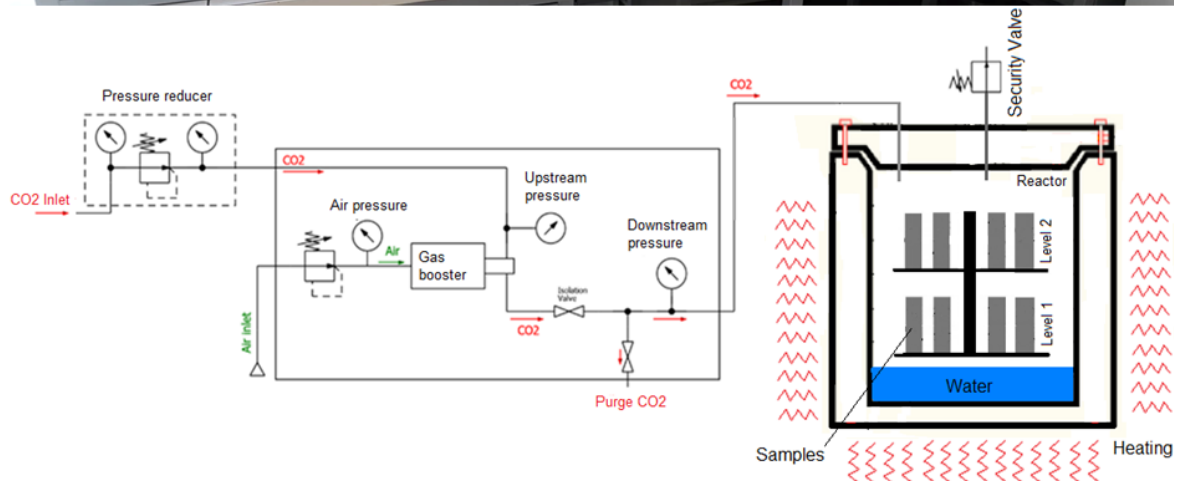

914

915 **Fig. 1.** Carbonation equipment used

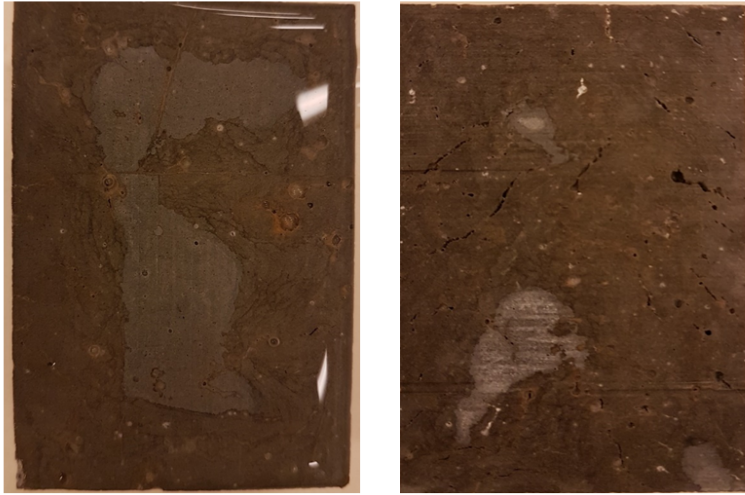

916

917 **Fig. 2.** Samples cured at 90°C and carbonated for 30 days (PC and BNC05)

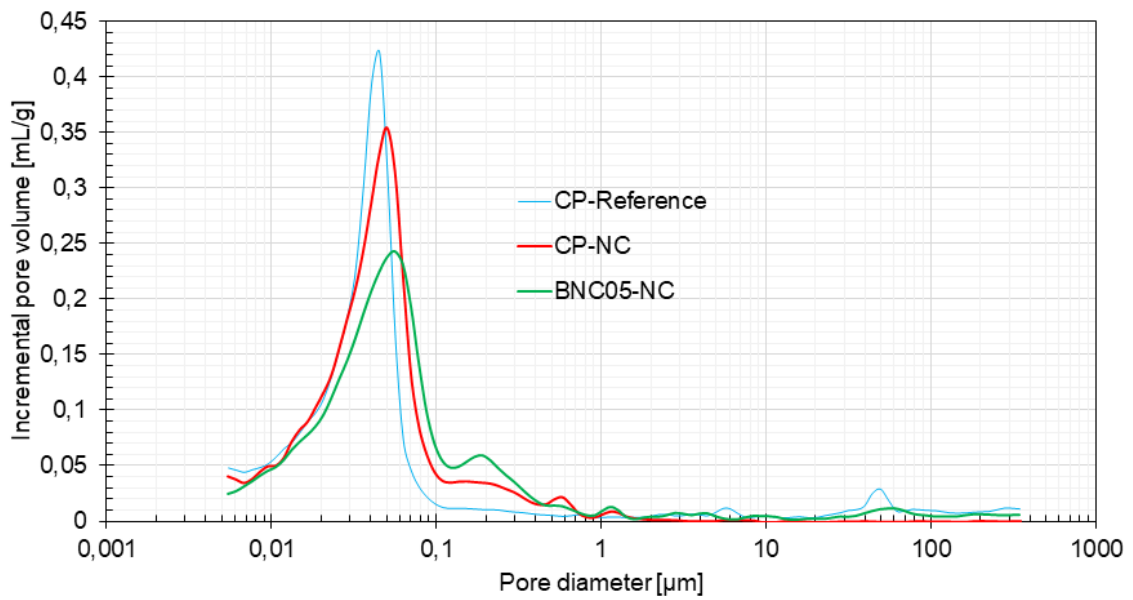

918

919 **Fig. 3.** Pore size distribution variation of oven-dried and non-oven-dried samples

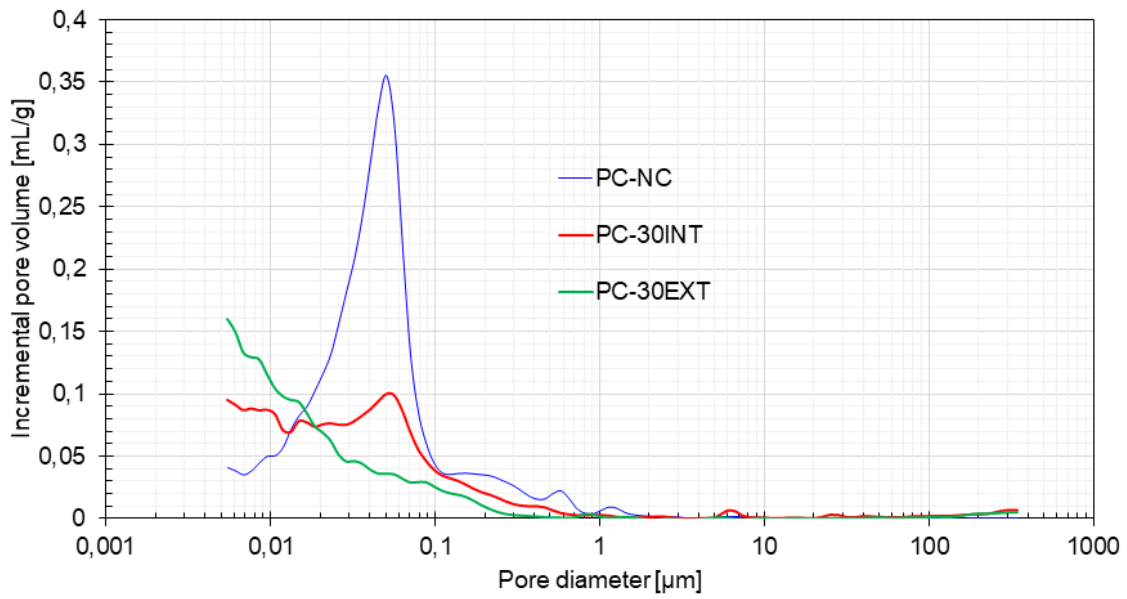

920

921 **Fig. 4.** Pore size distribution of carbonated and non-carbonated PC samples

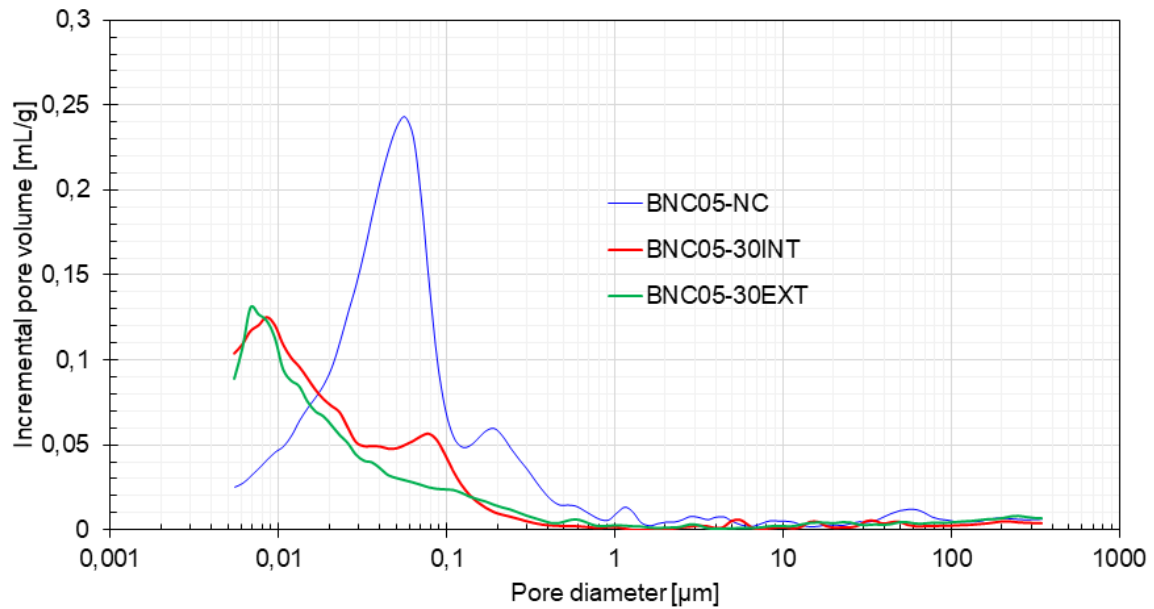

922

923 **Fig. 5.** Pore size distribution of carbonated and non-carbonated BNC05 samples

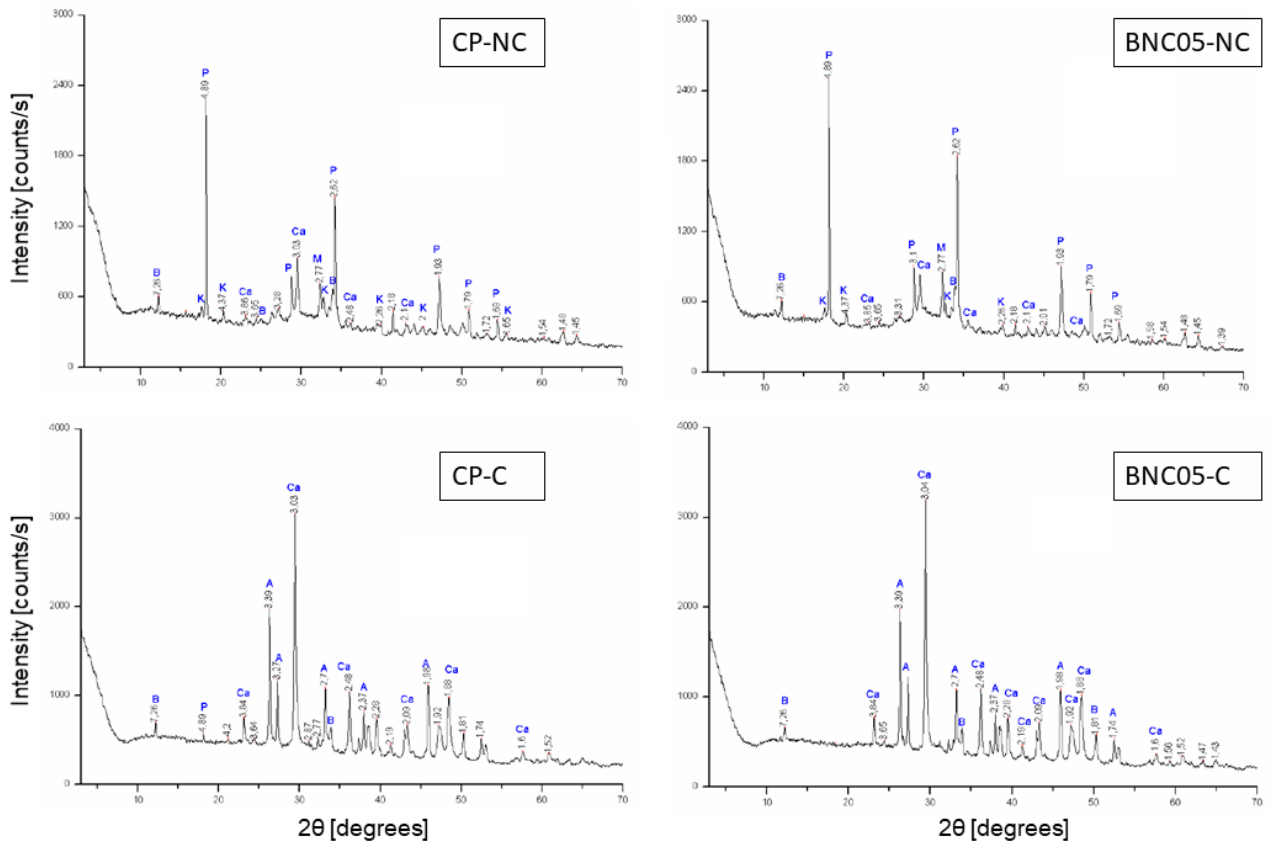

924

925

Fig. 6. XRD patterns of non-modified cement (PC) and modified cement (BNC05) before

926

carbonation (NC) and after carbonation (C)

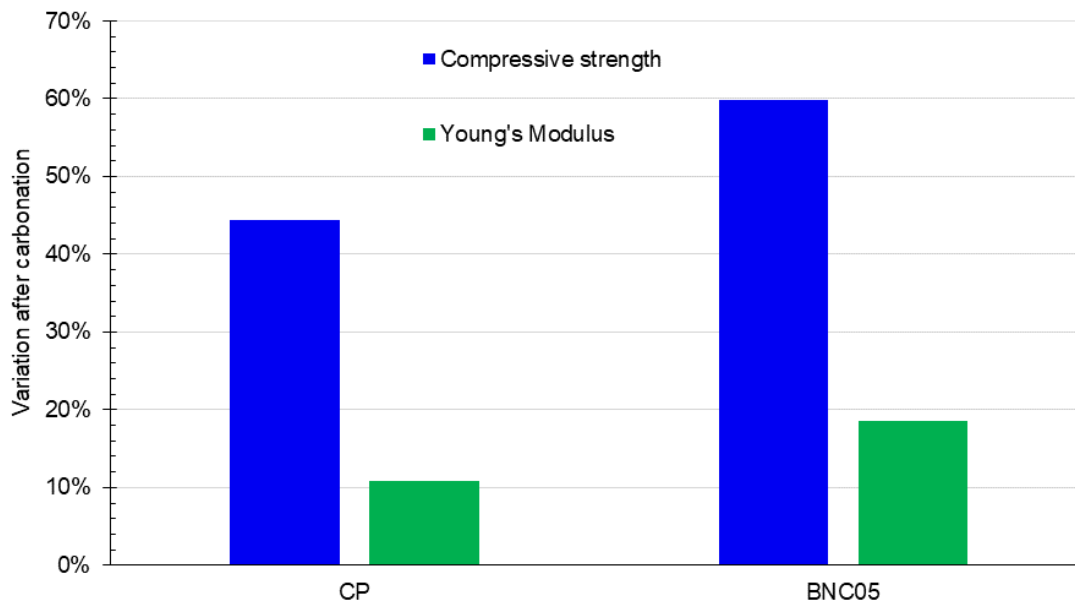

927

928

Fig. 7. Compressive strength and Young's Moduli variation after carbonation of PC and BNC05

929

samples

930

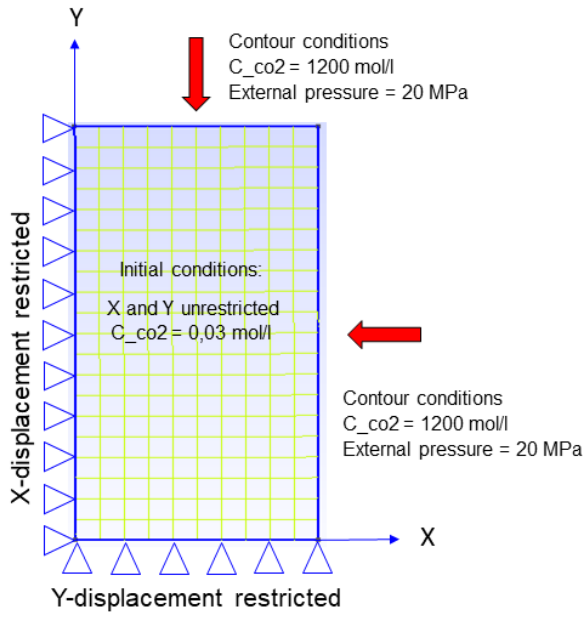

931

932 **Fig. 8.** 2D model. Representation of one-quarter sample subjected to carbonation using the code

933 BIL

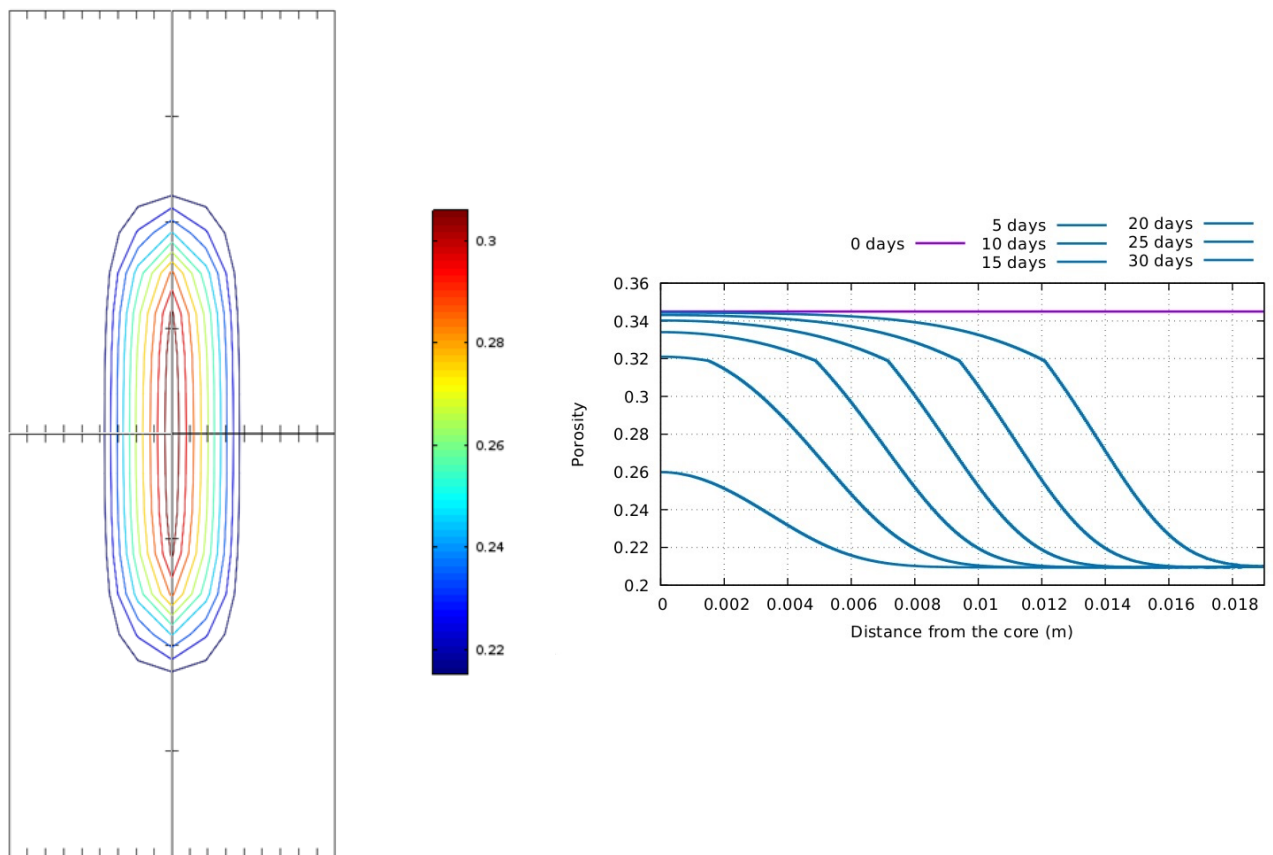

934

935 **Fig. 9.** Left: Results of the simulation showing the variation of porosity in the experimental BNC05

936 sample of 38mm by 78 mm for values of $\kappa_0 = 350$ and $d_{eff,0} = 160$. Right: Results of porosity in 1D

937 over the sample radius.

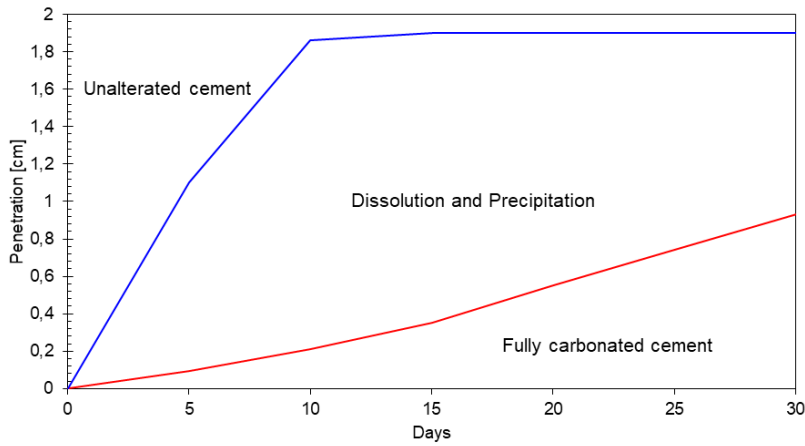

939 **Fig. 10.** Dissolution and carbonation fronts development over time

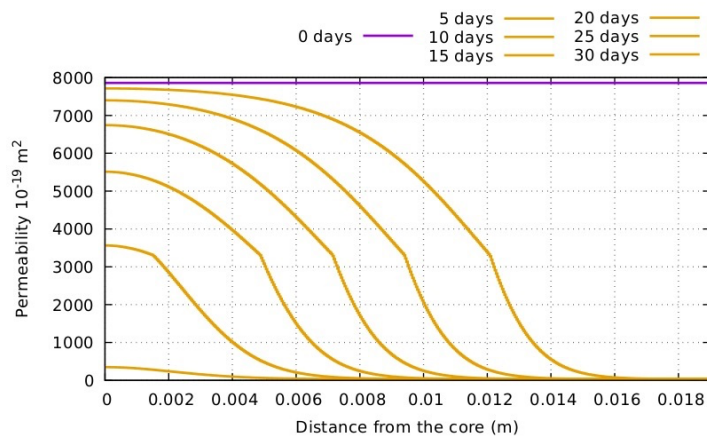

941 **Fig. 11.** Permeability variation over time of an annular cement thickness of 3/4 inch

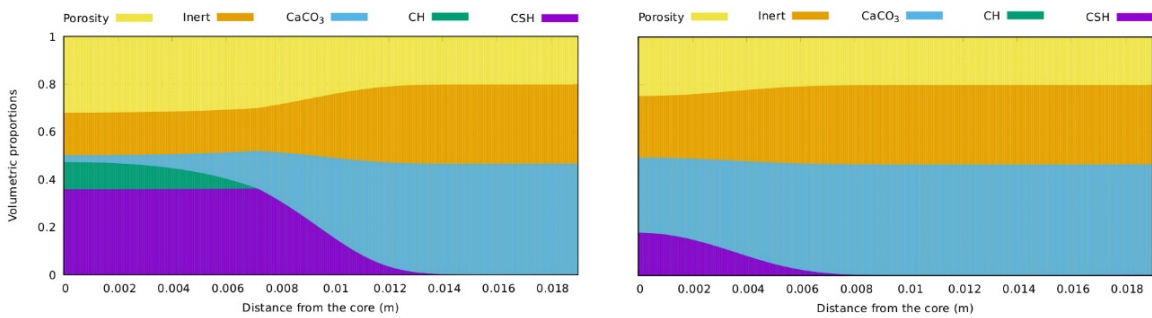

943 **Fig. 12.** Volumetric proportions after 15 and 30 days of carbonation of an annular cement

944 thickness of 3/4 inch