



HAL
open science

Stability and robustness of a 300 m² Composite Gridshell Structure

Frédéric Tayeb, Jean-François Caron, Olivier Baverel, Lionel Du Peloux

► **To cite this version:**

Frédéric Tayeb, Jean-François Caron, Olivier Baverel, Lionel Du Peloux. Stability and robustness of a 300 m² Composite Gridshell Structure. *Construction and Building Materials*, 2013, 49, pp.926-938. 10.1016/j.conbuildmat.2013.04.036 . hal-01774639

HAL Id: hal-01774639

<https://enpc.hal.science/hal-01774639>

Submitted on 23 Apr 2018

HAL is a multi-disciplinary open access archive for the deposit and dissemination of scientific research documents, whether they are published or not. The documents may come from teaching and research institutions in France or abroad, or from public or private research centers.

L'archive ouverte pluridisciplinaire **HAL**, est destinée au dépôt et à la diffusion de documents scientifiques de niveau recherche, publiés ou non, émanant des établissements d'enseignement et de recherche français ou étrangers, des laboratoires publics ou privés.

Stability and robustness of a 300 m² Composite Gridshell Structure.

F. Tayeb ^a, J-F. Caron ^a, O. Baverel ^{a b}, L. Du Peloux, ^a.

^a UR Navier, Université Paris-Est
Ecole des Ponts ParisTech, 6-8 avenue Blaise Pascal, 77455 Marne la
vallée cedex 2, France

^b Ecole Nationale Supérieure d'Architecture de Grenoble
60, rue de Constantine 38000 Grenoble, France.

frederic.tayeb@enpc.fr, +33164153788; caron@enpc.fr, +33164153741;
oliver.baverel@enpc.fr, +33164153732; lionel.du_peloux@durashell.fr
Fax: +33164153741

Corresponding author:

Sebastian Wendel, **wendel.sebastian@bristol.ac.uk**

Abstract:

In this paper, ductility aspects of a light-weight composite gridshell are developed. A gridshell is a very light structure that can support relative high loads. For many reasons, the materials used by the Navier laboratory are glass fibre reinforced polymers (GFRP) that have elastic brittle behaviour. To ensure the safety of people these structures have to behave in a ductile way, that is to say they must not collapse without showing signs of weakness. This paper deals with the pseudo-ductile behaviour of the GFRP gridshells designed by the Architected Structures and Materials research unit of Navier laboratory.

After a reminding context about gridshells, the buckling of the Solidays' festival gridshell prototype (June 2011) is considered. It is demonstrated that buckling has to be avoided carefully because it fosters high stresses in the beams and may lead to a brutal collapse of the structure. Then it is shown that, under Ultimate Limit State (ULS), the gridshell prototype is far from buckling. Finally, a simulation of accident is performed: from the ULS, several elements are broken in order to understand the behaviour of the structure in case of accident. The pseudo-ductility of the structure is demonstrated thanks to the redundancy of the structural concept of the gridshell.

Keywords: Gridshell, GFRP, pseudo-ductility, redundancy, non-linear analysis, ultimate limit state.

1. Introduction

In the last twenty years many applications of composite materials in the construction were made (see for example [1]). The main field of application concerns the reinforcement of concrete beams with carbon fiber plates [2], [3], post tension cables [4] or all-composite structures [5]. Nevertheless applications using composite materials as structural elements remain exceptional in comparison with concrete, steel or even wood. Although the qualities of their mechanicals properties are obvious (low density, high strength and high resistance against corrosion and fatigue), their relatively low elastic modulus may appear as a disadvantage compared with steel. Indeed most slender structures in structural engineering are designed according to their stiffness and rarely to their strength. Moreover, the elastic instabilities depend linearly on the Young modulus, so that again, having a low Young modulus can be considered as a real disadvantage when a designer tries to calculate structure based on conventional design structure. In order to take advantages of every characteristic of composite materials, new structural concepts have to be found.

The Navier laboratory is working on the development of innovative solutions for composite material in civil engineering. Four design principles guided the conception of the structures:

- Optimal use of the mechanical characteristics of the fibres, including their deformability.
- Simple connection between components of the structure;
- Optimal design according to its use;
- Cheap material cost toward use of components already available in the industry.

Several structures were investigated such as an innovative footbridge [6] and several experimental gridshells [7], [8], [9]. The last one built for the Solidays' festival (June 2011, Paris [5]) was built to house 500 people. In the present paper, gridshells refers to flat regular grids that are deployed to obtain complex 3D shapes (Frei Otto concept [10]). More precisely, the shapes considered are double-curvature shells providing important structural rigidity. Information about the design and the building process of the Solidays' gridshell is provided in the section 2.

As previously said, the gridshells are a continuation of the works of Frei Otto who constructed the Mannheim Bundesgartenschau gridshell, made of wood [10]. As said, the wood was chosen for the elements of the gridshell. It is important to know that wood beams and composite pultruded beams behave similarly. However, now that the manufacture of composite beams has been developed, composite beams

have better mechanical properties, but most important of all, have better reproducibilities, that is to say they have a low dispersion.

Chris Williams was a member of the team who worked on the finite elements' study for the Mannheim gridshell. Using his works and the works of his colleague from the Bath University, Michael Barnes [11], [12], [13], he developed a program based on dynamic relaxation algorithm to investigate shapes with bended elements.

Obviously, a construction made to shelter people has to be safe, even in accidental situations. The purpose of this paper is to show that GFRP gridshell structures have a ductile behaviour, that is to say that their behaviour would warn people of a danger before the total collapse of the structure. In other words, it would give enough time for evacuating the room. Considering FRP, Ductility is a concept which can be assimilated with robustness sometimes. In particular, if the structure is able to dissipate energy without losing significant resistance it might be classified as ductile. Actually, one of the restraints for the use of GFRP by engineers is their apparent brittle behaviour. However, several concepts have been adopted to improve ductility of constructions using FRP [14], [15]. Indeed, such a structure can have a robust behaviour either because of redundancy or because of its ability to deform largely [16]. A classification of ductility is proposed in [14]: a structure can be:

- ductile if it includes a combination of brittle and ductile components,
- pseudo-ductile if it includes only combinations of brittle components.

In particular, for FRP structures, several processes of ductility can be used. The most common are listed below:

- Redundancy
- Addition of ductile elements.
- Addition of fragile elements breaking for solicitations lower than that which fosters the collapse of the structure.

In this paper many details are given about the gridshell designed by the Navier laboratory, using brittle materials. Then, with the help of the numerical simulation used to design the Solidays' gridshell, a study of the buckling is performed and comes to the conclusion that buckling has to be carefully avoided. Then, an ultimate limit state is studied in order to have an idea of the margin remaining before buckling. Finally, a process to evaluate the ductility behaviour of the structure is performed: the behaviour of the structure is analysed while critical elements are progressively removed, to simulate an accident.

2. Description of a composite gridshell: design and fabrication

As explained before, the Solidays' gridshell has an important role in this paper. Information about the design and the construction process of the gridshell is reminded in this section. As previously explained, the gridshells built by the Navier laboratory are made of a flat composite grid deformed elastically to obtain the shape desired. The design of the gridshell is based on many numerical simulations. So, an important step is to collect information about materials, to perform realistic numerical simulations. Finally the building of the gridshell can be achieved. In this section, the material specificity of the composite beams is studied. Then the design of the Solidays' gridshell is reminded. Finally, the building process of the gridshell is developed and illustrated.

2.1 Material specificity of composite beams.

To design a structure, engineers need information about materials. International standards and rules do not exist yet for composite materials. Thus, determining the properties of the beams that compose the structure is obligatory. The beams chosen to build the gridshells are pultruded tubes geometrically characterized by their outer diameter d and their thickness t . The tubes are made with glass fibres and polyester resin. To simplify the transport the tubes have a length of 12 m. Nonetheless, for a huge structure, the tubes can be produced continuously on site, which would allow very large lengths.

Thus, to determine the mechanical properties of the beams several experiments have been performed. In particular, three points' bending tests have been performed (figure 1) to obtain the mean strength, as well as information about the statistical dispersion. During these tests, a tube is pulled in its centre with a scaffolding element. Two additional supports complete the experimental assembly. The choice of the use of a scaffolding element is not insignificant since the connections of the gridshell are made like that. 15 tests have been performed upon tubes characterized by $d = 41$ mm and $t = 3$ mm. The results are detailed in the table 1: the experimental mean value of the strength of the composite material, \bar{R} , is 480 MPa; It represents the value of the stress in the upper and lower part of the beam. The upper part is in traction when the lower part is in compression (figure 1). The experimental coefficient of variation relative to the strength, C_v , is equal to 3 %. The dispersion is very low because the fabrication of pultruded profiles is well controlled. This GFRP has to be compared with wood: for solid wood, the Coefficient of variation commonly reaches 100 %; for industrials products such as laminated wood, it commonly reaches 50 %. The high reproducibility for GFRP pultruded beams is a real advantage.



Figure 1: Three points' bending tests performed on gridshell beams.

Tube	Exp. strength \bar{R} (mean value)	Exp. coefficient of variation Cv	Strength (com. data)	Coefficient of variation (com. data)
GFRP Pultruded	480 MPa	3%	440 MPa	Not disclosed

Table 1: Data about composite profiles' mechanical properties

To take into account these experimental results in the following, the strength of each element is drawn according to a Weibull law whose mean value and coefficient of variation are respectively 480 MPa and 3 %. The cumulative distribution function of this Weibull law is represented in the figure 2. The experimental points are also reported on the figure 2.

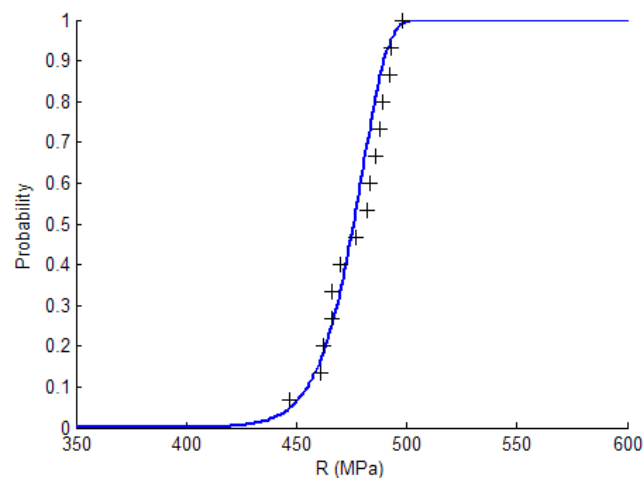

Figure 2. Cumulative distribution function of the Weibull law for R (blue)
Experimental points (+)

At this point, the material is characterized. Creep behaviour is not studied here, although it is an important aspect to deal with. Nonetheless, creep aspects are taken into account thanks to the safety factor discussed in the next sub-section.

So the design of the structure can be started. In particular, the numerical design is developed in the next sub-section.

2.2 Structural design of the gridshell

In this sub-section, the numerical design of the gridshell is performed. First, design rules have to be chosen for the material and structure prescriptions, and then have to be cautiously followed. It gives important information about the coefficient factor which has to be used.

The design of the structure refers here to the Eurocomp design code [17]. Since the structure is reasonably flexible, it has been designed regarding the serviceability limit state (SLS). In particular, that imposes that the most important displacement of a point of the structure must not exceed 60 mm, under any SLS loads. The structure has also to resist to ULS cases. These cases correspond to the worst conceivable load cases (they include safety factors). As said before, the beams have an elastic strength \bar{R} of 480 MPa. But, a material resistance factor has to be carefully considered. For ULS cases, this factor γ_m is the product of three partial coefficients [17], formula (1).

$$\gamma_m = \gamma_{m,1} \gamma_{m,2} \gamma_{m,3} \quad (1)$$

The first partial coefficient, $\gamma_{m,1}$, reflects the materials. The value of $\gamma_{m,1}$ is equal to 1.15 for this type of pultruded tubes. The second, $\gamma_{m,2}$, reflects the uncertainty fostered by the production process. Its value is set to 1.1 in the case of the pultruded beams. The third one, $\gamma_{m,3}$, depends on environmental effects and duration of loadings. It is the most influential partial safety factor to consider. The table 2, drawn from the Eurocomp [17], provides the values for this coefficient. The parameters considered in this table are the operating design temperature (ODT), the heat distortion temperature (HDT) and the duration of the loading. The HDT is the temperature at which a polymer or plastic sample deforms largely under a specified constant load. For the pultruded beams used, having a heat distortion temperature between 70-80 °C, the values of $\gamma_{m,3}$ for a typical operating environment (0 - 25°C) are respectively 1.0 and 2.6 for short and long term loading,.

Operating design temperature (°C)	Heat distortion temperature (°C)	$\gamma_{m,3}$	
		Short term loading	Long term loading
25 - 50	55 - 80	1.2	3.0
	80 - 90	1.1	2.8

	> 90	1.0	2.5
0 - 25	55 - 75	1.1	2.7
	70 - 80	1.0	2.6
	> 80	1.0	2.5

Table 2. Values for $\gamma_{m,3}$ (Eurocomp [17])

In agreement with the CTS organism (the CTS organism checks and gives attestations for non permanent structures such as big tops, tents and structures) it was concluded that a material resistance factor of 2.35 should be relevant (a $\gamma_{m,3}$ of 1.8 is chosen; it corresponds to an arbitrary interpolated middle term loading, not inventoried in the table). Indeed, the structure had to stand less than three weeks. As a consequence, the maximal stress accepted for the design of the Solidays' structure is $R_d = 204$ MPa. Thus, the Weibull distribution is modified, as illustrated in the figure 3. It provides the statistic used for strength, in the following simulations.

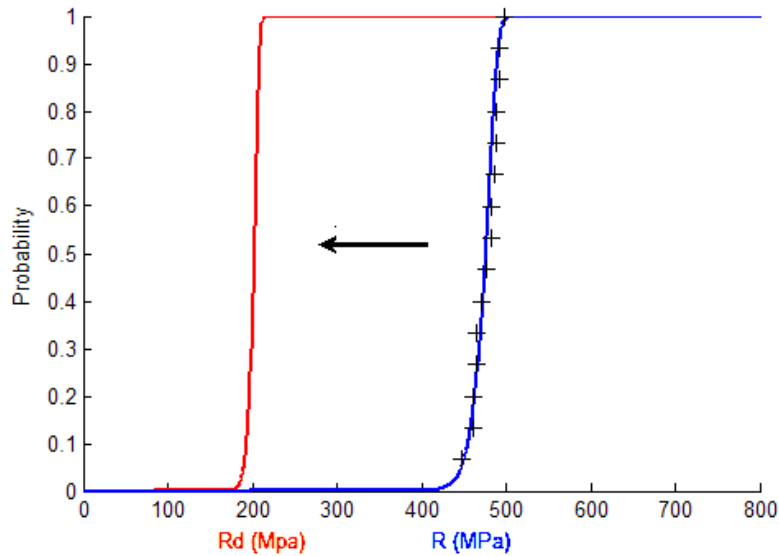

Fig 3. Cumulative distribution function R_d obtained from R through the 2.35 safety factor

At this point, the design strictly speaking is started. At the beginning, a desired rounded shape is proposed by an architect. A first reflexion is necessary, to know if the shape proposed is suitable with the gridshell technology. If it is, the design can start. The surface proposed by the architect is drawn in drawing software. The surface is extended and two intersecting curves are drawn on the surface (Figure 4, a). The compass method (see [5]) is performed to get a primary grid, using the two curves (Figure 4, b). The grid is then trimmed to get a geometrical primary gridshell (Figure 4, c). This process, created under Rhinoceros[®]-Grasshopper[®] environment, is explained in details in [5].

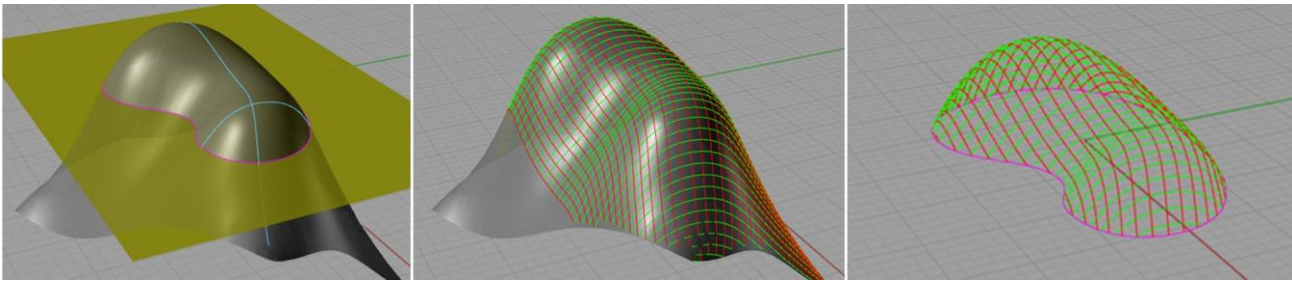

Fig 4. Generation of the primary grid: a. Extension of the surface to mesh. b. Meshing of the extended surface. c. Cutting of the mesh obtained to keep the useful part.

The following step is the relaxation of the grid. An algorithm based on dynamic relaxation makes possible the investigation of the final “natural” shape of the gridshell. From a purely geometric grid, the relaxation of the pre-stressed beams provides a grid which has a real mechanical meaning: the grid reaches its mechanical equilibrium. Since the grid boundary conditions are only located on the contour of the shape, it appears clearly that the contour definition of the grid is very important: a slightly modification of the contour might generate important modifications of the final shape.

Once a satisfactory shape is obtained, the structure is numerically studied in response to the loads given by construction codes. The gridshell can be strengthened or weakened to adapt it to the loads. Modifications of shell stiffness can be done through:

- The mesh width,
- The geometrical properties of the beam that can change flexural rigidity,
- An iterative modification of the shape to modify curvatures,
- The modification of the two initial curves used arbitrary to generate the mesh.

2.3 Construction of the prototype

Once a satisfactory solution has been found, the achievement can start. After a numerical simulation of the erection with the same numerical tools (not detailed here), the physical erection can be done. The erection process is illustrated below: the primary grid is assembled on the ground (Figure 5). The connections used are scaffoldings elements. They have a rotational degree of freedom in the plane of the grid so the quadrangles forming the grid can deform easily in the plane of the grid. Then, the erection of the grid is done, with the help of to cranes for the festival Soliday’s (Figure 6). Each beam located on the edge of the grid is brought to its correspondent anchorage, and in the same time the shape of the grid comes closer to the one foreseen during the design step. The grid is then braced with a third layer of beams which confers its high stiffness (figure 7).



Fig 5. Assembling of the primary flat grid on the ground, near the anchorages



Fig 6. Positioning of the grid with crane



Fig 7. Gridshell anchored and braced

The gridshell is then covered with a textile canvas that makes it highly sensitive to wind, due to its large area. Of course, the wind loads have been considered for the design of the structure.

The Solidays' project, from the native idea to the achievement of the gridshell, is the result of a fruitful collaboration with our partners, especially the student team involved in the project, the department of Civil Engineering of Ecole des Ponts ParisTech, the firms that took the responsibility of the project and the support partners.

Concerning the ductility aspects, the Solidays' gridshell, composed of GFRP brittle beams, use metal connection between the beams. Since steel scaffolding nuts available on the market are used, the connection nuts are over-dimensioned. Thus, no ductility can be obtained through the connections. So, the only potential source of ductility must be the result of the redundancy of the gridshell structure. This assumption is studied in the fourth section of the paper.

At this point of the article the gridshell has been defined and designed. To characterize its ductility, it is important to understand its failure modes. The common sense is the following: if the structure has been properly designed, small displacements would not be supposed to endanger the structure. But, if the structure starts buckling, large displacements might exist. These eventual large displacements could foster overstress

and damage. That is the reason why the buckling of the gridshell is investigated in the next section, to avoid cautiously this buckling, in the following.

3. The buckling of the gridshell: a situation to avoid

As explained before, the buckling of the structure might foster overstress and damage. Thus, the process of buckling has to be studied. The following investigation of the buckling process has been made using finite element model. The numerical simulation is based on a non linear analysis: the dynamic relaxation. Due to large displacements, the dynamic relaxation algorithm is a good method for gridshell form-finding [9], [11], [13], [18]. To study buckling a simple process has been followed: the gridshell undergoes a load which is increased up to the ruin of the structure. For simplicity reasons the load chosen here is similar to a snow load. This situation is modelled with vertical nodal forces distributed on the nodes located in the flat upper part of the gridshell (162 nodes, figure 8). Concerning the boundary conditions, the nodes located on the edge of the structure are prescribed to no displacement (but rotations are allowed).

The elements of the structure are considered to behave elastically, and stress value in each element is calculated to know if a beam is still resistant or if it is broken. Then, the force is progressively increased. The load necessary to foster the first break is pointed out.

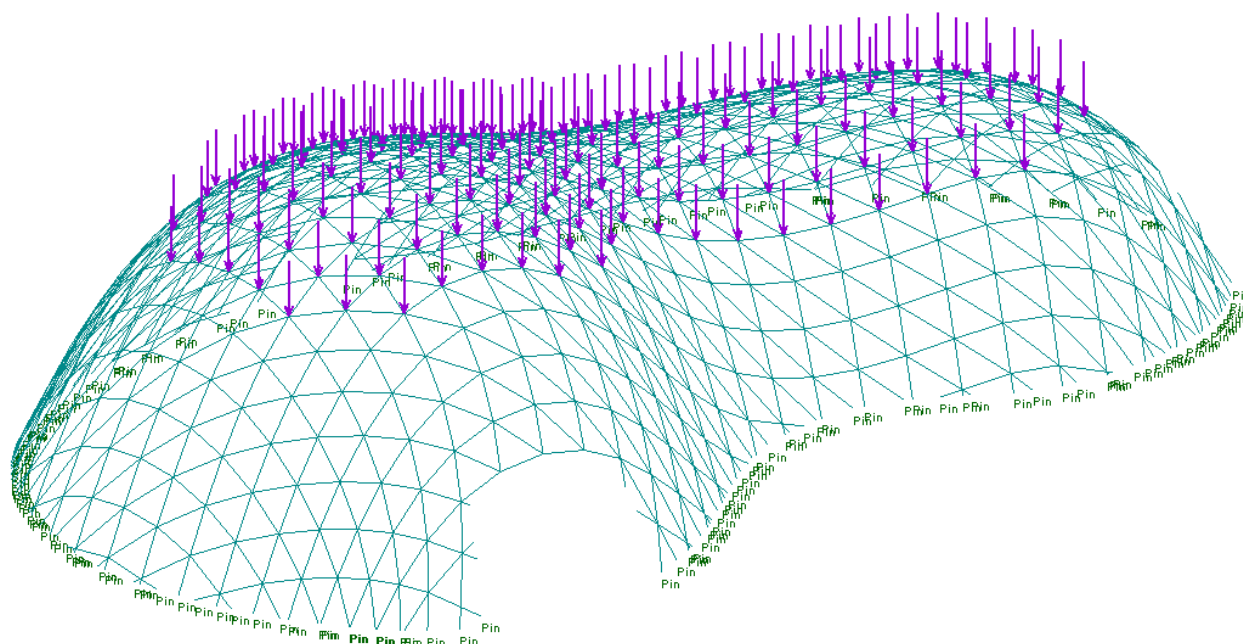

Fig 8. Snow load modelling

The nodal forces are increased from zero to 1.36 kN, which correspond to a total snow load F ranged from zero to 220 kN (1.9 kN/m²). The displacement of each node is recorded, as well as the maximal stress in each element. It is interesting to plot the maximal stress σ_{\max} , as well as the maximal displacement U_{\max} and the mean displacement \bar{U} , versus the total vertical load F applied to the gridshell (figures 9, 10,

11). The mean displacement U_{\max} and the maximal displacement \bar{U} are calculated respectively by the formulas (2) and (3).

$$U_{\max} = \text{Max} \sqrt{x_i^2 + y_i^2 + z_i^2} \quad (2)$$

$$\bar{U} = \frac{\sum_i \sqrt{x_i^2 + y_i^2 + z_i^2}}{Nt} \quad (3)$$

Where the index i characterize the node i , and Nt is the total number of nodes.

The results are the following: the gridshell first reacts elastically (figures 9, 10, 11). Then the gridshell starts buckling (in this case, for a vertical load F of around 200 kN (1.7 kN/m²)). From this point, the stresses start increasing very fast and reach quickly the weakest strength of a critical beam. As explained further, the important outputs are the ratio stress over strength, β_j . For the element j , the ratio is calculated by (4):

$$\beta_j = \frac{\sigma_{\max}^j}{R_d^j} \quad (4)$$

where σ_{\max}^j is the maximal stress in the element j , and R_d^j is its strength, draw according to the Weibull law R_d (figure 3).

They are calculated for each element, at each step of the numerical study.

The figure 9 provides information about damaging: at first, the maximal stress in the beams is almost insensitive to loads. That is not surprising since it has been proved that the stress is mainly due to the form-finding [5]. This property of the composite gridshell is not usual and is an advantage for its reliability: whatever the load, the stress state is very regular and can be known accurately even if the load is not well-known.

Then, when buckling starts, the maximal stress starts increasing fast. Indeed, for a load about 206 kN, the stress in a given critical beam reaches its statistical strength. This situation is marked with the vertical green dotted line. It is important to keep in mind that, according to the design code [17], the admissible strengths are close to the mean value of 204 MPa, for an ultimate real strength \bar{R} of 480 MPa. So, if the buckling is avoided, the safety margin is important.

But if the buckling begins, the beams break successively and the gridshell would collapse progressively but more and more rapidly since the load is maintained.

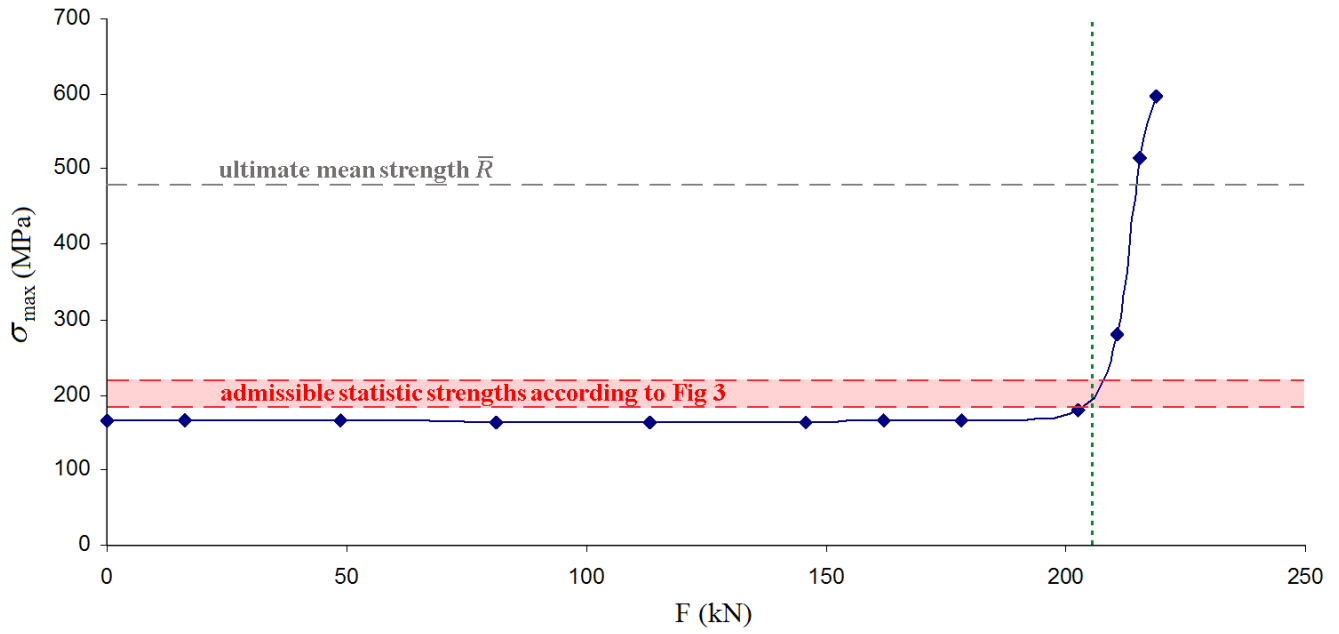

Fig 9. Maximal stress (MPa) versus vertical load (kN), for an elastic gridshell

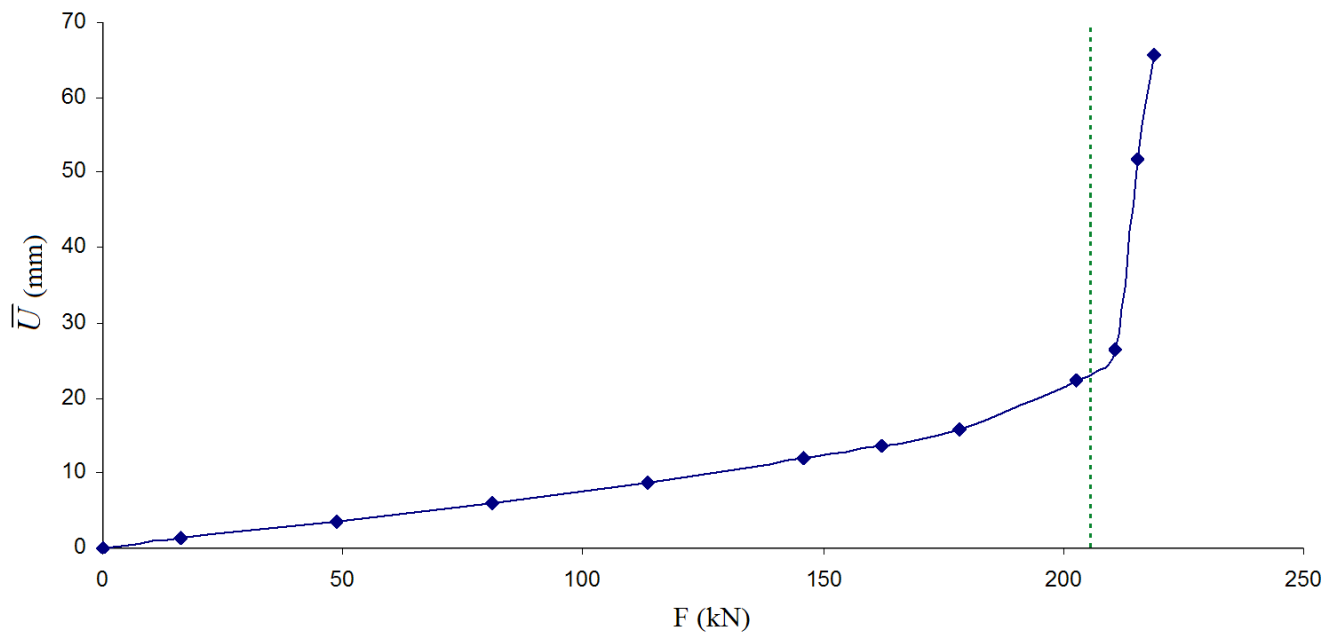

Fig 10. Mean of nodes' displacement (mm) versus vertical load (kN), for an elastic gridshell

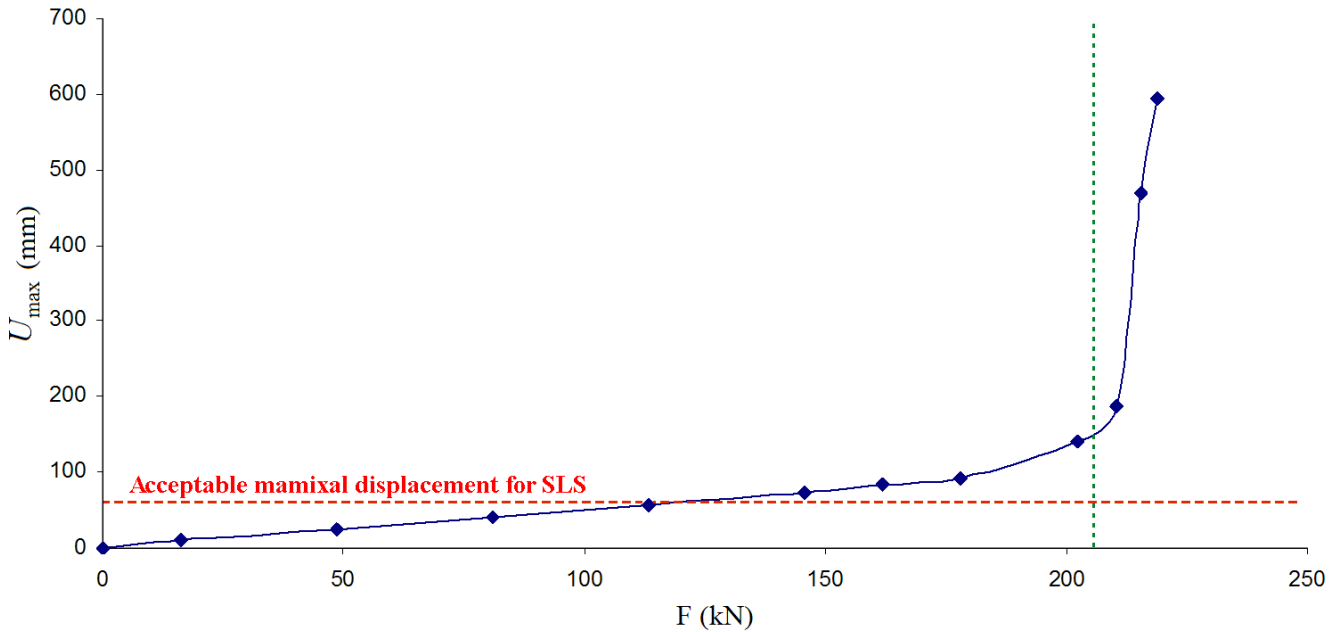

Fig 11. Maximum displacement (mm) versus vertical load (kN), for an elastic gridshell

Concerning displacements, just before the first crack, the mean displacement and the maximal displacement are respectively equal to 23 mm and 150 mm. One can note that this maximal displacement is larger than the 60 mm acceptable for the SLS (marked by the red dotted line). At this point, such displacements are significant, and surely, they can be noted by an occupant of the structure.

In summary, as for steel or concrete structure, the buckling of the gridshell would lead to a quick collapse of the structure. This hypothetical situation must absolutely never happen in practice. Indeed, the structure has been designed to never buckle through the use of the Eurocode. In the next section, the behaviour of the gridshell structure is at stake: the gridshell is considered in the most unfavourable environmental conditions likely to occur, that is to say a critical ULS case, and then, several simulated accidents affecting the structure are studied, to characterize the type of behaviour.

4. Pseudo-ductility of the gridshell

In the previous section, it has been demonstrated that, as for any classical structure, any gridshell must not buckle for a safe use. In this section the choice of an ULS case to study is presented. Then, besides the ULS load, an accidental situation is studied. The response of the gridshell to this accidental situation is examined, to investigate the ductile behaviour of the gridshell.

4.1 presentation of the case of study

In agreement with the CTS organism, it has been concluded that the significant ULS cases are a combination of rough wind, dead weights (including potential summer snow) and, most important of all, the pre-stress due to the shaping of the grid. Of course, these design loads include safety factors. It has been also demonstrated that the winds coming perpendicularly to the main axis of the gridshell have more impact on it (East or West

winds). As a consequence, a significant ULS case is developed below. It corresponds to a wind coming from the East, combined with the pre-stress and the dead weights.

It is important to keep in mind that the main part of the stress is due to the forming. In comparison, the stress resulting from wind is about 6 % of the total stress, and the dead weights represents less than 1 % [5].

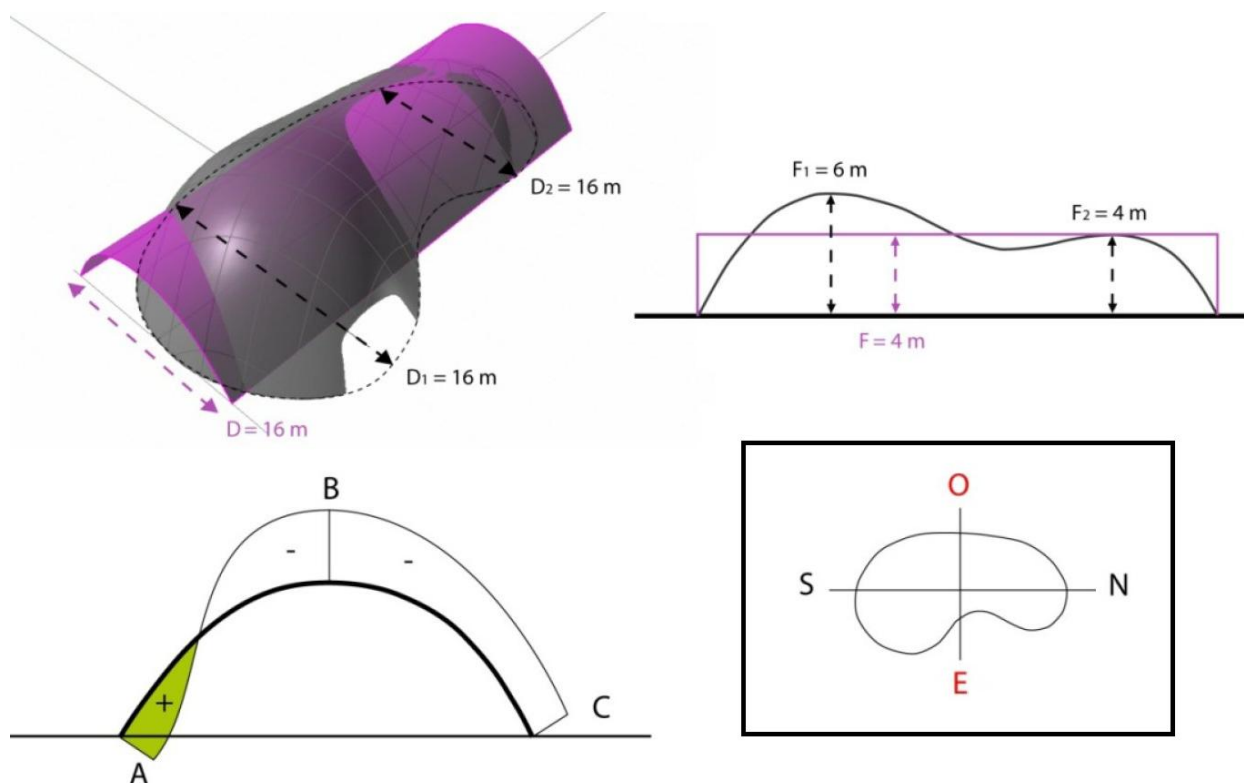

Fig 12. Pressure distribution chart for East / West winds.

The response of the gridshell to this ULS case has been analysed once again using dynamic relaxation. In particular, this simulation leads to the conclusion that the gridshell does not buckle for the ULS case, which was foreseen.

It is important to definitely measure the ULS load margin before buckling. To do so, the ULS loads have been multiplied by a coefficient α between 0 and 3. For each coefficient the non-linear analysis has been performed and the maximal stress in the structure is picked up. The figure 13 shows the results: for the ULS load ($\alpha = 1$, marked with the green vertical dotted line), the gridshell is far from the buckling. The buckling would occur for $\alpha \approx 1.5$.

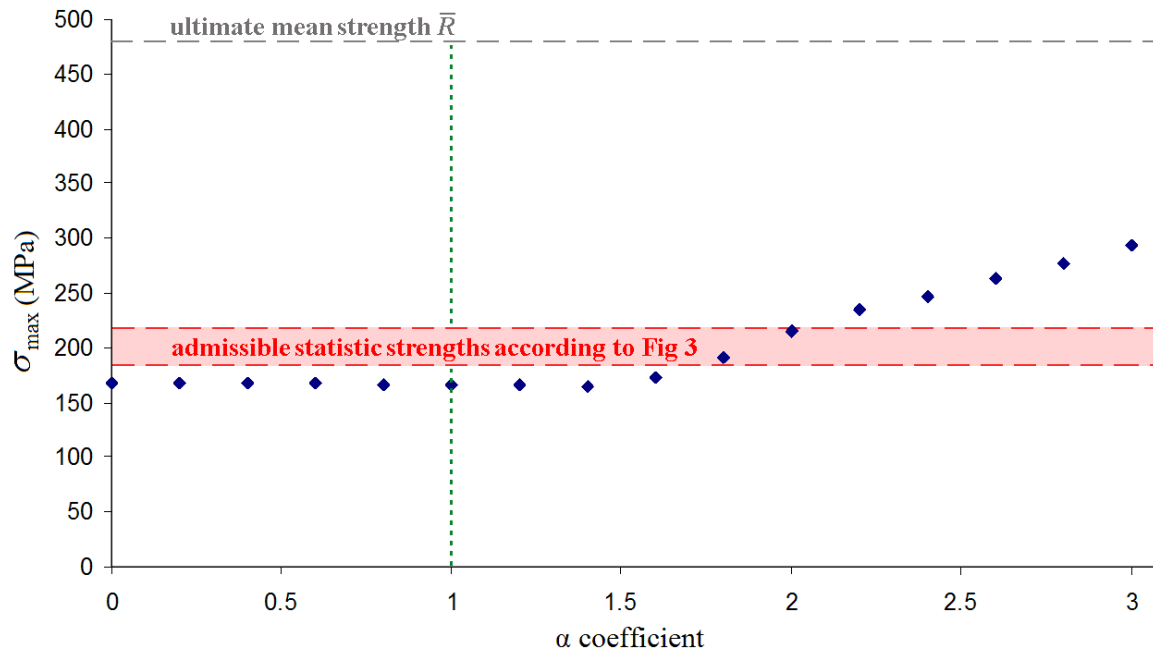

Fig 13. ULS load margin before buckling

The ULS case chosen is the reflect of the worst environmental conditions that might affect the structure. It is also the framework of the following study.

To carry on with the investigation of ductility it is interesting to understand the behaviour of the gridshell in an accidental situation. To simulate an unfavourable situation, a case when elements break for a reason or another is considered. The main reasons for breaking could be a bad way of production of the beams, or if they undergo shocks during transport, or if the structure is subject to vandalism. The simulation proposed makes possible the understanding of the gridshell collapse. In addition, it gives information about delay for evacuating, before a potential collapse.

At first, the common sense would be the following: it is probable that the structure will resist easily when a small number of elements is broken, due to the redundancy of the highly hyperstatic structure.

To verify this idea, the behaviour of the gridshell is studied, once again using finite element software through non linear analysis. The investigation is the following: the most stressed element is broken since it is the most likely to break. Since the statistical dispersion is still considered, the most stressed element is the element whose ratio β_j is maximal. Thus, the highly curved beams are mainly concerned. This situation represents the most unfavourable case because the highly curved beams stock much energy. In addition, one can note that the most curved elements play an important role in preventing the gridshell from buckling. Since it has been noticed that the total ruin of the structure would occur if it starts buckling, breaking the most stressed element is, once again, the most unfavourable process. The accidental process can now be conducted upon the Solidays' gridshell.

4.2 Pseudo-ductility in accidental situation

It has been reminded that the grid has been assembled flat and then deformed elastically to the desired shape. As a consequence, the elements of the structure are pre-stressed (figure 14). The ULS load is then applied upon the structure and one can note that the stress values change slightly. In particular, in the area circled in black, the stress has increased a little. As written before, the increase of stress due to ULS load does not exceed 6 %. Indeed, in the case of such a gridshell, the stress is linked with the curvature of elements and curvature is mainly due to the shape of the gridshell.

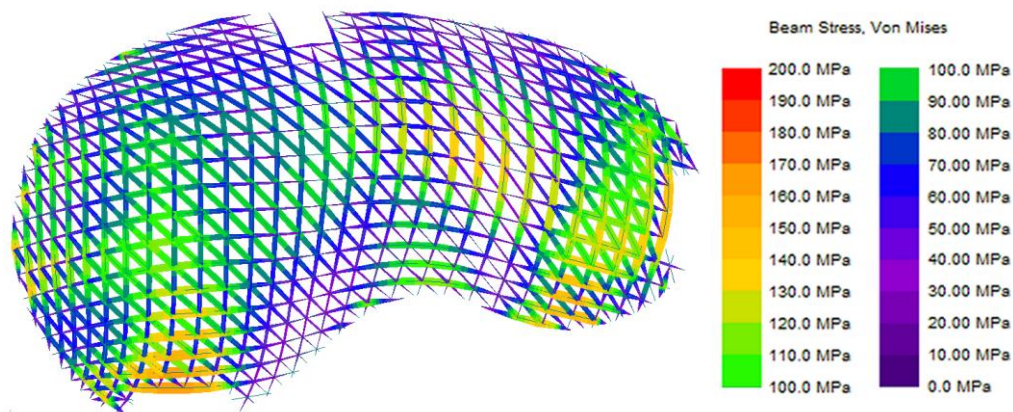

Fig 14. Stress chart on beams resulting from forming only

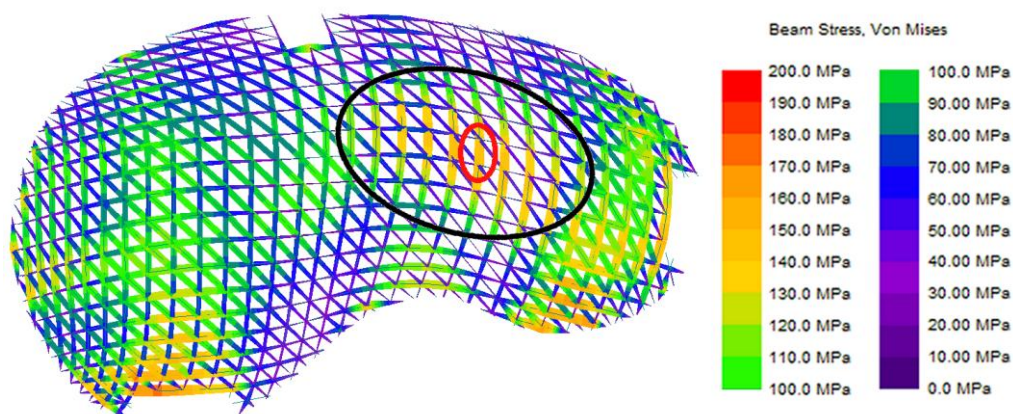

Fig 15. Stress chart on beams resulting from both forming and ULS load

Before breaking the first element one can note that none of the elements is overstressed. The maximal stress reached is $\sigma_{\max} = 167$ MPa.

The way of breaking of a beam has been cautiously experimentally studied in the laboratory and the conclusion is that, when a bended pultruded beam breaks, it loses its bending rigidity but most of the fibres remain unbroken. As a consequence, the beams still have efficiency for traction stress: a knee joint is created (figure 16). Nonetheless, after the joint is used a few times, the fibres eventually break. So, in the simulation, beams are broken when $\beta_j = 1$. For simplicity reason, they are broken in two equal parts and do not participate to the mechanical behaviour anymore.



Fig 16. A knee joint type: experimental break of a beam tested in flexion

So, under the ULS load, the most stressed element is broken to understand how the structure responds. This element is located in the red circle (figure 15). For this element, the stress is equal to 150 MPa. This value has to be compared with its statistically drawn strength: 183 MPa. The safety margin is comfortable since it was shown that the stress slightly depends on the level of load.

After this first break, the structure is still functional as the stress does not seem to have increased. Indeed, it is important to keep in mind that the gridshell is far from buckling. Thus, the break of one element fosters a very little stress redistribution on its neighbours, and does not endanger the gridshell.

So, to continue, another highly stressed element is broken in the same area. Still no global change for the structure is observed. Since nothing has really changed for the gridshell it is decided to double breaks at each step, until something important happens. The only breaking process of the beams is studied. In particular, we have had a few breaks on previous prototypes and we have never observed slips of the connections located near the breaks. Indeed the flexural energy stocked in one element vanishes when it breaks.

After the six first steps, 32 elements (among the 1357 elements of the structure) have been broken and the gridshell is still able to resist to the ULS load. Indeed, in the area of the top of the small dome (area circled in black in the figure 15), the important curvature is along the second direction of beams (direction perpendicular to the main axis of the gridshell). As a consequence, the beams along this direction have more stress and are broken to simulate the accident. Then, the gridshell reacts thanks to the third direction of beams (diagonally beams). These bracing beams undergo the additional load redistributions but, since they were not so bended, they can support extra loading without being overstressed. After the 32 first breaks it is decided to break only 16 elements more in the following step (the 7th). For a comfortable visualisation of the breaks, the broken elements are reported in the figure 18.

After this stage, one beam has a β_j ratio higher than 1. This beam is located near the bottom left door from the top view (figure 17). As a consequence, after these 48 breaks, a beam is going to break without the help of the operator. Depending on the stress redistributions, the breaks might spread or not.

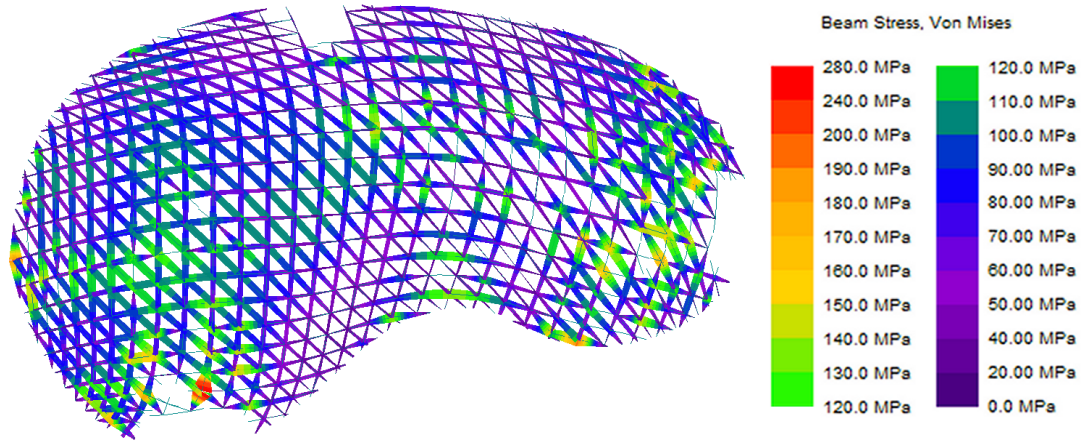

Fig 17. Stress after 48 breaks.

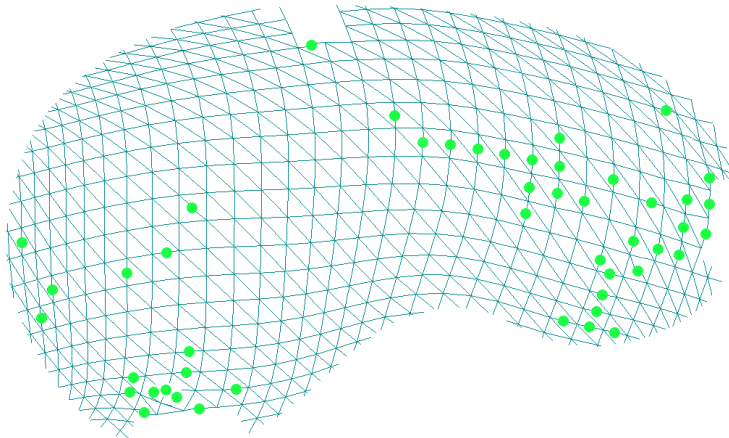

Fig 18. Cartography of the 48 breaks suffered

At this point, the overstressed beam (easily visible in red in the figure 17) is broken. The number of broken elements reaches 49. Actually, this last break makes the stress level in the critic area decrease (redistributions). The level of stress has become low enough to not worry about new self-breaks. And the gridshell can still be exploited. As a conclusion, even if a little part of the gridshell has lost its mechanical properties and original geometry, the all-structure is still resistant and relevant with the prescribed guideline, thanks to its redundancy.

Moreover, the displacements observed are important. The figures 20 and 21 show the evolution of mean \bar{U} and maximal U_{\max} absolute displacements, in millimetres, versus the number of broken elements N .

The maximal displacement U_{\max} is around 400 mm, and the mean value of the displacement \bar{U} is around 20 mm. Given the relative inextensibility of the PVC coated canvas used to cover the gridshell, these displacements would be important enough to create creases on it.

In the case of gridshells, important displacements in the structure are a sign of weakness of the structure. If they are important enough to be detectable, the evacuation can be launched before the structure gets potentially dangerous. The following of the study, based on the continuing of beams' breaking, shows that the gridshell does not become really dangerous and that a total collapse is not expected.

Then the operator breaks 15 new elements. Three important stress concentrations can be observed near the door on the right (figure 19). That means that this part of the structure might now ruin. It is important to note that none of the β_j ratios have reached 1. Consequently, here, the breaks are not spontaneous breaks.

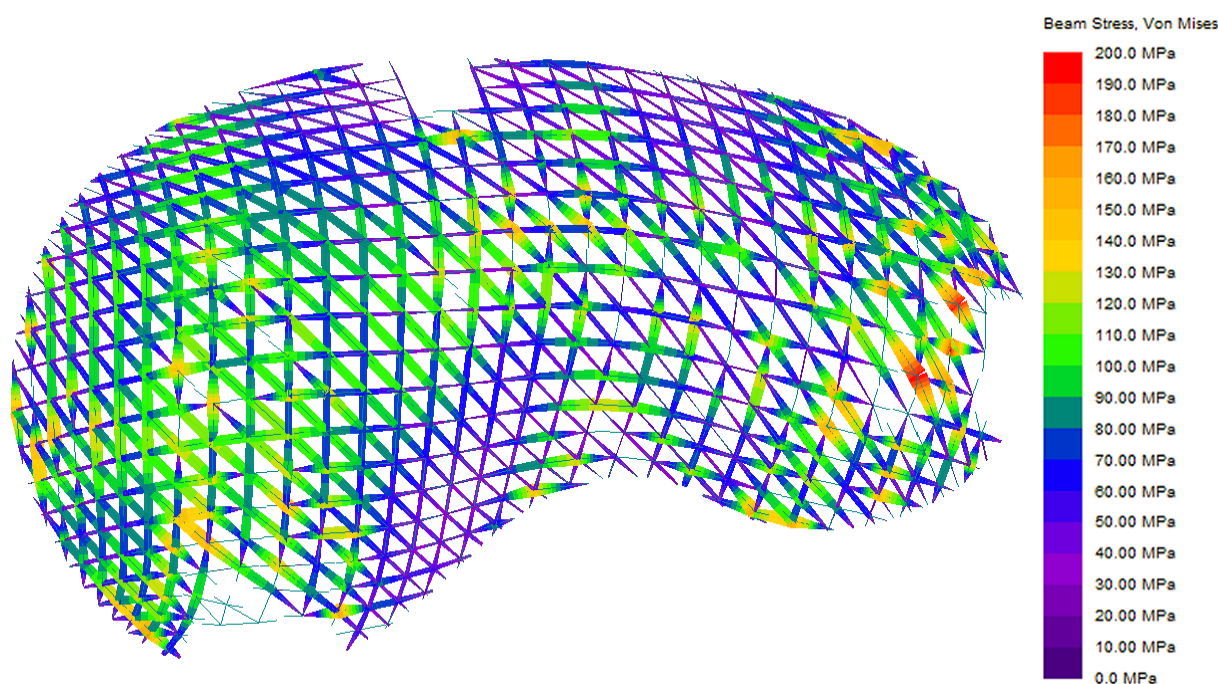

Fig 19. Stress after 64 breaks.

One by one, the elements having the highest β_j ratio are broken. The result is that the stresses naturally decrease to a normal level (typically less than 170 MPa, figure 22). It is due to the fact that when a beam is broken, its load is transferred to the ones nearby through redistributions. That shows that the gridshell is still stable and will not brutally collapse on people.

Once again it is important to check the displacements of the nodes of the structure, to make sure that it is possible to detect such an accidental situation, even visually. On the figures 20 and 21, it is shown that after about 70 breaks, U_{\max} and \bar{U} have respectively increased of about 700 mm and 45 mm. A global perspective view of the gridshell is represented on the figure 22. The two areas affected by local ruin show clearly signs of damage.

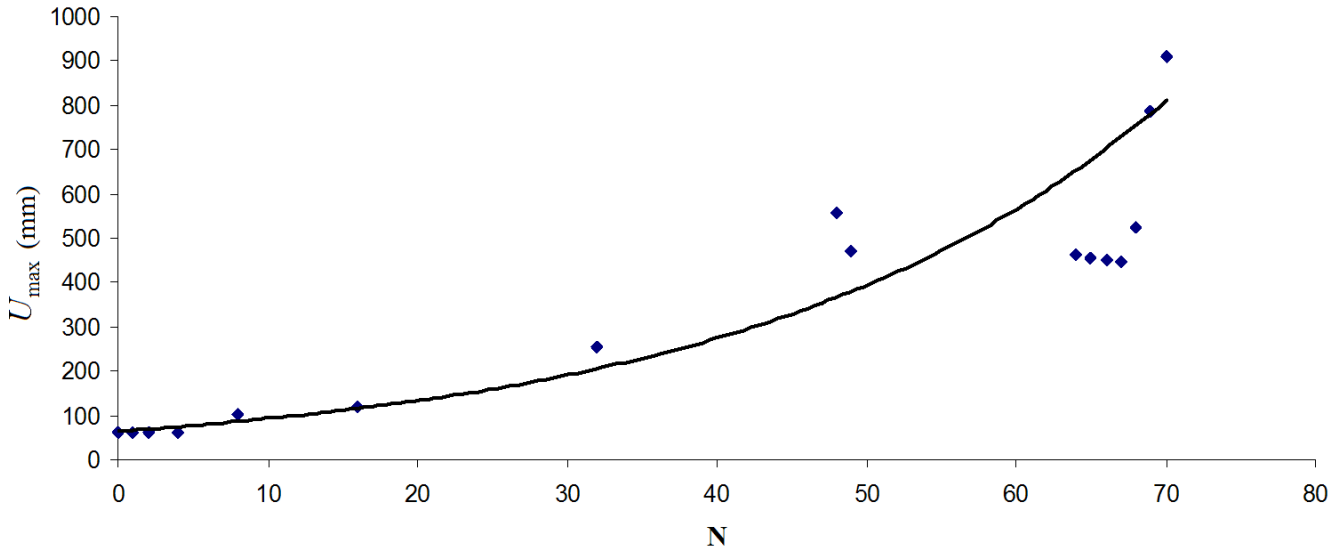

Fig 20. Maximal displacement U_{\max} (mm) versus number of broken elements N

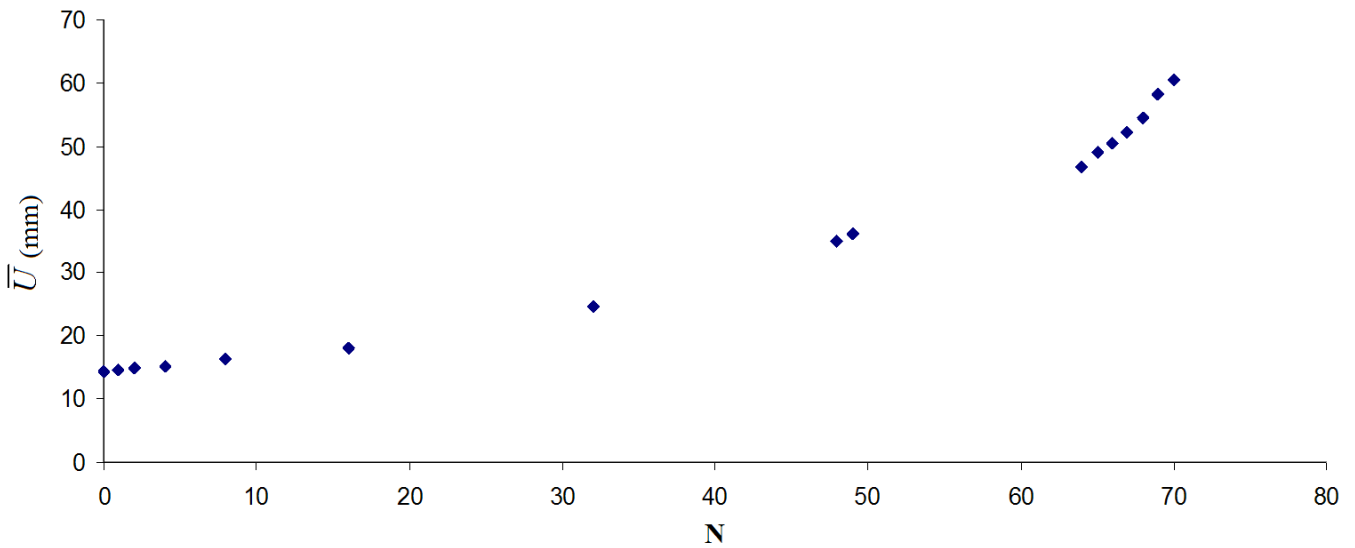

Fig 21. Mean displacement \bar{U} (mm) versus number of broken elements N

Despite these local damages affecting the gridshell, the study demonstrates that the risk of a global collapse of the gridshell is nonexistent at this point, and that the structure remains stable. At this stage, two areas located near doors of the gridshell have been affected by local ruin. These two damaged areas are circled in red in the figure 22. One can conclude that areas located near the doors are weak areas and act as fusible parts of the structure, bringing pseudo-ductility. Since the Solidays' gridshell has been designed with three doors, a third weak area might have an extra ductile behaviour. This third potential source of ductility is circled in orange in the figure 22.

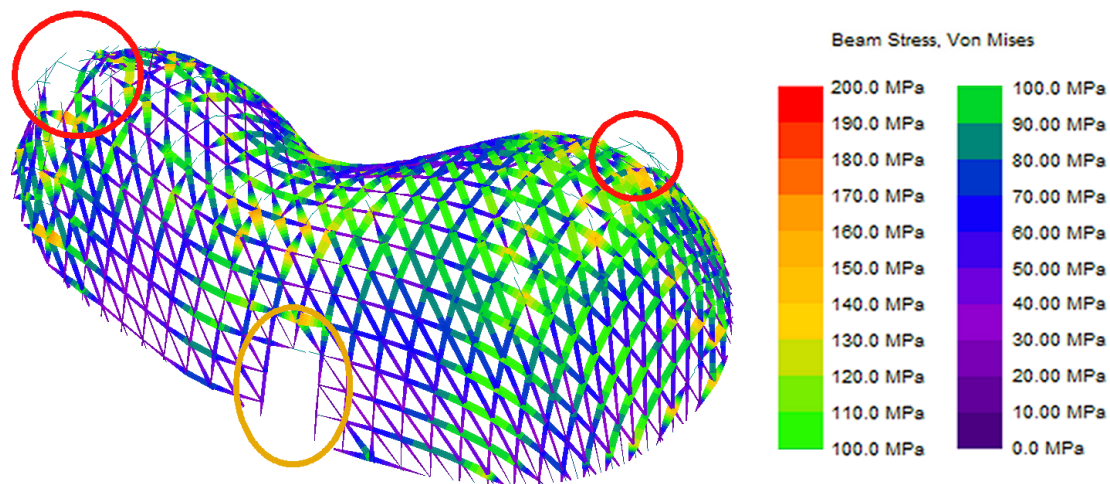

Fig 22. Damage of the structure

At this point it is demonstrated that the structure is still resistant under the ULS case considered. But one might wonder if the structure would resist to the other load cases considered for the design of the gridshell. In particular, the gridshell might not resist to another ULS case, for example for a ULS case with a wind coming from west, south or north. As a verification, it is necessary to apply these loads to make sure the damaged structure will not collapse. After calculations, it is concluded that none of the SLS or ULS loads bring problems.

A case is studied here in detail. This case is the normal case of a dead weights load, that is to say a load of 200 Newton downwards for every node of the gridshell. Large deformations are expected near the two doors where the gridshell partially ruined. The results are shown on the figure 23: the gridshell is far from collapsing. And the displacements are considerable: from the reference, U_{max} is equal to 660 mm, and \bar{U} is equal to 25 mm. Such displacements would be easily visible due to interior fittings and creases of the canvas. It is important to note that the large displacements are concentrated near areas that have already ruined. Nevertheless, at this point, the main part of the gridshell is not affected by the large displacements. To conclude this verification, no other break is expected, even under rough environmental conditions (other ULS cases). As a consequence, the structure of the gridshell is not supposed to collapse, even after the accidental situation studied, and under any of the design loads.

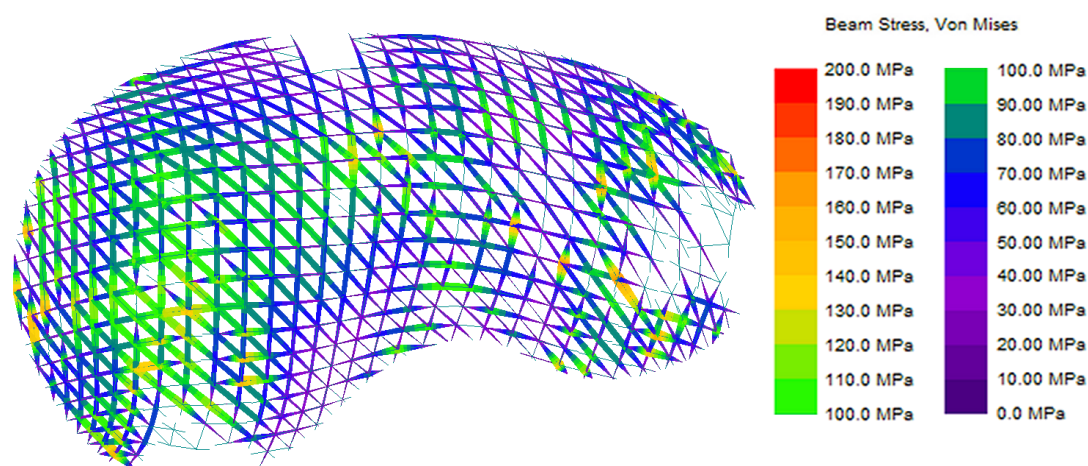

Fig 23. Stress resulting from the dead weight load, after 71 breaks

As a consequence, the gridshell, despite the unfavourable 71 breaks reported in the figure 24, is still far from a global collapse. The reason is that 71 elements represent about 5 % of the total number of elements of the structure (1357). Even if these 71 elements had an important mechanical behaviour, once broken they are assisted by the elements that are still resistant.

It is important to emphasize the fact that a situation with so many breaks is hugely improbable. Indeed, most of the broken elements did not have their ratio β_j higher than 1, at any time of the study. In addition, the accepted strengths take into account the 2.35 safety coefficient. In other words, these many breaks were absolutely improbable. So, the probability of such a situation is very low, except maybe in case of vandalism. Moreover it would be easy to detect such an important number of breaks.

Thus, a pseudo-ductile behaviour of the gridshell has been highlighted. It means, as explained before, that despite the structure is only composed of brittle elements, large displacements may warn people before its collapse. So, the gridshell can safely shelter the people.

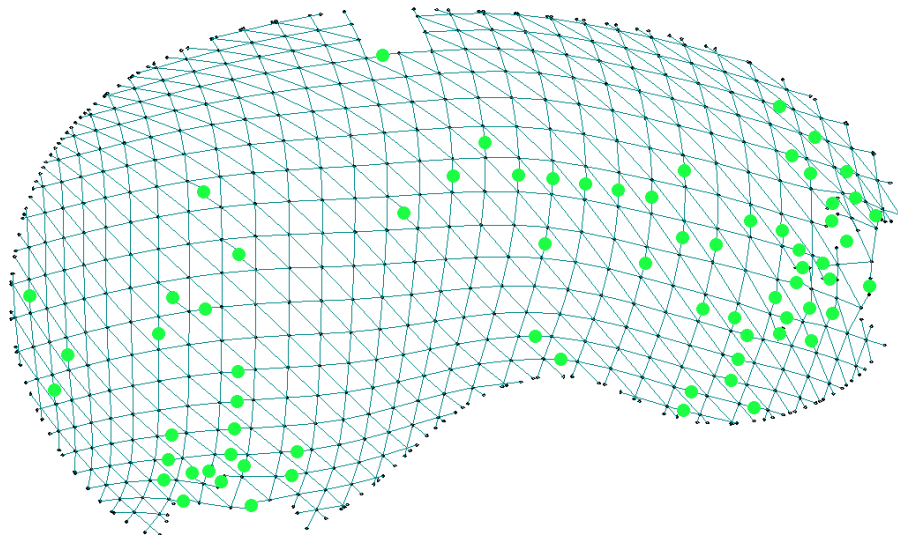

Fig 24. Cartography of the 71 breaks suffered

5. Conclusion

In this paper, it is reminded what is a gridshell within the meaning firstly proposed by Frei Otto during the 70's, and how it is designed. Some information about the building process of the Solidays' gridshell is provided. It is reminded also how composite materials are tailor made for such a structural concept. Experimental mechanical characterization of the GFRP used in this application is detailed and a stochastic description is proposed. It is then demonstrated that the gridshell designed for the Solidays' festival have pseudo-ductile properties. Indeed, it is demonstrated considering Eurocode loading cases (SLS, ULS) that the buckling stands no chance to affect the structure, except in very localized areas, when several elements accidentally break.

So, in the study performed, several beams are broken accidentally, step by step to simulate vandalism, manufacture problems or accidental damage of the beams

(transport). The beams chosen for breaking are the most curved ones (critical case). They are also the most likely to break. Once 49 elements are broken, it appears clearly that a first local area of the gridshell ruins and gives signs of a disorder, thanks to visible large displacements. Then, after 21 new accidental breaks, another local area of the structure ruins without endangering the whole gridshell. At this point two local parts of the gridshell have ruined but its main part remains exploitable and stable. Large visible displacements clearly shown must be enough to start the evacuation of the structure.

During the process of breaking, some “natural” breaks can appear. They are induced by the redistributions of stress. That leads to an overload for a few beams (only one for the study performed). It is important to notice that, for the performed simulations, the natural breaking is followed by a stable behaviour: once the natural cracking is done, stresses decrease to normal level.

After the process of accidental ruin, all the load cases (ELS, ELU) used for the design of the gridshell were applied to the damaged structure to check the residual resistance of the structure. The results are positive since the gridshell is still able to resist to all of the design loads.

In the case studied, and in reference to the classification proposed in [14], the ductility of the gridshell comes from redundancy. When a beam breaks, its stress is transferred to neighbour beams.

To improve the ductile behaviour of the gridshell one might also add brittle fusible elements. For example, replacing a few beams by bigger tubes having the same flexural rigidity could be useful. The big beams would break for lower curvatures [5], without endangering the gridshell thanks to redundancy. Another possibility would be to add thin carbon fibre reinforced polymers components (CFRP components) that cannot undergo as important deformations as GFRP. Thus, if placed in judicious locations, these components would break a bit before the structural beams [19]. But since it has been demonstrated that the gridshell has no reason to collapse without showing many signs of weakness, these improvements are of secondary importance.

6. Acknowledgement:

The authors would like to thank all the people involved in the Solidays’ gridshell project, from the native idea to the achievement of the gridshell which is the result of a fruitful collaboration. Many thanks to the Civil Engineering student team, to the Civil Engineering department of Ecole des Ponts ParisTech, to the Ecole Nationale des Sciences Géographiques for the topographic study of the site, to the firms T/E/S/S and VIRY and also to the support partners: Owens Corning, Ferrari, TopGlass, DSM, Esmerly Caron, as well as the ENSG.

7. References

- [1] Bank LC, Composites for Construction: Structural Design with FRP Materials. Publisher: Wiley, 560 p., 2006, ISBN-10 / ASIN: 0471681261.

- [2] Foret G, Limam O, Numerical and experimental analysis of RC two-way slabs strengthened with NSM CFRP rods. *Construction and Building Materials*, Volume 22, Issue 10, October 2008, pp. 2025-2030
- [3] Shahawy MA, Beitelman T, Arockiasamy M, Sowrirajan R, Experimental investigation on structural repair and strengthening of damaged prestressed concrete slabs utilizing externally bonded carbon laminates. *Composites Part B Engineering* Volume 27, Issue 3-4, 1996, pp. 217-24.
- [4] Grace N, Enomoto T, Abdela-Mohti A, Tokal Y, Flexural behaviour of precast concrete box beams post-tensioned with unbonded, carbon-fiber-composite cables. *PCI Journal*, Volume 53, Issue 4, pp.62-82.
- [5] Baverel O, Caron JF, Tayeb F, Du Peloux L, Gridshells in Composite Materials: Construction of a 300 m2 Forum for the Solidays' Festival in Paris. *Structural Engineering International (IABSE)*, Volume 22, Number 3, August 2012, pp. 408-414.
- [6] Jülich AS, Caron JF, Baverel O, Selfstressed Bowstring Footbridge in FRP. *Composite Structures*, Volume 89, Issue 3, July 2009, pp. 489-496
- [7] Baverel O, Nooshin H, Kuroiwa Y, Configuration processing of nexorades using genetic algorithms. *Journal of the International Association for Shell and Spatial Structures*, Volume 45, Issue 2, 2004, pp. 99-108.
- [8] Douthe C, Baverel O, Caron JF, Gridshell in composite materials: towards wide span shelters. *Journal of the I.A.S.S.*, Volume 48 Issue 155, 2007, pp. 175-180.
- [9] Douthe C, Caron JF, Baverel O, Gridshell structures in glass fibre reinforced polymers. *Construction and Building Materials*, Volume 24, Issue 9, September 2010, pp. 1580-1589
- [10] Otto F, Henniecke J, Matsushita K, Gitterschalen Gridshells. *Institut für Leichte Flächentragwerke*, IL 10, 1974, pp. 340
- [11] Barnes MR, Applications of dynamic relaxation to the topological design and analysis of cable, membrane and pneumatic structures. *Second international conference on space structures*, 1975, pp. 211-219.
- [12] Barnes MR, Form and stress engineering of tension structures. *Structural engineering review*, 1994, Volume 6, Issue 3-4, pp175-202.
- [13] Adriaenssens S, Barnes M, Williams C, A new analytic and numerical basis for the form-finding and analysis of spline and gridshell structures. In: Kumar, B. and Topping, B. H. V., eds. *Computing Developments in Civil and Structural Engineering*. Edinburgh: Civil-Comp Press, 1999, pp. 83-91.
- [14] Keller T, Material-Taylor used of FRP in bridge and building construction. *CIAS International Seminar* 2007.
- [15] Castro J, System ductility and redundancy of FRP structures with ductile adhesively bonded joints. PhD thesis, EPFL 2005.
- [16] Van Erp G.M. Robustness of fibre composite structures loaded in flexure. *FRP Composites in Civil Engineering*, Volume 2, pp 1421-1426.
- [17] Clarke JL, *Structural Design of Polymer Composites*, Eurocomp. Publisher: Taylor&Francis, 1996
- [18] Douthe C, Baverel O, Caron JF, Form-finding of a grid shell in composite materials. *Journal of the International Association for Shell and Spatial structures*. Volume 47, Issue 150, 2006, pp. 53-62.
- [19] Deskovic N, Triantafillou TC, Meier U, Innovative design of FRP combined with concrete – Long-term behavior. *Journal of structural engineering*, Volume 121, 1995, pp 1079-1089.