



**HAL**  
open science

## **Drained Triaxial Tests in Low-Permeability Shales: Application to the Callovo-Oxfordian Claystone**

Malik Belmokhtar, Pierre Delage, Siavash Ghabezloo, Nathalie Conil

### ► **To cite this version:**

Malik Belmokhtar, Pierre Delage, Siavash Ghabezloo, Nathalie Conil. Drained Triaxial Tests in Low-Permeability Shales: Application to the Callovo-Oxfordian Claystone. *Rock Mechanics and Rock Engineering*, 2018, 51 (7), pp.1978-1193. <10.1007/s00603-018-1442-0>. <hal-01741629>

**HAL Id: hal-01741629**

**<https://enpc.hal.science/hal-01741629v1>**

Submitted on 19 Apr 2019

**HAL** is a multi-disciplinary open access archive for the deposit and dissemination of scientific research documents, whether they are published or not. The documents may come from teaching and research institutions in France or abroad, or from public or private research centers.

L'archive ouverte pluridisciplinaire **HAL**, est destinée au dépôt et à la diffusion de documents scientifiques de niveau recherche, publiés ou non, émanant des établissements d'enseignement et de recherche français ou étrangers, des laboratoires publics ou privés.



HAL Authorization

## Drained triaxial tests in low permeability shales. Application to the Callovo-Oxfordian claystone

Malik Belmokhtar<sup>1</sup>, Pierre Delage<sup>1</sup>, Siavash Ghabezloo<sup>1</sup>, Nathalie Conil<sup>2</sup>

<sup>1</sup>Ecole des Ponts ParisTech, Laboratoire Navier/CERMES, 6-8 av. B. Pascal, F77455 Marne la Vallée, France.

<sup>2</sup>Andra, Bure, France.

### **Abstract**

Drained triaxial testing is challenging in low permeability claystones ( $10^{-20} \text{ m}^2$ ). This paper presents a method of testing low permeability clay rocks in a standard triaxial cell. In this system, the resaturation of the specimen and the drainage conditions were enhanced by reducing the drainage length to 19 mm, the specimen radius. To do so, two geotextiles were placed around the top and bottom ends of the specimen, with no connection between them. Resaturation was hence performed by forcing water infiltration into the specimen from the upper and lower geotextiles, with a maximum infiltration length of around 19 mm, resulting in reasonable saturation durations. High precision local measurements of radial strains were also achieved by ensuring direct contact between the LVDT rod and the specimen through the membrane. A poroelastic numerical calculation was carried out, and it was shown that, with these drainage conditions, a strain rate of  $6.6 \times 10^{-8} \text{ s}^{-1}$  was satisfactory to ensure good drainage when shearing claystone specimens. After a check test made on a low permeability sandstone with well-known mechanical characteristics, two tests were carried out to investigate specimens of the Callovo-Oxfordian claystone, a possible host rock for deep geological disposal in France. The results compare well with other published data from drained triaxial tests.

**Keywords:** Triaxial testing, low permeability, claystone, shale, drainage length, strain rate, poroelasticity.

## 1. Introduction

Geological deep formations are considered as possible natural barriers and host formations in the framework of multi-barriers concepts used for long term disposal of high level radioactive wastes. Some European countries selected low permeability and low porosity rocks, according to the geology of the country. In Sweden (in the Aspo Hard Rock Laboratory - HRL) and Switzerland (in the Grimsel Underground research laboratory - URL) diorite and granite formations are considered, respectively, whereas claystones and clays are considered in France, Switzerland and Belgium. In France, the mechanical behaviour of the Callovo-Oxfordian (COx) claystone is investigated in the Bure URL by Andra, the French Agency for the management of radioactive wastes. In Switzerland, the mechanical behaviour of the Opalinus Clay is investigated in the Mont Terri Rock Laboratory managed by SWISSTOPO (Swiss Federal Office of Topography), in collaboration with Nagra (the Swiss Agency for the management of radioactive wastes). In Belgium, the Boom clay is investigated in the Mol URL by the Euridice research organisation.

Besides radioactive waste disposal issues, the investigation of the mechanical behaviour of claystone and shales has also been conducted for various other purposes, including borehole stability for conventional oil and gas production (e.g. *Steiger and Leung 1991, Schmitt et al. 1994, Aoki 1995, Islam and Skalle 2013*), the production of shale oil and gas (e.g. *Ewy et al. 2003, Esemé et al. 2007, Villamor-Lora et al. 2016*), tunnelling issues (e.g. *Einstein 2000, Bonini et al. 2009*), and CO<sub>2</sub> sequestration (*Busch et al. 2008*).

The very low permeability of clays and claystones (in the order of  $10^{-19}$  m<sup>2</sup> for clays and  $10^{-20}$  m<sup>2</sup> for claystones) is an essential feature for the safe confinement of radioactive wastes. However, low permeability results in significant difficulties in the hydro-mechanical testing of claystones. Indeed, fully drained triaxial testing with standard triaxial claystone specimens (height of 76 mm and diameter of 38 mm) requires quite slow loading rates that result in long testing periods. By solving Terzaghi's equation of consolidation, *Gibson and Henkel (1954)* determined appropriate axial strain rates for drained triaxial testing of fine grained soils specimens (see also *Wissa 1969*). As stated in *Bishop and Henkel (1957)*, it is currently accepted that a value of  $1\mu\text{m}/\text{mn}$  ( $2 \times 10^{-7} \text{ s}^{-1}$ ) is appropriate to carry out drained tests on standard triaxial specimens in soils. *Chiu et al. (1983)* extended these concepts to drained triaxial testing on a Melbourne mudstone. Recalling that the combined effects of sampling, storage, preparation and mounting almost certainly caused some loss of moisture in mudstones that are saturated in-situ, they carefully re-saturated the specimens prior to triaxial testing. They

1 found that a strain rate of  $3.3 \times 10^{-7} \text{ s}^{-1}$  was appropriate to ensure satisfactory dissipation of  
2 excess pore pressure during the test. Note however that, with 70% silt sized and 28% clay sized  
3 particles, and a porosity around 25%, the Melbourne mudstone is probably more permeable  
4 than the claystones considered here, that are denser (porosity between 13 and 17%) and have  
5 more than 50% clay fraction. Following *Chiu et al. (1983)*, *Swan et al. (1989)* examined in  
6 detail the strain rate effects in Kimmeridge Bay shale, a shale with a mean permeability of  $8 \times$   
7  $10^{-21} \text{ m}^2$  under 10 MPa. They performed some poroelastic finite elements calculations of pore  
8 pressure generated during triaxial testing and showed that, with a specimen of 50 mm height  
9 and 25 mm in diameter with lateral drainage (drainage length 12.5 mm), an axial strain rate of  
10  $8.3 \times 10^{-7} \text{ s}^{-1}$  was low enough to avoid any pore pressure generation during shear. *Wu et al.*  
11 *(1997)* investigated the behaviour of the Pierre II shale by using the same specimen size as  
12 *Swan et al. (1989)*, with lateral drainage made by fibreglass sidedrains placed around the  
13 specimen. They observed that a rate of  $3 \times 10^{-8} \text{ s}^{-1}$  was sufficient to ensure homogeneous pore  
14 pressure within the specimens during undrained loading. In the same context, *Islam and Skalle*  
15 *(2013)* performed a series of triaxial tests with standard triaxial specimens of Pierre I shale with  
16 strain rates of  $1\text{-}2 \times 10^{-7} \text{ s}^{-1}$  for undrained tests and  $2 \times 10^{-8} \text{ s}^{-1}$  for drained tests.

17  
18  
19  
20  
21  
22  
23  
24  
25  
26  
27  
28  
29  
30  
31  
32  
33  
34  
35  
36  
37  
38  
39  
40  
41  
42  
43  
44  
45  
46  
47  
48  
49  
50  
51  
52  
53  
54  
55  
56  
57  
58  
59  
60  
61  
62  
63  
64  
65  
As stated by *Chiu et al. (1983)*, claystone and shale specimens may be partially saturated  
before testing, due to the successive processes of coring, transport, conservation and trimming  
in the laboratory (see also *Monfared et al., 2011a; Ewy, 2015*). They hence have to be re-  
saturated prior to testing, a process that can be long in low permeability claystones. Resaturation  
is not too difficult in non-swelling mudstone like that tested by *Chiu et al. (1983)*, who put the  
specimens of Melbourne mudstone under vacuum, prior to completely immersing them in de-  
aired water in a desiccator. Things are more complicated in swelling claystones like the COx  
claystone, the Opalinus Clay and the Tournemire shale, with significant swelling occurring  
when putting the specimens in contact with water (*Schmitt et al. 1994*).

Swelling claystones are quite sensitive to changes in water content, as observed by  
*Chiarelli et al. (2003)*, *Valès et al. (2004)*, *Zhang and Rothfuchs (2004)*, *Pham et al. (2007)* and  
*Zhang et al. (2012)*. As mentioned by *Menaceur et al. (2015)*, besides drainage issues, the  
differences in testing procedures with respect to the partially saturated states of the specimens  
are one of the reasons, beside natural variability, of the differences observed in the shear  
strength properties of claystones. Partial saturation and poor drainage may lead to biased  
assessment of the mechanical properties of the tested specimens, over-estimating the shear  
strength with partially saturated specimens, and over-estimating the Young's modulus by

1 running partially drained tests. Furthermore, the long duration of the resaturation process in  
2 standard triaxial tests drained on top and bottom with a drainage length of 38 mm (mid-height  
3 of standard triaxial specimen) makes it difficult to carry out fully drained tests in properly  
4 saturated specimens within a reasonable period of time.  
5  
6

7 In this regard, the hollow cylindrical triaxial apparatus (hollow cylinder specimens of 100  
8 mm external diameter, 60 mm internal diameter and 70 mm height, with drainage ensured on  
9 both the inner and outer faces) developed by *Monfared et al. (2011)* reduced the drainage length  
10 down to half the thickness of the hollow cylinder, say 10 mm. *Hu et al. (2014)* adopted small-  
11 sized triaxial specimens (20 mm in height and diameter) drained on top and bottom, resulting  
12 in a drainage length of 10 mm as well (half the height of the specimen). This small drainage  
13 length, four times smaller than standard triaxial drainage length (38 mm), reduces the pore  
14 pressure diffusion rate by a factor of 16 compared to standard triaxial specimens (*Monfared et*  
15 *al., 2011*). As shown by *Monfared et al. (2011)*, *Mohajerani et al. (2013)*, *Menaceur et al.*  
16 *(2015)* and *Menaceur et al. (2016a)* with hollow cylinder specimen and by *Hu et al. (2014)*  
17 with small-sized specimen, the 10 mm drainage length made it possible to achieve satisfactory  
18 saturation within 3 to 4 days, compared to a period of around one month in standard triaxial  
19 tests. Reasonable results of fully saturated and drained isotropic compression tests have also  
20 been obtained for the COx claystone with a 10 mm high specimen drained at the bottom, also  
21 resulting in a 10 mm drainage length (*Mohajerani et al. 2012; Belmokhtar et al. 2017a, 2017b*).  
22 Based on satisfactorily drained tests, *Belmokhtar et al. (2017a)* determined a set of transverse  
23 isotropic poroelastic parameters of the COx claystone.  
24  
25  
26  
27  
28  
29  
30  
31  
32  
33  
34  
35  
36  
37  
38

39 In this study, a high precision triaxial testing system with enhanced drainage aimed at  
40 testing standard triaxial specimens of low permeability clay rocks (38 mm in diameter and  
41 76 mm in height) is presented. Poroelastic calculations are carried out to determine the relevant  
42 axial strain rate allowing satisfactory drainage, and the system is used to determine the shear  
43 strength properties of the COx claystone.  
44  
45  
46  
47  
48

## 49 **2. Material and methods**

### 50 *The Callovo-Oxfordian claystone*

51 The specimens of the Callovo-Oxfordian claystone tested (core EST51338) were  
52 extracted at a depth of 490 m at the level of the Andra Underground Research Laboratory,  
53 located in Northeast of France near the village of Bure (Figure 1). The COx claystone is a 155  
54 million years old sedimentary rock, with a layer thickness of about 150 m, covered by an  
55  
56  
57  
58  
59  
60  
61  
62  
63  
64  
65

1 Oxfordian limestone layer and deposited upon a Dogger limestone layer. At the depth of  
2 extraction, the COx is composed mostly of clays (45-50%, with 10-24% interstratified  
3 illite/smectite layers, 17-21% illite, 2-3% chlorite) and contains also 28% carbonate, 23%  
4 quartz and 4% of other minerals (Gaucher et al., 2004). The mixed layer illite-smectite fraction  
5 in the clay matrix produces some swelling properties (e.g. Mohajerani et al., 2012; Delage et  
6 al., 2014) and interesting self-sealing capabilities (e.g. Davy et al., 2007; Zhang, 2011;  
7 Menaceur et al. 2015). The clay and carbonate contents of the COx claystone vary with depth,  
8 with total porosity between 14% in carbonated levels and 19.5% in the most argillaceous levels  
9 (Yven et al., 2007) in which the URL has been excavated.

16 The in-situ state of stress in the Bure URL has been investigated in detail by Wileveau et  
17 al. (2007), who estimated a vertical lithostatic total stress  $\sigma_v = 12.7$  MPa, a major horizontal  
18 stress  $\sigma_H = 14.8-16$  MPa, a minor horizontal stress  $\sigma_h = 12.4$  MPa and a hydrostatic pore  
19 pressure  $p_w = 4.9$  MPa. Typical characteristics of the COx claystone are a very low permeability  
20 (in order of  $10^{-20}$  m<sup>2</sup>, Escoffier, 2002; Davy et al., 2007; Zhang, 2011; Menaceur et al., 2015,  
21 2016), a good ability to retain radionuclides and a low diffusion coefficient, resulting in very  
22 slow solute transfer.

29 The two specimens tested in this study (EST51338a and b) come from a 80 mm diameter  
30 core oriented perpendicularly to the horizontal bedding plane of the COx claystone layer at  
31 Bure (see Figure 1). They were trimmed from the core by using a diamond core of 38 mm  
32 diameter, prior to cutting them to the required length (around 76 mm) by using a diamond saw.  
33 The water content was determined on two slices cut on the top and bottom of the specimen by  
34 oven drying at 105°C during 48 hours. The specimen volume was determined by hydrostatic  
35 weighing to calculate the total porosity and the initial degree of saturation.

43 The initial characteristics of the specimen are presented in Table 1. The water content  
44 was 5.97%, corresponding to a degree of saturation of 87.9%, considering a particle density  $\rho_s$   
45 = 2.70 Mg/m<sup>3</sup> (Andra, 2005). A suction measurement was carried out on some the cuttings of  
46 the specimen by using a chilled mirror tensiometer (WP4C, Decagon), providing a value of  
47 36.2 MPa, in good agreement with the water retention curves provided by Pham et al. (2007)  
48 and Wan et al. (2013). These data indicate a slight desaturation of the specimen.

#### 55 *Experimental set-up*

56 A schematic view of the device is shown in Figure 2, together with a photo showing the  
57 specimen wrapped into the upper and lower geotextiles. The device consists of a conventional  
58  
59  
60  
61  
62  
63  
64  
65

1 high pressure triaxial cell, hosting a standard triaxial specimen (38 mm in diameter and 76 mm  
2 in height), and connected to three pressure volume controllers (PVC, GDS Brand). The  
3 confining pressure is applied in the cell through a confining fluid (silicone oil) that is put under  
4 pressure by a PVC (maximum value 64 MPa), whereas 2 other PVCs independently apply the  
5 back pressure through the porous disks placed on the top and bottom of the specimen,  
6 respectively. The pore pressure can be measured by two pressure transducers (PT) connected  
7 to the top and bottom of the specimen, respectively.  
8  
9

10  
11  
12 As also presented in Figure 2, enhanced drainage conditions are ensured by placing two  
13 bands of geotextile on the upper and lower parts of the specimen, with no contact between them.  
14 Both geotextiles are in contact with the corresponding porous stones. The drainage length is  
15 hence reduced to the specimen radius, i.e. 19 mm. The drainage performances of *the* geotextile  
16 under pressure had been checked by *Monfared (2011)*.  
17  
18  
19  
20  
21

22  
23 At mid-height of the specimen, a layer of around 1 cm was left without any geotextile in  
24 contact so as to avoid any connection and water exchange between the upper and lower  
25 geotextiles. Saturation is then possible by forcing the infiltration of water into the specimen  
26 from both geotextiles on top and bottom, allowing specimen resaturation within a short enough  
27 period of time, thanks to the 19 mm maximum infiltration length (if connected, the geotextiles  
28 would have worked as a by-pass between the top and bottom porous stones). This arrangement  
29 also produced direct contact between the specimen and the stems of the four radial LVDTs used  
30 for the local measurement of radial strain. Direct contact was ensured by piercing the (neoprene)  
31 membrane with a hole smaller in diameter than the stem. Fluid tightness was ensured by putting  
32 a drop of neoprene glue on the membrane around the stem. The confining fluid used was a  
33 silicone oil. The effectiveness of the direct contact between the LVDT and the specimen has  
34 been demonstrated in *Belmokhtar et al. (2017a)* and a precision of  $\pm 0.1 \mu\text{m}$  corresponding to a  
35 strain of  $10^{-5}$  was obtained. Two axial LVDTs were supported by a system of rings as shown in  
36 Figure 2b, following the system adopted in *Monfared et al. (2011)*.  
37  
38  
39  
40  
41  
42  
43  
44  
45  
46  
47

48  
49 Figure 3 shows a specimen a specimen mounted with the system supporting the four radial  
50 and two axial LVDTs. The shear strain rate was controlled by using a loading frame with a  
51 capacity of 25 tons. The axial force was directly measured by an immersed force sensor with a  
52 maximum capacity of 25 kN. The cell temperature was controlled at  $25^{\circ}\text{C} \pm 0.1^{\circ}\text{C}$  by a resistive  
53 electric heating belt placed around the cell. The specimen temperature was measured by a  
54 thermocouple placed close to the specimen inside the stainless-steel confining cell. Thermal  
55 isolation was improved by covering the cell with an insulating layer.  
56  
57  
58  
59  
60  
61  
62  
63  
64  
65

### Drained shear rate

Together with the drainage length, the value of the strain rate adopted in triaxial shear tests is of crucial importance with respect to the quality of drainage. Typically, in fine-grained soils, a displacement rate of 1  $\mu\text{m}/\text{min}$  (strain rate of  $2.2 \times 10^{-7} \text{ s}^{-1}$ ) is adopted in standard triaxial specimens (78mm height and 38 mm diameter, permeability  $k$  around  $10^{-18} \text{ m}^2$ ). The drainage length is reduced to 19 mm (specimen radius) by placing filter papers all around the vertical faces of the specimen. Filter papers are connected to specimen ends to accelerate consolidation and pore pressure dissipation (*Gibson and Henkel 1954; Bishop and Henkel 1957*). Based on soil mechanics procedures, *Wu et al. (1997)* adopted a strain rate of  $3 \times 10^{-8} \text{ s}^{-1}$  on a laterally drained 50 mm long specimen of low permeability Pierre II shale to ensure pore pressure homogeneity in an undrained test. The drainage length was  $h = 12.5 \text{ mm}$ . Similarly, *Islam and Skalle (2013)* adopted rates of  $1\text{-}2 \times 10^{-7} \text{ s}^{-1}$  in undrained tests and  $2 \times 10^{-8} \text{ s}^{-1}$  in drained test on Pierre I shale, with a drainage length  $h = 19 \text{ mm}$  (lateral drainage on 38 mm standard triaxial device). These values are to be compared with the values adopted on the COx claystone mentioned above:  $6.5 \times 10^{-6} \text{ s}^{-1}$  by *Zhang and Rothfuchs (2004)* on 40 mm diameter and 80 mm high specimens,  $1.0 \times 10^{-7} \text{ s}^{-1}$  and  $0.9 \times 10^{-7} \text{ s}^{-1}$  by *Hu et al. (2014)* and *Menaceur et al. (2015)*, respectively, with 10 mm drainage length.

Theoretical estimations of the rate ensuring satisfactory drainage in standard triaxial tests were first made by *Gibson and Henkel (1954)* on clays, based on the theory of consolidation. *Monfared et al. (2011a)* carried out some numerical calculations to estimate excess pore pressures in a hollow cylindrical specimen of Opalinus Clay with a drainage length of 10 mm, determining a loading rate of 0.5 kPa/min to ensure satisfactory drained conditions. The same rate was found by *Belmokhtar et al (2017a)* in isotropic compression tests with a 10 mm drainage length.

Based on these results, the excess pore pressure during a shear test was estimated by considering an ideal isotropic linear saturated poroelastic material and by solving the set of coupled hydromechanical equations (1) to (6) by using the finite element method (2D FreeFem++ code, Hecht, 2012).

$$\nabla \cdot \sigma + f = 0 \quad (1)$$

$$\nabla \cdot q_w + \frac{\partial m_w}{\partial t} = 0 \quad (2)$$

$$q_w = -\rho_w \frac{k}{\mu_w} \nabla p_w \quad (3)$$

Eq. (1) is the balance of momentum in which  $\sigma$  is the total stress and  $f$  the gravity forces, that are neglected. Eq. (2) is the water mass conservation in which  $q_w$  is the water flux,  $m_w$  the water mass and  $t$  the time. The water flux is given by Darcy's law in Eq. (3), where  $\rho_w$  is the water density,  $k$  the intrinsic permeability,  $\mu_w$  the water dynamic viscosity and  $p_w$  the pore water pressure.

The stress strain relation is provided in Eq. 4:

$$\underline{d\varepsilon} = \underline{S} (\underline{d\sigma} - b \underline{dp_w}) \quad (4)$$

where  $d\varepsilon$  is the strain tensor,  $d\sigma$  the stress tensor,  $b$  the isotropic Biot coefficient and  $S$  the isotropic linear elastic compliance tensor, defined by the Young's modulus  $E$  and the Poisson coefficient  $\nu$  as follows:

$$\underline{S} = \begin{pmatrix} \frac{1}{E} & \frac{-\nu}{E} & \frac{-\nu}{E} \\ \frac{-\nu}{E} & \frac{1}{E} & \frac{-\nu}{E} \\ \frac{-\nu}{E} & \frac{-\nu}{E} & \frac{1}{E} \end{pmatrix} \quad (5)$$

Within a poroelastic framework (Coussy 2007; Ghabezloo et al. 2008), one can also express the porosity  $\phi$  with respect to the volumetric strain  $\varepsilon_v$ , the Biot Skeleton modulus  $N$  and the pore water pressure  $p_w$  as follows:

$$d\phi = -bd\varepsilon_v + \frac{1}{N} dp_w, \quad \frac{1}{N} = \frac{b-\phi_0}{K_s} \quad (6)$$

The Young's modulus  $E$  and Poisson ratio  $\nu$  of the COx claystone were taken as 4 GPa and 0.3 respectively (Gens et al., 2007), providing a drained bulk modulus  $K_d$  of 3.3 GPa. The unjacketed bulk modulus  $K_s$  was taken as 21.7 GPa (Belmokhtar et al., 2017a), resulting in a Biot coefficient  $b$  of 0.84 (with  $b = 1 - K_d/K_s$ ). An isotropic permeability coefficient  $k = 4 \times 10^{-20} \text{ m}^2$  and a porosity  $\phi = 18\%$  were adopted (Gens et al. 2007; Charlier et al. 2013). The bulk water compression modulus and dynamic viscosity at 25°C were taken  $K_w = 2237 \text{ MPa}$  and  $\mu_w = 8.9 \times 10^{-10} \text{ MPa.s}$ , respectively (Spang, 2002).

The pore pressure calculations were made by using an axisymmetric configuration, with drainage boundary conditions corresponding to the enhanced drainage system (Figure 2), described in more detail in Figure 4a. As seen in the Figure, a water pressure of 4 MPa is applied on the top and upper right lateral face of the specimen, whereas no water transfer is allowed on a small area in the lower lateral face, in a zone where the membrane is in direct contact with

1 the specimen. A comparison is also made by running calculations with drainage only on the top  
2 of the specimen (Figure 4b).

3  
4 Four axial strain rates were considered:  $6.6 \times 10^{-8} \text{ s}^{-1}$  ( $0.3 \text{ } \mu\text{m}/\text{mn}$ ),  $1.1 \times 10^{-7} \text{ s}^{-1}$   
5 ( $0.5 \text{ } \mu\text{m}/\text{mn}$ ),  $2.2 \times 10^{-7} \text{ s}^{-1}$  ( $1 \text{ } \mu\text{m}/\text{mn}$ ) and  $1.1 \times 10^{-6} \text{ s}^{-1}$  ( $5 \text{ } \mu\text{m}/\text{mn}$ ). The effect of the axial strain  
6 rate on the generated excess pore pressure is presented in Figure 5a in the case of enhanced  
7 lateral drainage. The pore pressure profiles are typical of pore pressure dissipation curves  
8 calculated with Terzaghi's consolidation theory, with maximum value at mid height.

9  
10  
11 Unsurprisingly, the lowest excess pore pressure (50 kPa) is obtained at the lowest strain  
12 rate of  $6.6 \times 10^{-8} \text{ s}^{-1}$  ( $0.3 \text{ } \mu\text{m}/\text{mn}$ ), whereas an excess pore pressure of 630 kPa is observed at the  
13 fastest rate of  $1.1 \times 10^{-6} \text{ s}^{-1}$ . The comparison between enhanced and standard drainage conditions  
14 at lowest rate of  $6.6 \times 10^{-8} \text{ s}^{-1}$  (Figure 5b) confirms the efficiency of the lateral drainage.

15  
16  
17 Figure 5c shows the changes in excess pore pressure with respect to the increment of  
18 shear stress  $dq = d(\sigma_1 - \sigma_3)$  where  $\sigma_1$  is the axial stress and  $\sigma_3$  is the (constant) radial one.  
19 Compared to the top and bottom drainage condition where the excess pore pressure reaches a  
20 value of 370 kPa with no stabilisation, stabilisation is more rapidly reached with lateral drainage  
21 at a value of 50 kPa, once  $dq$  reaches 0.6 MPa. 50 kPa is an acceptable value that can be  
22 neglected given the values of peak stress in claystones. Note that this is also true for the value  
23 of 80 kPa obtained at  $1.1 \times 10^{-7} \text{ s}^{-1}$  ( $0.5 \text{ } \mu\text{m}/\text{mn}$ ). Figure 5c also shows that the steady state is  
24 not reached during the first stage of loading at the centre of the specimen with drainage at the  
25 top and bottom only, which can result in a wrong elastic modulus.

26  
27  
28 The satisfactory results obtained with these calculations at a rate of  $6.6 \times 10^{-8} \text{ s}^{-1}$  are  
29 comparable with the values of strain rate adopted in claystones and shales by Wu et al. (1997)  
30 and Islam and Skalle (2013), equal to  $3 \times 10^{-8} \text{ s}^{-1}$  and  $2 \times 10^{-8} \text{ s}^{-1}$ , respectively. They are around  
31 two orders of magnitude smaller than those used by Zhang and Rothfuchs (2004) and Masri et  
32 al. (2014) ( $6.5 \times 10^{-6} \text{ s}^{-1}$  and  $1.0 \times 10^{-6} \text{ s}^{-1}$ , respectively) and approximately correspond to half the  
33 values adopted by Hu et al. (2015) and Menaceur et al. (2016a) on devices with smaller  
34 drainage lengths ( $1.0 \times 10^{-7} \text{ s}^{-1}$  and  $0.9 \times 10^{-7} \text{ s}^{-1}$  with a 10 mm drainage length).

### 3. Experimental results and discussion

#### 3.1. Drained test on Rothbach sandstone

35  
36  
37  
38  
39  
40  
41  
42  
43  
44  
45  
46  
47  
48  
49  
50  
51  
52  
53  
54  
55  
56  
57  
58  
59  
60  
61  
62  
63  
64  
65  
66  
67  
68  
69  
70  
71  
72  
73  
74  
75  
76  
77  
78  
79  
80  
81  
82  
83  
84  
85  
86  
87  
88  
89  
90  
91  
92  
93  
94  
95  
96  
97  
98  
99  
100  
101  
102  
103  
104  
105  
106  
107  
108  
109  
110  
111  
112  
113  
114  
115  
116  
117  
118  
119  
120  
121  
122  
123  
124  
125  
126  
127  
128  
129  
130  
131  
132  
133  
134  
135  
136  
137  
138  
139  
140  
141  
142  
143  
144  
145  
146  
147  
148  
149  
150  
151  
152  
153  
154  
155  
156  
157  
158  
159  
160  
161  
162  
163  
164  
165  
166  
167  
168  
169  
170  
171  
172  
173  
174  
175  
176  
177  
178  
179  
180  
181  
182  
183  
184  
185  
186  
187  
188  
189  
190  
191  
192  
193  
194  
195  
196  
197  
198  
199  
200  
201  
202  
203  
204  
205  
206  
207  
208  
209  
210  
211  
212  
213  
214  
215  
216  
217  
218  
219  
220  
221  
222  
223  
224  
225  
226  
227  
228  
229  
230  
231  
232  
233  
234  
235  
236  
237  
238  
239  
240  
241  
242  
243  
244  
245  
246  
247  
248  
249  
250  
251  
252  
253  
254  
255  
256  
257  
258  
259  
260  
261  
262  
263  
264  
265  
266  
267  
268  
269  
270  
271  
272  
273  
274  
275  
276  
277  
278  
279  
280  
281  
282  
283  
284  
285  
286  
287  
288  
289  
290  
291  
292  
293  
294  
295  
296  
297  
298  
299  
300  
301  
302  
303  
304  
305  
306  
307  
308  
309  
310  
311  
312  
313  
314  
315  
316  
317  
318  
319  
320  
321  
322  
323  
324  
325  
326  
327  
328  
329  
330  
331  
332  
333  
334  
335  
336  
337  
338  
339  
340  
341  
342  
343  
344  
345  
346  
347  
348  
349  
350  
351  
352  
353  
354  
355  
356  
357  
358  
359  
360  
361  
362  
363  
364  
365  
366  
367  
368  
369  
370  
371  
372  
373  
374  
375  
376  
377  
378  
379  
380  
381  
382  
383  
384  
385  
386  
387  
388  
389  
390  
391  
392  
393  
394  
395  
396  
397  
398  
399  
400  
401  
402  
403  
404  
405  
406  
407  
408  
409  
410  
411  
412  
413  
414  
415  
416  
417  
418  
419  
420  
421  
422  
423  
424  
425  
426  
427  
428  
429  
430  
431  
432  
433  
434  
435  
436  
437  
438  
439  
440  
441  
442  
443  
444  
445  
446  
447  
448  
449  
450  
451  
452  
453  
454  
455  
456  
457  
458  
459  
460  
461  
462  
463  
464  
465  
466  
467  
468  
469  
470  
471  
472  
473  
474  
475  
476  
477  
478  
479  
480  
481  
482  
483  
484  
485  
486  
487  
488  
489  
490  
491  
492  
493  
494  
495  
496  
497  
498  
499  
500  
501  
502  
503  
504  
505  
506  
507  
508  
509  
510  
511  
512  
513  
514  
515  
516  
517  
518  
519  
520  
521  
522  
523  
524  
525  
526  
527  
528  
529  
530  
531  
532  
533  
534  
535  
536  
537  
538  
539  
540  
541  
542  
543  
544  
545  
546  
547  
548  
549  
550  
551  
552  
553  
554  
555  
556  
557  
558  
559  
560  
561  
562  
563  
564  
565  
566  
567  
568  
569  
570  
571  
572  
573  
574  
575  
576  
577  
578  
579  
580  
581  
582  
583  
584  
585  
586  
587  
588  
589  
590  
591  
592  
593  
594  
595  
596  
597  
598  
599  
600  
601  
602  
603  
604  
605  
606  
607  
608  
609  
610  
611  
612  
613  
614  
615  
616  
617  
618  
619  
620  
621  
622  
623  
624  
625  
626  
627  
628  
629  
630  
631  
632  
633  
634  
635  
636  
637  
638  
639  
640  
641  
642  
643  
644  
645  
646  
647  
648  
649  
650  
651  
652  
653  
654  
655  
656  
657  
658  
659  
660  
661  
662  
663  
664  
665  
666  
667  
668  
669  
670  
671  
672  
673  
674  
675  
676  
677  
678  
679  
680  
681  
682  
683  
684  
685  
686  
687  
688  
689  
690  
691  
692  
693  
694  
695  
696  
697  
698  
699  
700  
701  
702  
703  
704  
705  
706  
707  
708  
709  
710  
711  
712  
713  
714  
715  
716  
717  
718  
719  
720  
721  
722  
723  
724  
725  
726  
727  
728  
729  
730  
731  
732  
733  
734  
735  
736  
737  
738  
739  
740  
741  
742  
743  
744  
745  
746  
747  
748  
749  
750  
751  
752  
753  
754  
755  
756  
757  
758  
759  
760  
761  
762  
763  
764  
765  
766  
767  
768  
769  
770  
771  
772  
773  
774  
775  
776  
777  
778  
779  
780  
781  
782  
783  
784  
785  
786  
787  
788  
789  
790  
791  
792  
793  
794  
795  
796  
797  
798  
799  
800  
801  
802  
803  
804  
805  
806  
807  
808  
809  
810  
811  
812  
813  
814  
815  
816  
817  
818  
819  
820  
821  
822  
823  
824  
825  
826  
827  
828  
829  
830  
831  
832  
833  
834  
835  
836  
837  
838  
839  
840  
841  
842  
843  
844  
845  
846  
847  
848  
849  
850  
851  
852  
853  
854  
855  
856  
857  
858  
859  
860  
861  
862  
863  
864  
865  
866  
867  
868  
869  
870  
871  
872  
873  
874  
875  
876  
877  
878  
879  
880  
881  
882  
883  
884  
885  
886  
887  
888  
889  
890  
891  
892  
893  
894  
895  
896  
897  
898  
899  
900  
901  
902  
903  
904  
905  
906  
907  
908  
909  
910  
911  
912  
913  
914  
915  
916  
917  
918  
919  
920  
921  
922  
923  
924  
925  
926  
927  
928  
929  
930  
931  
932  
933  
934  
935  
936  
937  
938  
939  
940  
941  
942  
943  
944  
945  
946  
947  
948  
949  
950  
951  
952  
953  
954  
955  
956  
957  
958  
959  
960  
961  
962  
963  
964  
965  
966  
967  
968  
969  
970  
971  
972  
973  
974  
975  
976  
977  
978  
979  
980  
981  
982  
983  
984  
985  
986  
987  
988  
989  
990  
991  
992  
993  
994  
995  
996  
997  
998  
999  
1000

1  
2  
3  
4  
5  
6  
7  
8  
9  
10  
11  
12  
13  
14  
15  
16  
17  
18  
19  
20  
21  
22  
23  
24  
25  
26  
27  
28  
29  
30  
31  
32  
33  
34  
35  
36  
37  
38  
39  
40  
41  
42  
43  
44  
45  
46  
47  
48  
49  
50  
51  
52  
53  
54  
55  
56  
57  
58  
59  
60  
61  
62  
63  
64  
65

composed of 85% quartz, 12% feldspars and 3% clays, with a porosity of 16% (*Ghabezloo and Sulem, 2009*) and a permeability of  $5 \times 10^{-13} \text{ m}^2$  (*Ferfera 2001*). *Ghabezloo and Sulem (2009, 2010)* determined the unjacketed modulus of the Rothbach sandstone (41.6 GPa) and saw a significant stress dependency of its drained bulk modulus, that increased from 2 to 10 GPa when the effective confining stress was increased from 2 to 13 MPa. The Skempton  $B$  coefficient decreased from 0.75 to 0.55 for an effective confining pressure increase from 1.5 to 5 MPa. Over the same range of pressure, the undrained bulk modulus increased from about 8 to 16 GPa.

Given that, in this work, the isotropic compression test was run by injecting confining fluid in the cell, it was found easier to control a confinement loading rate rather than a strain loading rate. Assuming a mean drained bulk modulus of about 5 GPa (see *Ghabezloo and Sulem, 2009*), one can estimate the volumetric strain rate at about  $1.6 \times 10^{-7} \text{ s}^{-1}$ , corresponding to a value of  $5.5 \times 10^{-8} \text{ s}^{-1}$  for both radial and axial strain rates. Various loading-unloading drained cycles were performed by cycling the confining stress between 2 MPa and 15 MPa with a constant pore pressure of 1 MPa.

The results obtained are plotted together with that of *Ghabezloo and Sulem (2009)* in Figure 6. The close values of radial and axial strains measured demonstrate the isotropic nature of the sandstone. The volumetric response during the loading phase appears to be quite comparable to that provided by *Ghabezloo and Sulem (2009)*, confirming the stress dependent feature and the non-linearity of the drained bulk modulus of the Rothbach sandstone. This good correspondence provides good confidence in the quality of the strains measurements.

### 3.2. Saturation of the COx claystone specimens

As mentioned in the introduction, the COx claystone is very sensitive to changes in water content and partially saturated states are known to provide higher Young's modulus and strength (*Zhang and Rothfuchs 2004; Pham et al. 2007, Menaceur et al. 2015*). As commented above, the specimens trimmed from the cores in the laboratory were not fully saturated. To properly test the mechanical behaviour of low permeability geo-materials, particular attention should be devoted to the resaturation procedure prior to mechanical testing. Following *Monfared et al. (2011a)* on the Opalinus clay and *Mohajerani et al. (2011), Menaceur et al. (2015; 2016a)* and *Belmokhtar et al. (2017a)* on the COx claystone, saturation was performed under stress conditions close to in-situ ones in an attempt to minimize swelling. To do so, any contact of the specimen with water was avoided by keeping the circuits and the porous elements (geotextile and porous stones) dry during the specimen setup. Then, the specimen surrounded

1  
2  
3  
4  
5  
6  
7  
8  
9  
10  
11  
12  
13  
14  
15  
16  
17  
18  
19  
20  
21  
22  
23  
24  
25  
26  
27  
28  
29  
30  
31  
32  
33  
34  
35  
36  
37  
38  
39  
40  
41  
42  
43  
44  
45  
46  
47  
48  
49  
50  
51  
52  
53  
54  
55  
56  
57  
58  
59  
60  
61  
62  
63  
64  
65

by geotextile (Figure 3a) was placed on the base, the membrane was placed and the LVDTs fixed to the specimen. The cell was then placed and filled with the confining fluid (oil). Vacuum was applied through the valve located close to the pressure transducer (PT) so as to evacuate any trapped air between the membrane and the specimen while maintaining closed the valves situated between water PVCs and the cell ducts. The confining stress was increased to 8 MPa, a value close to the value of the in-situ Terzaghi mean effective stress  $\sigma'$  ( $\sigma' = \sigma - p_w$ ) estimated by Wileveau et al. (2007). The drainage system under vacuum was then filled with de-aired water through the PT valves while the PVC valves were kept closed, ensuring good saturation of the drainage system in a first stage, and of the specimen in a second stage. Note that the desaturation of the claystone ( $S_r = 87.9\%$ ) from the initial saturated state resulted in a slight increase in salinity, that was compensated by the specimen resaturation with demineralized water. Finally, the confining stress and pore pressure were simultaneously increased up to 12 MPa and 4 MPa, respectively, at a rate of 100 kPa/min, to reach stress conditions close to in-situ. The use of high back pressure is also recommended to ensure air bubbles dissolution in pore fluid when saturating low permeability shales (Wu et al., 1997).

Figure 7 shows the monitored radial local strain  $\varepsilon_2$  (parallel to bedding) and axial local strain  $\varepsilon_1$  (perpendicular to bedding) together with the volumetric strain ( $\varepsilon_v = \varepsilon_1 + 2\varepsilon_2$ ). A clear anisotropy is observed, with axial swelling larger than the radial one in both specimens. The measured strains stabilize after a period of 8 days in specimen EST51338a and 10 days in specimen EST51338b. The monitored volumetric swelling strains is about 0.97% in specimen EST51338a and 0.85% in specimen EST51338b, comparable to the volumetric strain (1.11%) measured by *Menaceur et al. (2015)*. Unfortunately, no comparison could be made with the volume changes calculated from the water absorbed by the specimen through the back-pressure PVCs, because of a leak that occurred somewhere in the connecting lines between the specimen and the PVCs. As observed in Figure 7, the water exchange curves are linear in both cases, with no final stabilisation, unlike the local strain measurements.

Because of this leak, no determination of the Skempton  $B$  parameter could be made by increasing the confining stress, since the pore pressure measurement was affected by the leak in the back-pressure circuit. Note however that *Mohajerani et al. (2011)* and *Belmokhtar et al. (2017)* obtained, on the same claystone under the same stress conditions ( $\sigma = 12$  MPa and  $p_w = 4$  MPa), a Skempton coefficient ( $B = 0.84$ ) corresponding to full saturation, with a 10 mm drainage length, in tests in which the stabilisation of volume changes occurred after 3 days. So,

1  
2  
3  
4  
5  
6  
7  
8  
9  
10  
11  
12  
13  
14  
15  
16  
17  
18  
19  
20  
21  
22  
23  
24  
25  
26  
27  
28  
29  
30  
31  
32  
33  
34  
35  
36  
37  
38  
39  
40  
41  
42  
43  
44  
45  
46  
47  
48  
49  
50  
51  
52  
53  
54  
55  
56  
57  
58  
59  
60  
61  
62  
63  
64  
65

it is considered that the stabilisation reached here after 15 days with a drainage length of 19 mm should also correspond to full saturation.

### 3.3. Shear tests

Two shear tests were conducted on specimens EST51338a and EST51338b along two different loadings paths (Figure 8) at a temperature of 25°C. Both specimens were saturated under a Terzaghi effective stress  $\sigma'$  close to the in-situ effective stress ( $\sigma' = 8$  MPa,  $\sigma_3 = 12$  MPa,  $p_w = 4$  MPa). Specimen EST51338a was sheared under in-situ effective stress, and specimen EST51338b was sheared at 1.5 in-situ effective stress ( $\sigma' = 12$  MPa,  $\sigma_3 = 16$  MPa,  $p_w = 4$  MPa). The increase in confining stress until 16 MPa in test EST51338b was carried out with a loading rate of 0.5 kPa/min, small enough ensure drained conditions (Monfared et al., 2011a; Menaceur et al., 2015; Belmokhtar et al., 2017a).

The drained shear tests were carried out under constant confining stress with a strain rate of  $6.6 \times 10^{-8} \text{ s}^{-1}$  (0.3  $\mu\text{m}/\text{min}$ ) to ensure satisfactory drainage conditions. The axial strength was measured with both internal and external force gauges, that provided similar responses.

The shear tests results are presented in Figure 9 in terms of radial, axial and volumetric strain changes with respect to the differential stress ( $q_d = \sigma_1 - \sigma_3$ ) for the two confining stresses. The stress-strain curves are typical of claystones, with similar contraction-dilation in both cases. For specimen EST51338a under stress conditions close to in-situ, the transition from contraction to dilation is observed at a differential stress of 14.4 MPa and the peak is reached at  $q_d = 18,2$  MPa, at 1.28% axial and  $-0.67\%$  radial strain ( $-0.06\%$  volumetric strain). The same occurs for test EST51338b under 12 MPa confining stress, with a transition from contraction to dilation at  $q_d = 17$  MPa prior to reaching peak at  $q_d = 22,2$  MPa, at 1.32% axial and  $-0.73\%$  radial strain ( $-0.14\%$  volumetric strain). In both cases, the externally measured axial strain is higher than the local one, confirming the interest of local measurements.

The post-peak response is governed by the creation of a shear plane with an inclination of about  $65^\circ$  with respect to horizontal, as shown in Figure 10. These results are comparable to other ones obtained in claystones by Naumann et al. (2007), Zhang et al. (2007), Hu et al. (2014) and Menaceur et al. (2015). As expected, the mechanical response is stress dependent with higher shear strength at higher confining stress, giving a value of stress at peak equal to 18 MPa at 8 MPa effective confining stress and 22 MPa at 12 MPa effective confining stress.

The values of shear strength are plotted together in a  $q$ - $p'$  diagram together with the results of Hu et al. (2014) on small specimens and Menaceur et al. (2015) in the hollow cylinder

apparatus (Figure 11). Given that the numerical calculations conducted by *Monfared et al. (2011)* showed that the strain rate ( $0.9 \times 10^{-7} \text{ s}^{-1}$ ) adopted by *Menaceur et al. (2015)* with a drainage length of 10 mm in the hollow cylinder apparatus ensured good drainage conditions, and given that *Hu et al. (2014)* adopted a comparable strain rate ( $1 \times 10^{-7} \text{ s}^{-1}$ ) with the same drainage length, all data correspond to drained conditions. One observes a good overall comparability of the drained shear strength data obtained on various devices, with parallel curves that provide the same value of friction angle of  $21^\circ$ . Shear strength values are also well related with respect to the specimen's porosities, with the largest strength at lower porosity of 13% (Hu et al. 2014, Menaceur et al. 2015) and smallest one at the highest porosity of 17% (Menaceur et al. 2015).

The shear stress/axial strain curves of Figure 9 allow one to determine some elastic parameters at various Terzaghi effective stresses ( $\sigma'$ ). The strain-stress relationship for a transversely isotropic material in drained conditions is given by *Detournay and Cheng (1993)* as follows:

$$\begin{pmatrix} d\varepsilon_1 \\ d\varepsilon_2 \\ d\varepsilon_3 \end{pmatrix} = \begin{pmatrix} \frac{1}{E_1} & \frac{-\nu_{12}}{E_1} & \frac{-\nu_{12}}{E_1} \\ \frac{-\nu_{12}}{E_1} & \frac{1}{E_2} & \frac{-\nu_{23}}{E_2} \\ \frac{-\nu_{12}}{E_1} & \frac{-\nu_{23}}{E_2} & \frac{1}{E_2} \end{pmatrix} \begin{pmatrix} d\sigma_1 \\ d\sigma_2 \\ d\sigma_3 \end{pmatrix} \quad (7)$$

where,  $E_1$  is the Young's modulus in the direction  $x_1$  perpendicular to bedding plane,  $E_2$  the Young's modulus in the direction  $x_2$  parallel to bedding plane,  $\nu_{12}$  and  $\nu_{23}$  are the Poisson ratios in the  $(x_1, x_2)$  and  $(x_2, x_3)$  planes, respectively. In a case of drained shearing test with constant radial stress, the measurement of axial and radial strains allows one to determine the Young's modulus  $E_1$  and the Poisson's ratio  $\nu_{12}$  using the following relations:

$$\frac{d\varepsilon_1}{d\sigma_1} = \frac{1}{E_1} \quad (8)$$

$$\frac{d\varepsilon_2}{d\sigma_1} = \frac{-\nu_{12}}{E_1} \quad (9)$$

A Young's secant modulus  $E_1 = 2.9 \text{ GPa}$  is obtained from the data of Figure 9a at 0.1% axial strain under a Terzaghi effective stress close to in-situ ( $\sigma' = 8 \text{ MPa}$ ), with a  $\nu_{12}$  Poisson's ratio of 0.22. Under a 12 MPa Terzaghi effective stress, a larger Young's modulus

1  
2  
3  
4  
5  
6  
7  
8  
9  
10  
11  
12  
13  
14  
15  
16  
17  
18  
19  
20  
21  
22  
23  
24  
25  
26  
27  
28  
29  
30  
31  
32  
33  
34  
35  
36  
37  
38  
39  
40  
41  
42  
43  
44  
45  
46  
47  
48  
49  
50  
51  
52  
53  
54  
55  
56  
57  
58  
59  
60  
61  
62  
63  
64  
65  
 $E_1$  of 4.2 GPa is obtained with a Poisson's ratio  $\nu_{12} = 0.14$ . These parameters are summarized in Table 2.

The Young's moduli obtained with a porosity of 16% are in good agreement with that obtained by *Menaceur et al. (2015)* with a porosity of 17%, confirming also the rate of increase in  $E_1$  with effective stress (Figure 12a). The Young's modulus obtained by *Menaceur et al. (2015)* at 8 MPa Terzaghi effective stress at a porosity of 13% is slightly higher than that obtained in this study. The agreement between both data sets is however not observed in terms of change in Poisson's ratio with stress (Figure 12b), with a decrease obtained here compared with the increase observed by *Menaceur et al. (2015)*. Note however that the measurement of the Poisson's ratio is rather difficult because of the small range of the measured radial strains and of the uncertainties in measurements.

These data confirm that, provided that a sufficiently low axial strain rate is adopted, the drained triaxial system developed with standard triaxial specimens (38 mm diameter and 76 mm height) in this work provides on low permeability shales comparable results than other enhanced drained triaxial devices.

The mechanical properties of the COx claystone presented here, together with those of *Hu et al. (2014)* and *Menaceur et al. (2016a)*, were all obtained after resaturating the specimens under stress. Whereas *Hu et al. (2014)* imposed a confining stress of 2 MPa and a pore pressure of 1 MPa, *Menaceur et al. (2016a)* performed their resaturation under larger stress (9 MPa confining stress, 1 MPa pore pressure), close to the in-situ value of the Terzaghi effective stress. The same effective stress was adopted here, with a confining stress of 12 MPa and a pore pressure of 4 MPa, closer to in-situ stress conditions. In all cases, some swelling of the specimens, generally close to 1 %, was observed during the resaturation procedure. Such swelling could perhaps result in some damage and an underestimation of the mechanical characteristics of the specimens, given that swelling occurs through the developments of micro-cracks (*Wan et al. 2013, Wang et al. 2013, Menaceur et al. 2016b*). Indeed, the values obtained here are smaller than those provided by *Andra (2005)* and *Armand et al. (2016)*, in which an average value of the Young modulus of 6 GPa is considered as representative of the clayey layer at the level of the Bure URL. Similarly, the failure criterion presented in *Armand et al. (2016)* is reasonably parallel to the criterion of Figure 11, but with larger stresses at failure, with an intersection with the  $q$  axis comprised between 12 and 20 MPa. Note that the tests reported in *Armand et al. (2016)* have been conducted at an axial strain rate of  $10^{-6} \text{ s}^{-1}$  on standard triaxial specimens previously equilibrated under a relative humidity of 90% (suction

1  
2  
3  
4  
5  
6  
7  
8  
9  
10  
11  
12  
13  
14  
15  
16  
17  
18  
19  
20  
21  
22  
23  
24  
25  
26  
27  
28  
29  
30  
31  
32  
33  
34  
35  
36  
37  
38  
39  
40  
41  
42  
43  
44  
45  
46  
47  
48  
49  
50  
51  
52  
53  
54  
55  
56  
57  
58  
59  
60  
61  
62  
63  
64  
65

13.1 MPa). This resulted in a water content of 6% and a degree of saturation estimated around 95%, based on existing data on the retention properties of the COx claystone (*Wan et al. 2013*). The combined effects of these testing conditions on the failure stress obtained should then be further investigated, given that partial saturation and high axial strain rate could also have some effects on the measured mechanical parameters. Of course, the best way to determine a representative set of parameters could be to avoid the resaturation procedure by testing fully saturated specimens, and all the possible ways of minimising desaturation during coring, storage and specimen trimming should be looked for prior testing the specimens in the laboratory.

#### 4. Conclusion

To cope with the difficulty of running drained triaxial tests in low permeability claystones and shales, a drainage system enhanced by using upper and lower geotextiles placed around a standard triaxial specimen, and respectively connected to the upper and lower porous stones was developed. Besides reducing the drainage length to the specimen radius (19 mm), the system produced satisfactory resaturation thanks to the absence of a connection between the geotextiles, forcing water infiltration (connected geotextiles would have worked as a by-pass between the top and bottom porous stones). High precision in radial strain measurements were made possible by ensuring direct contact between the LVDT stems and the specimen through the membrane.

Particular attention was paid to the saturation phase that has been conducted under high confining and back pressures to avoid any possible damage and to ensure full dissolution of air bubbles into the pore water.

An isotropic compression validation test was carried out on a Rothbach sandstone providing a volumetric response comparable to *Ghabezloo and Sulem (2009)*, providing good confidence in the quality of the strain measurements.

Finally, based on a poroelastic coupled calculation, the axial strain rates necessary to ensure full drainage conditions was estimated. A strain rate of  $6.6 \times 10^{-8} \text{ s}^{-1}$  was adopted and two shear tests were conducted on specimens of the COx claystone under in-situ effective stress condition ( $\sigma = 12 \text{ MPa}$ ,  $p_w = 4 \text{ MPa}$ ) and 1.5 in-situ effective stress condition ( $\sigma = 16 \text{ MPa}$ ,  $p_w = 4 \text{ MPa}$ ). The peak shear stresses obtained are located along a failure line reasonably parallel to the failure envelope previously obtained by *Hu et al. (2014)* and *Menaceur et al. (2015)*. The envelope obtained corresponds to smaller shear strength values compared to what

1  
2  
3  
4  
5  
6  
7  
8  
9  
10  
11  
12  
13  
14  
15  
16  
17  
18  
19  
20  
21  
22  
23  
24  
25  
26  
27  
28  
29  
30  
31  
32  
33  
34  
35  
36  
37  
38  
39  
40  
41  
42  
43  
44  
45  
46  
47  
48  
49  
50  
51  
52  
53  
54  
55  
56  
57  
58  
59  
60  
61  
62  
63  
64  
65

are considered to be the characteristic values of the COx claystone (*Andra 2005, Armand et al. 2016*). This could be due to possible under-estimation of the parameters that result from the 1% swelling observed during the saturation phase under stress. Conversely, the effects of testing specimens previously submitted to a controlled relative humidity that result in an almost saturated state should also be further considered.

Compared to other methods of triaxial testing with reduced drainage length, the device developed here has the advantage to be easier to use compared to the hollow cylinder developed by *Monfared et al. (2011)*. Compared to the small specimens tested by *Hu et al. (2014)*, the use of standard triaxial specimens allows for having high precision local measurements of axial and radial strains, made possible here by ensuring direct contact of the LVDT rods with the specimen. This capability is of great importance with respect to the determination of the elastic parameters that requires the measurement of small strains along reversible stress paths.

**Acknowledgements**

The authors are indebted to Andra, the French agency for the management of radioactive wastes, for funding this work, providing the claystone specimens and for fruitful discussions. The work was also supported by Ecole des ponts ParisTech, in the framework of the PhD thesis of the first author. The detailed examination and fruitful suggestions by the Co-editor and the anonymous Reviewer also helped for significantly improving this contribution.

## References

- 1  
2 Andra (2005) Synthesis argile: evaluation of the feasibility of a geological repository in  
3 argillaceous formation.  
4  
5  
6 Aoki T, Tan CP, Cox RHT, Bamford WE (1995) Determination of anisotropic poroelastic  
7 parameters of a transversely isotropic shale by means of consolidated undrained triaxial  
8 tests. Proc. 8th Int. Cong. Rock Mech. T. Jujii Ed, Tokyo, Japan, 2, 172-176.  
9  
10  
11 Belmokhtar M, Delage P, Ghabezloo S, Menaceur H, Tang AM, Conil N (2017a) Poroelasticity  
12 of the Callovo–Oxfordian Claystone. Rock Mech Rock Eng 50:871–889. doi:  
13 10.1007/s00603-016-1137-3  
14  
15  
16 Belmokhtar M, Delage P, Ghabezloo S, Conil N (2017b) Thermal Volume Changes and Creep  
17 in the Callovo-Oxfordian Claystone. Rock Mech Rock Eng. doi: 10.1007/s00603-017-  
18 1238-7  
19  
20  
21 Bishop AW, Henkel DJ (1957) The measurement of soil properties in the triaxial test. Edward  
22 Arnold (Publishers) LTD, London  
23  
24  
25 Bonini M, Debernardi D, Barla M, Barla G (2009) The Mechanical Behaviour of Clay Shales  
26 and implications on the Design of Tunnels. Rock Mech Rock Eng 42(2): 361-388.  
27  
28  
29 Busch A, Alles S, Gensterblum Y, Prinz D, Dewhurst D, Raven M, et al. (2008) Carbon dioxide  
30 storage potential of shales. Int J. Greenh Gas Control 2(3):297–308.  
31  
32  
33 Charlier R, Collin F, Pardoën B, Talandier J, Radu JP, Gerard P (2013) An unsaturated hydro-  
34 mechanical modelling of two in-situ experiments in Callovo-Oxfordian argillite. Eng Geol  
35 165:46–63.  
36  
37  
38 Chiarelli AS (2000) Étude expérimentale et modélisation du comportement mécanique de  
39 l'argilite de l'est. PhD thesis, Université Lille I.  
40  
41  
42 Chiarelli AS, Shao JF, Hoteit N (2003) Modeling of elastoplastic damage behavior of a  
43 claystone. Int J Plast 19:23–45.  
44  
45  
46 Chiu HK, Johnston IW, Donald IB (1983) Appropriate Techniques for Triaxial Testing of  
47 Saturated Soft Rock. Int J Rock Mech Mining Sc & Geomech Abst 20(3):107-120  
48  
49  
50 Coussy O (2007) Revisiting the constitutive equations of unsaturated porous solids using a  
51 Lagrangian saturation concept. 1675–1694.  
52  
53  
54 Davy CA, Skoczylas F, Barnichon J-D, Lebon P (2007) Permeability of macro-cracked argillite  
55  
56  
57  
58  
59  
60  
61  
62  
63  
64  
65

under confinement: Gas and water testing. *Phys Chem Earth, Parts A/B/C* 32:667–680.

1  
2 Delage P, Cui YJ, Tang a M (2010) Clays in radioactive waste disposal. *J Rock Mech Geotech*  
3  
4 *Eng* 2:111–123. doi: 10.3724/SP.J.1235.2010.00111  
5

6 Delage P, Menaceur H, Tang A-M, Talandier J (2014) Suction effects in deep Callovo-  
7  
8 Oxfordian claystone Suction effects in deep Callovo-Oxfordian claystone. *Géotechnique*  
9  
10 *Lett* 4:267–271.  
11

12 Detournay E, Cheng AH (1993) Fundamentals of Poroelasticity. Chapter 5 Compr *Rock Eng*  
13  
14 *Princ Pract Proj Vol II, Anal Des Method*, ed C Fairhurst, Pergamon Press II:113–171.  
15

16 Einstein HH (2000) Tunnels in Opalinus Clayshale: A Review of Case Histories and New  
17  
18 Developments. *Tunnelling and underground space technology* 15(1): 13-29.  
19

20 Escoffier S (2002) Caractérisation expérimentale du comportement hydromécanique des  
21  
22 argilites de Meuse Haute-Marne. PhD thesis, Institut National Polytechnique de Lorraine.  
23

24 Esemé E, Urai JL, Krooss BM, Littke R (2007) Review of mechanical properties of oil shales:  
25  
26 implications for exploitation and basin modelling. *Oil Shale* 24(2):159–174  
27

28 Ewy RT, Stankovich RJ, Bovberg CA (2003) Mechanical Behavior of Some Clays and Shales  
29  
30 from 200m to 3800m Depth. In: Culligan P, Einstein H, Whittle A (eds) *Soil and Rock*  
31  
32 *America 2003: Proc. 12<sup>th</sup> PanAm Conf Soil Mech Geotech Eng and 39<sup>th</sup> US Rock Mech*  
33  
34 *Symp.* Verlag Glückauf, Essen, 445-452.  
35

36 Ewy RT (2015) Shale/claystone response to air and liquid exposure, and implications for  
37  
38 handling, sampling and testing. *Int J Rock Mech Min Sci* 80:388–401.  
39

40 Ferfera FMR (2001) Mécanismes physiques de l'évolution de la perméabilité d'un grès sous  
41  
42 chargements simulant la déplétion d'un gisement. *Oil Gas Sci Technol* 56:347–355. doi:  
43  
44 10.2516/ogst:2001030  
45

46 Gaucher E, Robelin C, Matray JM, Négrel G, Gros Y, Heitz JF, Vinsot A, Rebours H,  
47  
48 Cassagnabère A, Bouchet A (2004) ANDRA underground research laboratory:  
49  
50 Interpretation of the mineralogical and geochemical data acquired in the Callovian-  
51  
52 Oxfordian formation by investigative drilling. *Phys Chem Earth* 29:55–77.  
53

54 Gens A, Vaunat J, Garitte B, Wileveau Y (2007) In situ behaviour of a stiff layered clay subject  
55  
56 to thermal loading : observations and interpretation. *Géotechnique* 57:207–228.  
57

58 Ghabezloo S, Sulem J, Guédon S, Martineau F, Saint-Marc J (2008) Poromechanical behaviour  
59  
60  
61  
62  
63  
64  
65

- of hardened cement paste under isotropic loading. *Cem Concr Res* 38:1424–1437.
- 1  
2  
3  
4  
5  
6  
7  
8  
9  
10  
11  
12  
13  
14  
15  
16  
17  
18  
19  
20  
21  
22  
23  
24  
25  
26  
27  
28  
29  
30  
31  
32  
33  
34  
35  
36  
37  
38  
39  
40  
41  
42  
43  
44  
45  
46  
47  
48  
49  
50  
51  
52  
53  
54  
55  
56  
57  
58  
59  
60  
61  
62  
63  
64  
65
- Ghabezloo S, Sulem J (2009) Stress dependent thermal pressurization of a fluid-saturated rock. *Rock Mech Rock Eng* 42:1–24.
- Ghabezloo S, Sulem J (2010) Effect of the volume of the drainage system on the measurement of undrained thermo-poro-elastic parameters, *Int. J. Rock Mech. Min. Sci.*, 47, 60–68.
- Gibson RE, Henkel DJ (1954) Influence of Duration of tests at Constant Rate of Strain on Measured “Drained” Strength. *Géotechnique* 4:6–15.
- Hecht F (2012) New development in freefem+. *J Numer Math* 20:251–265. doi: 10.1515/jnum-2012-0013
- Hu DW, Zhang F, Shao JF (2014) Experimental study of poromechanical behavior of saturated claystone under triaxial compression. *Acta Geotech* 9:207–214.
- Islam MA, Skalle P (2013) An experimental investigation of shale mechanical properties through drained and undrained test mechanisms. *Rock Mech Rock Eng* 46:1391–1413. doi: 10.1007/s00603-013-0377-8
- Masri M, Sibai M, Shao JF, Mainguy M (2014) Experimental investigation of the effect of temperature on the mechanical behavior of Tournemire shale. *Int J Rock Mech Min Sci* 70:185–191.
- Menaceur H, Delage P, Tang A-M, Conil N (2015) The thermo-mechanical behaviour of the Callovo-Oxfordian claystone. *Int J Rock Mech Min Sci* 78:290–303.
- Menaceur H, Delage P, Tang A-M, Conil N (2016a) On the Thermo-Hydro-Mechanical Behaviour of a Sheared Callovo-Oxfordian Claystone Specimen with Respect to the EDZ Behaviour. *Rock Mech Rock Eng* 49:1875–1888.
- Menaceur H., Delage P., Tang A.M. and Talandier J. 2016b. The status of water in swelling shales: an insight from the water retention properties of the Callovo-Oxfordian claystone. *Rock Mech Rock Eng* 49 (12), 4571- 4586
- Mohajerani M, Delage P, Monfared M, Tang A-M, Sulem J, Gatmiri B (2011) Oedometric compression and swelling behaviour of the Callovo-Oxfordian argillite. *Int J Rock Mech Min Sci* 48:606–615.
- Mohajerani M, Delage P, Sulem J, Monfared M, Tang A-M, Gatmiri B (2013) The Thermal Volume Changes of the Callovo–Oxfordian Claystone. *Rock Mech Rock Eng* 47:131–

142.

- 1  
2 Mohajerani M, Delage P, Sulem J, Monfared M, Tang A-M, Gatmiri B (2012) A laboratory  
3 investigation of thermally induced pore pressures in the Callovo-Oxfordian claystone. *Int*  
4 *J Rock Mech Min Sci* 52:112–121.  
5  
6  
7  
8 Monfared M (2011) *Couplages température-endommagement-perméabilité dans les sols et*  
9 *roches argileux*. PhD thesis, Université Paris-Est.  
10  
11  
12 Monfared M, Delage P, Sulem J, Mohajerani M, Tang A-M, De Laure E (2011a) A new hollow  
13 cylinder triaxial cell to study the behavior of geo-materials with low permeability. *Int J*  
14 *Rock Mech Min Sci* 48:637–649.  
15  
16  
17  
18 Monfared M, Sulem J, Delage P, Mohajerani M (2011b) A Laboratory Investigation on Thermal  
19 Properties of the Opalinus Claystone. *Rock Mech Rock Eng* 44:735–747. doi:  
20 10.1007/s00603-011-0171-4  
21  
22  
23  
24 Naumann M, Hunsche U, Schulze O (2007) Experimental investigations on anisotropy in  
25 dilatancy, failure and creep of Opalinus Clay. *Phys Chem Earth* 32:889–895. doi:  
26 10.1016/j.pce.2005.04.006  
27  
28  
29  
30 Pham QT, Vales F, Malinsky L, Nguyen M-D, Gharbi H (2007) Effects of desaturation–  
31 resaturation on mudstone. *Phys Chem Earth, Parts A/B/C* 32:646–655.  
32  
33  
34 Schmitt L, Forsans T, Santarelli FJ (1994) Shale Testing and Capillary Phenomena, *Int J Rock*  
35 *Mech Mining Sc & Geomech Abst*, 31(5): 411-427.  
36  
37  
38 Steiger RR, Leung RK 1991. Consolidated undrained triaxial test procedure for shales. *Rock*  
39 *mechanics as a Multidisciplinary Science*, Proc. 32nd U.S. Syrup., JC Roegiers Ed: 637-  
40 646.  
41  
42  
43  
44 Spang B (2002) Excel add-in for properties of water and steam in SIunits.  
45 <http://www.cheresources.com/iapwsif97.shtml>.  
46  
47  
48  
49 Swan G, Cook J, Bruce S, Meehan R (1989) Strain rate effects in Kimmeridge bay shale. *Int.*  
50 *J. Rock Mech. Min. Sci. & Geomech. Abstr*, 26(2): 135-149.  
51  
52  
53 Valès F, Nguyen Minh D, Gharbi H, Rejeb A (2004) Experimental study of the influence of the  
54 degree of saturation on physical and mechanical properties in Tournemire shale (France).  
55 *Appl Clay Sci* 26:197–207.  
56  
57  
58  
59 Villamor-Lora R, Ghazanfari E, Asanza Izquierdo E (2016) Geomechanical Characterization  
60  
61  
62  
63  
64  
65

of Marcellus Shale. *Rock Mech Rock Eng*, 49(9), 3403–3424.

1  
2 Wan M, Delage P, Tang A-M, Talandier J (2013) Water retention properties of the Callovo-  
3 Oxfordian claystone. *Int J Rock Mech Min Sci* 64:96–104.  
4

5  
6 Wang L, Bornert M, Chanchole S (2013) Micro-scale experimental investigation of  
7 deformation and damage of argillaceous rocks under hydric and mechanical loads.  
8 *Poromechanics V ASCE* 1635–43.  
9

10  
11  
12 Wileveau Y, Cornet FH, Desroches J, Blumling P (2007) Complete in situ stress determination  
13 in an argillite sedimentary formation. *Phys Chem Earth* 32:866–878. doi:  
14 <https://doi.org/10.1016/j.pce.2006.03.018>  
15  
16

17  
18 Wissa AEZ (1969) Pore pressure measurement in saturated stiff soils. *J. Soil Mech. Fdns Div.*  
19 *Am. Soc. civ. Engrs* 95:SM4, 1063-1073.  
20

21  
22 Wu B, Tan CP, Aoki T (1997) Specially designed techniques for conducting consolidated  
23 undrained triaxial tests on low permeability shales. *Int J Rock Mech Min Sci* 34:336.e1-  
24 336.e14. doi: 10.1016/S1365-1609(97)00168-8  
25  
26

27  
28 Yven B, Sammartino S, Geraud Y, Homand F, Villieras F (2007) Mineralogy, texture and  
29 porosity of Callovo-Oxfordian argillites of the Meuse/Haute-Marne region (eastern Paris  
30 Basin). *Mémoires la société Géologique Fr* 0249–7546:73–90.  
31  
32

33  
34 Zhang CL (2011) Experimental evidence for self-sealing of fractures in claystone. *Phys Chem*  
35 *Earth* 36:1972–1980.  
36  
37

38  
39 Zhang CL, Rothfuchs T (2004) Experimental study of the hydro-mechanical behaviour of the  
40 Callovo-Oxfordian argillite. *Appl Clay Sci* 26:325–336.  
41

42  
43 Zhang CL, Rothfuchs T, Su K, Hoteit N (2007) Experimental study of the thermo-hydro-  
44 mechanical behaviour of indurated clays. *Phys Chem Earth, Parts A/B/C* 32:957–965.  
45  
46

47  
48 Zhang F, Xie SY, Hu DW, Gatmiri B (2012) Effect of water content and structural anisotropy  
49 on mechanical property of claystone. *Appl Clay Sci* 69:79–86.  
50  
51

## List of Tables

Table 1. Initial characteristics of the tested specimens.

Table 2. Strength and elastic parameters of the tested specimens of COx claystone

## List of Figures

Figure 1. Geological map showing the location of the Bure underground research laboratory (also called Meuse-Haute Marne URL), located in the eastern area of the Paris sedimentary basin, at the boundary between two French departments, the Meuse and the Haute Marne departments. The layer of Callovo-Oxfordian claystone is located between two layers of limestone, at a depth of around 500 m.

Figure 2. a) Overall schematic view of the specimen mounted with the 3 PVC connected: two PVCs are independently connected to the upper and lower geotextiles, respectively, whereas the third one is connected to the confining fluid (silicon oil) in the cell, so as to apply the confining stress; b) Photo of the specimen wrapped into the upper and lower geotextiles. Each geotextile is connected to the porous disks, placed on top and bottom of the specimen, respectively.

Figure 3. a) Local strain measurements device. Four radial LVDTs are fixed on a ring surrounding the specimen. Two axial LVDTs provide the changes in distance between two other rings tightly fixed on the specimen; b) Detail of the direct contact between the LVDT stem and the specimen through the neoprene membrane, with two bolts screwed on the stem on both sides of the membrane. Fluid tightness is ensured by a drop of neoprene glue put around the stem.

Figure 4. Initial and boundary conditions applied on a quarter upper right specimen in axisymmetric conditions: a) Enhanced drainage is made possible thanks to both the top porous disk and the lateral geotextile connected to it; b) Simple drainage by the top porous disk only.

Figure 5. a) Calculated excess pore pressure profiles at steady state at different strain rates with enhanced lateral drainage, showing satisfactory drainage at strain rates of  $6.6 \times 10^{-8}$  and  $1.1 \times 10^{-7} \text{ s}^{-1}$ ; b) Comparison between simple and enhanced lateral drainage at a rate of  $6.6 \times 10^{-8} \text{ s}^{-1}$ ; c) Pore pressure changes at the centre of the sample at a rate of  $6.6 \times 10^{-8} \text{ s}^{-1}$ , showing no stabilisation in pore pressure with simple drainage.

1  
2  
3  
4  
5  
6  
7  
8  
9  
10  
11  
12  
13  
14  
15  
16  
17  
18  
19  
20  
21  
22  
23  
24  
25  
26  
27  
28  
29  
30  
31  
32  
33  
34  
35  
36  
37  
38  
39  
40  
41  
42  
43  
44  
45  
46  
47  
48  
49  
50  
51  
52  
53  
54  
55  
56  
57  
58  
59  
60  
61  
62  
63  
64  
65

Figure 6. Drained isotropic compression test carried out on Rothbach sandstone (porosity  $\phi = 16\%$ , permeability  $k = 5 \times 10^{-3} \text{ m}^2$ ), showing good comparability with the data of Ghabezloo and Sulem (2009).

Figure 7. Saturation phase: (a) EST51338a, (b) EST51338b. The volume changes could not be derived from the water volume absorbed by the specimen and monitored by the back-pressure PVCs, because of leaks in the back-pressure circuit, that resulted in having linear water exchanges in both cases.

Figure 8. Stress paths followed, with constant confining stress: a) Test on specimen EST51338a, submitted to an initial Terzaghi effective stress of 8 MPa, close to in-situ stress conditions; b) Test on specimen EST51338b, at 1.5 time the mean Terzaghi effective stress (12 MPa).

Figure 9. Stress strain curves of the drained sheared tests. Externally measured axial strains are in both cases larger than local ones. Similar contraction-dilation is observed in both cases, with a negative volumetric strain at peak (slight expansion); a) Specimen EST51338a under initial conditions close to in-situ mean effective stress (8 MPa); b) Specimen EST51338b under around 1.5 in-situ mean effective stress (12 MPa).

Figure 10. Sheared specimen (EST51338b), with shear plane inclined at an angle of  $65^\circ$  from horizontal.

Figure 11. Comparison of the shear envelopes determined in this work (porosity 16%) with data of shear tests determined with different devices on saturated specimens of the Callovo-Oxfordian claystone, with porosities between 12 and 17%: Menaceur et al. (2015) on hollow cylinder specimens; Hu et al. (2014) on small size triaxial specimens, either drained or undrained. Both devices had same drainage length (10 mm) with strain rates of  $0.9 \times 10^{-7} \text{ s}^{-1}$  and  $1.0 \times 10^{-7} \text{ s}^{-1}$ , respectively. Shear envelopes are well organised with respect to the porosity.

Figure 12. Comparison of the elastic parameters determined in this work with those of Menaceur et al. (2015): a) Young's modulus, with good comparability between tests and a linear increase with the confining stress; b) Poisson's ratio, with poor comparability, probably due to the difficulties in accurately measuring this parameter due to the very small radial strains mobilised.

1  
2  
3  
4  
5  
6  
7  
8  
9  
10  
11  
12  
13  
14  
15  
16  
17  
18  
19  
20  
21  
22  
23  
24  
25  
26  
27  
28  
29  
30  
31  
32  
33  
34  
35  
36  
37  
38  
39  
40  
41  
42  
43  
44  
45  
46  
47  
48  
49  
50  
51  
52  
53  
54  
55  
56  
57  
58  
59  
60  
61  
62  
63  
64  
65

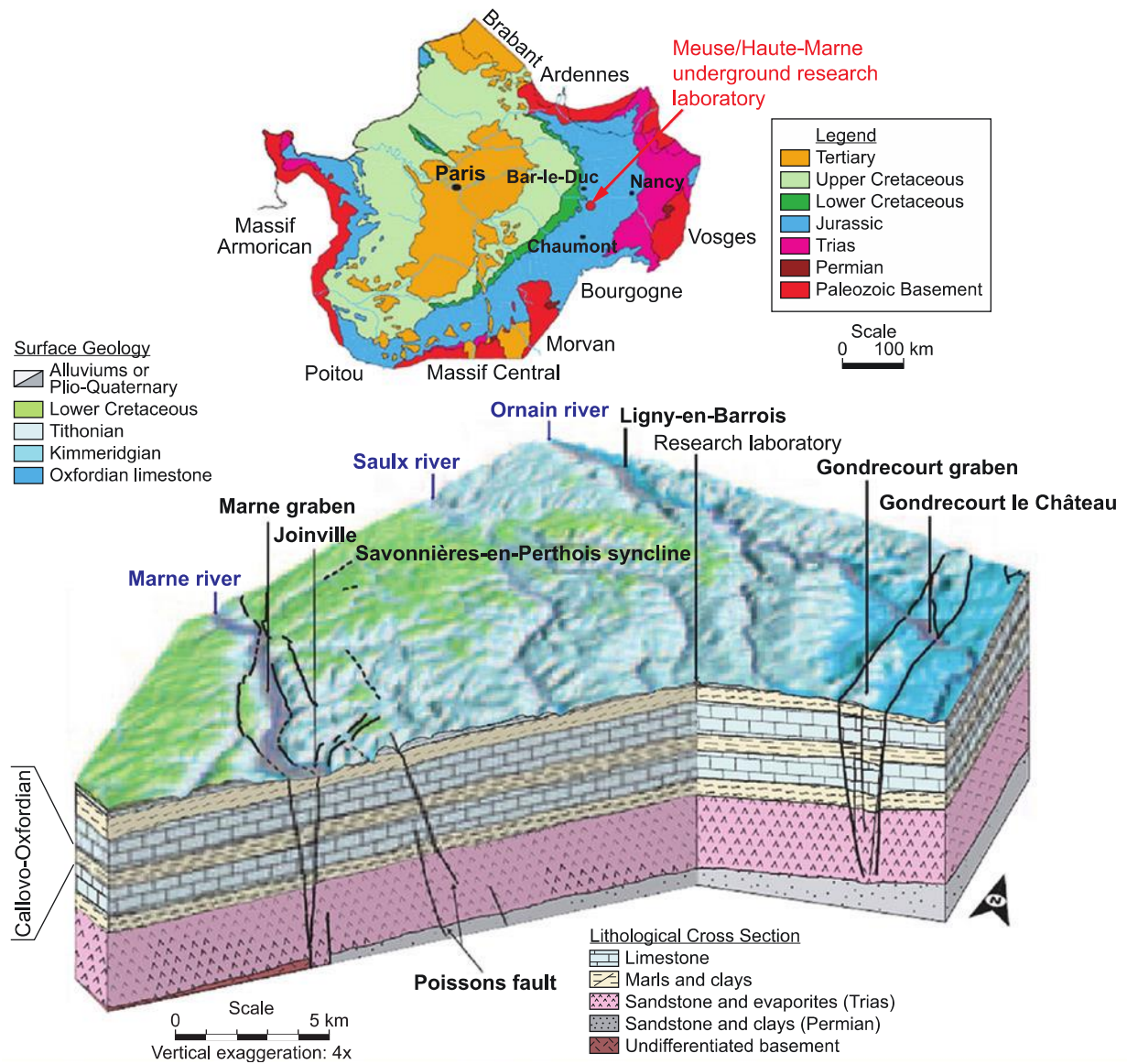

Figure 1. Geological map showing the location of the Bure underground research laboratory (also called Meuse-Haute Marne URL), located in the eastern area of the Paris sedimentary basin, at the boundary between two French departments, the Meuse and the Haute Marne departments. The layer of Callovo-Oxfordian claystone is located between two layers of limestone, at a depth of around 500 m (ANDRA 2005).

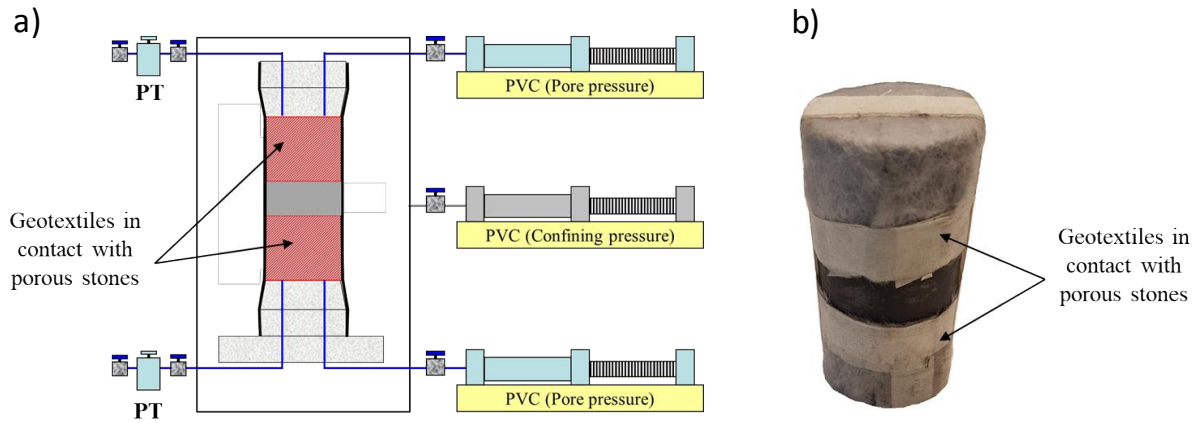

Figure 2. a) Overall schematic view of the specimen mounted with the 3 PVC connected: two PVCs are independently connected to the upper and lower geotextiles, respectively, whereas the third one is connected to the confining fluid (silicon oil) in the cell, so as to apply the confining stress; b) Photo of the specimen wrapped into the upper and lower geotextiles. Each geotextile is connected to the porous disks, placed on top and bottom of the specimen, respectively.

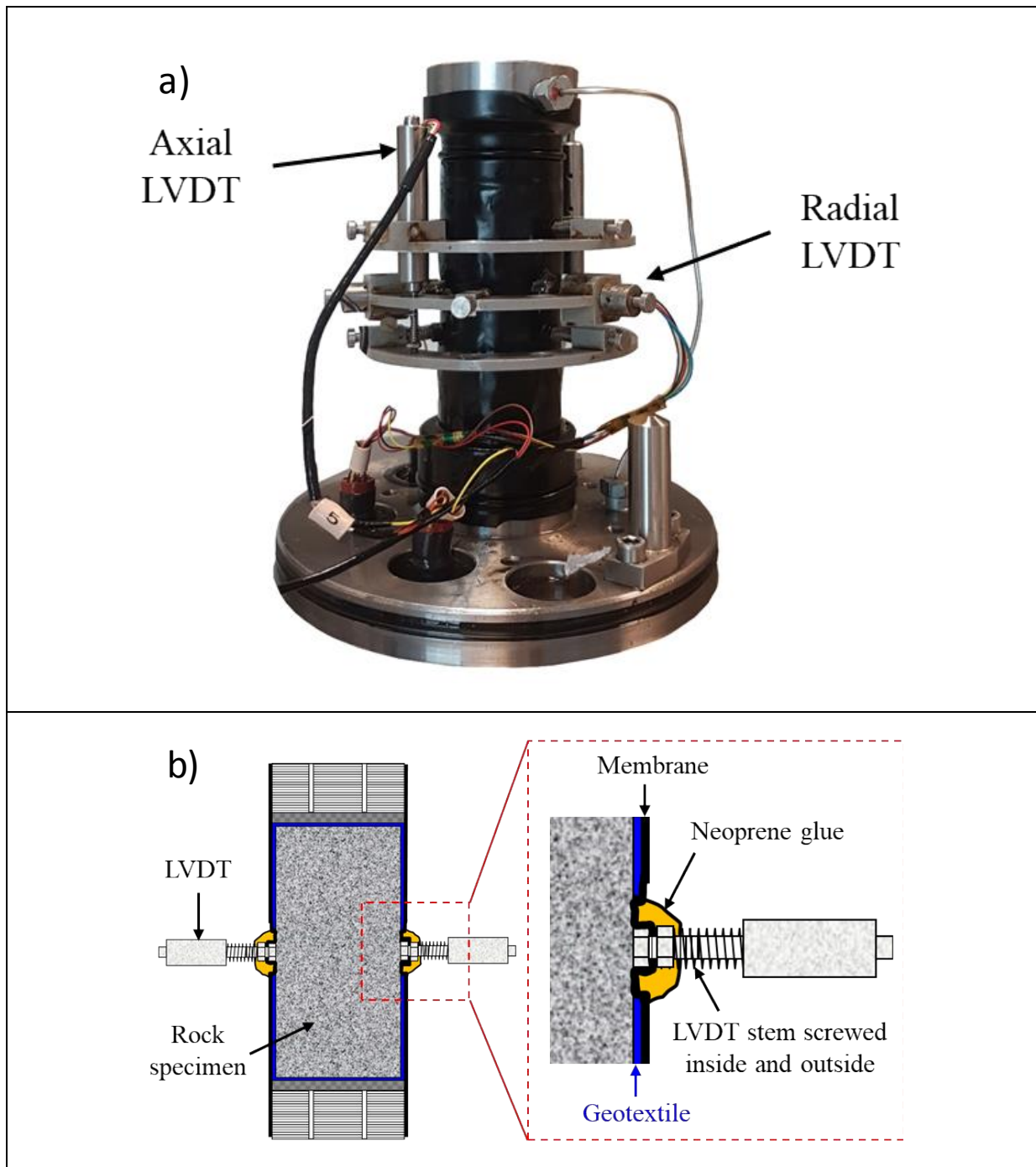

Figure 3. a) Local strain measurements device. Four radial LVDTs are fixed on a ring surrounding the specimen; the two axial LVDTs provide the changes in distance between two other rings tightly fixed on the specimen; b) Detail of the direct contact between the LVDT stem and the specimen through the neoprene membrane, with two bolts screwed on the stem on both sides of the membrane. Fluid tightness is ensured by a drop of neoprene glue put around the stem.

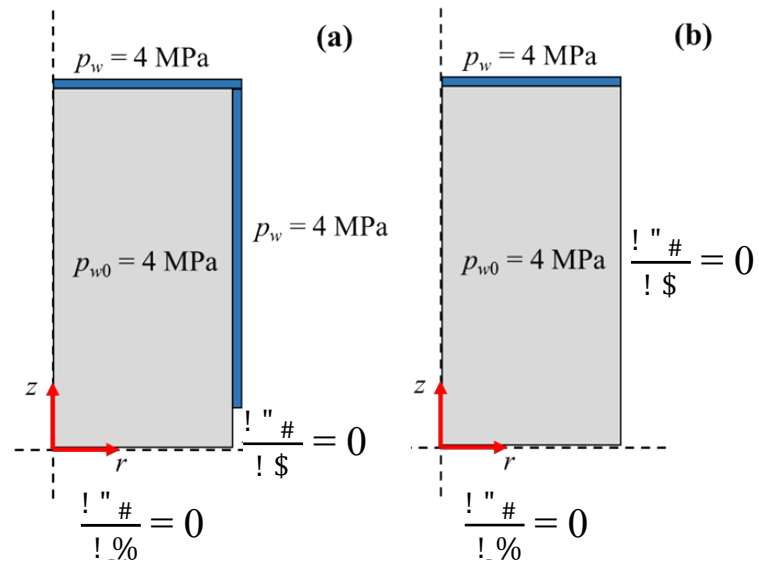

Figure 4. Initial and boundary conditions applied on a quarter upper right specimen in axisymmetric conditions: a) Enhanced drainage is made possible thanks to both the top porous disk and the lateral geotextile connected to it; b) Simple drainage by the top porous disk only.

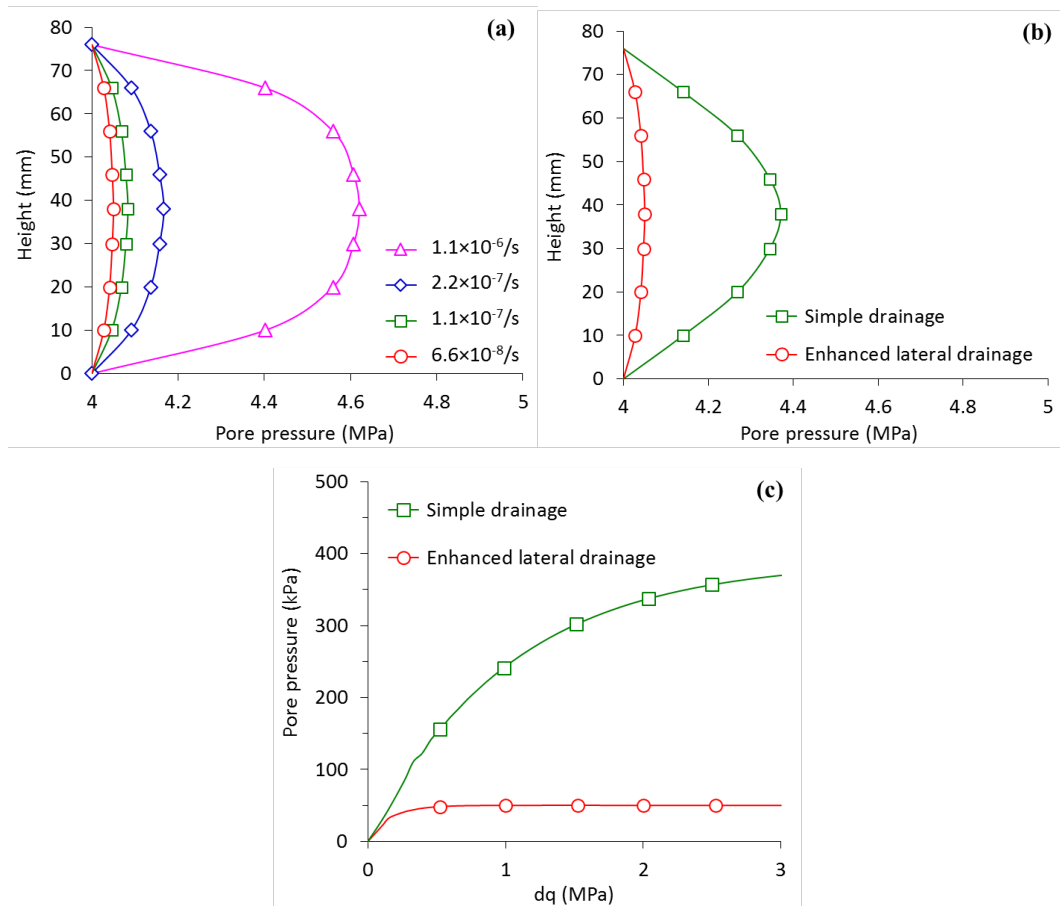

Figure 5. a) Calculated excess pore pressure profiles at steady state at different rates with enhanced lateral drainage, showing satisfactory drainage at strain rates of  $6.6 \times 10^{-8}$  and  $1.1 \times 10^{-7} s^{-1}$ ; b) Comparison between simple and enhanced lateral drainage at a rate of  $6.6 \times 10^{-8} s^{-1}$ ; c) Pore pressure changes at the centre of the sample at a rate of  $6.6 \times 10^{-8} s^{-1}$ , showing no stabilisation in pore pressure with simple drainage.

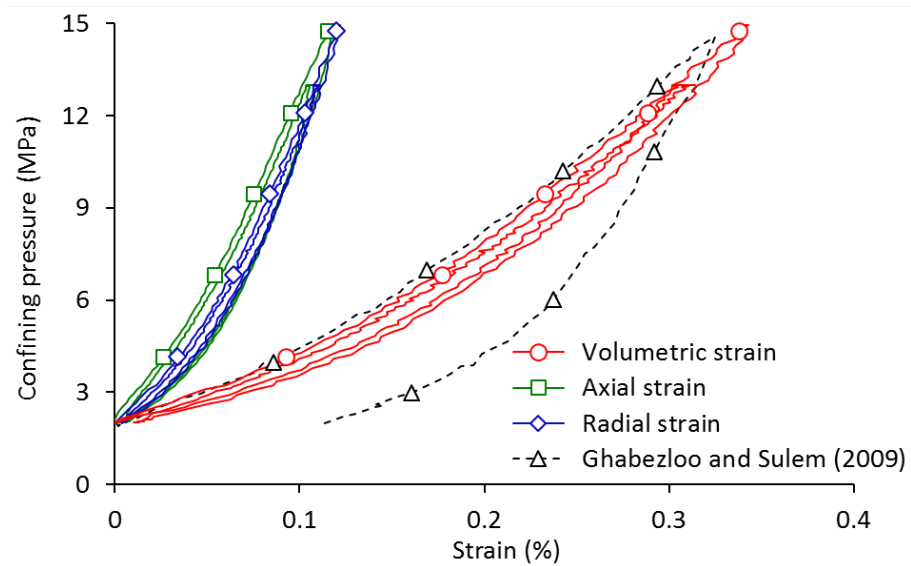

Figure 6. Drained isotropic compression test carried out on Rothbach sandstone (porosity  $\phi = 16\%$ , permeability  $k = 5 \times 10^{-3} \text{ m}^2$ ), showing good comparability with the data of Ghabezloo and Sulem (2009).

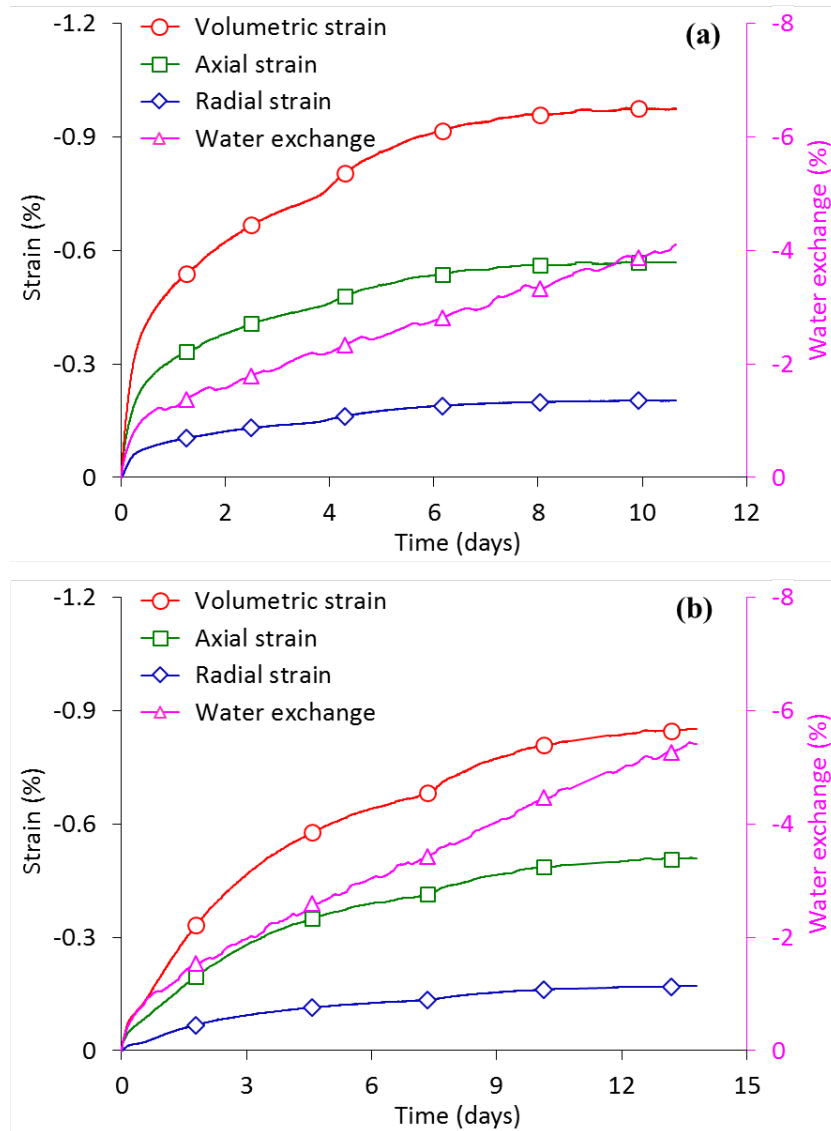

Figure 7. Saturation phase: (a) EST51338a, (b) EST51338b. The volume changes could not be derived from the water volume absorbed monitored by the back-pressure PVCs because of leaks in the back-pressure circuit, that resulted in having linear water exchanges in both cases.

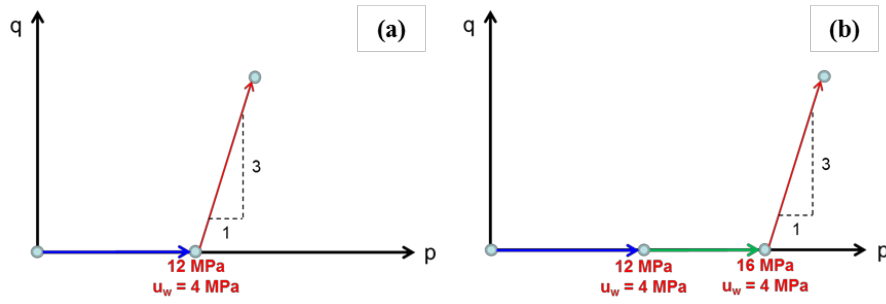

Figure 8. Stress paths followed, with constant confining stress: a) Test on specimen EST51338a, submitted to an initial Terzaghi effective stress of 8 MPa, close to in-situ stress conditions; b) Test on specimen EST51338b, at 1.5 time the mean Terzaghi effective stress (12 MPa).

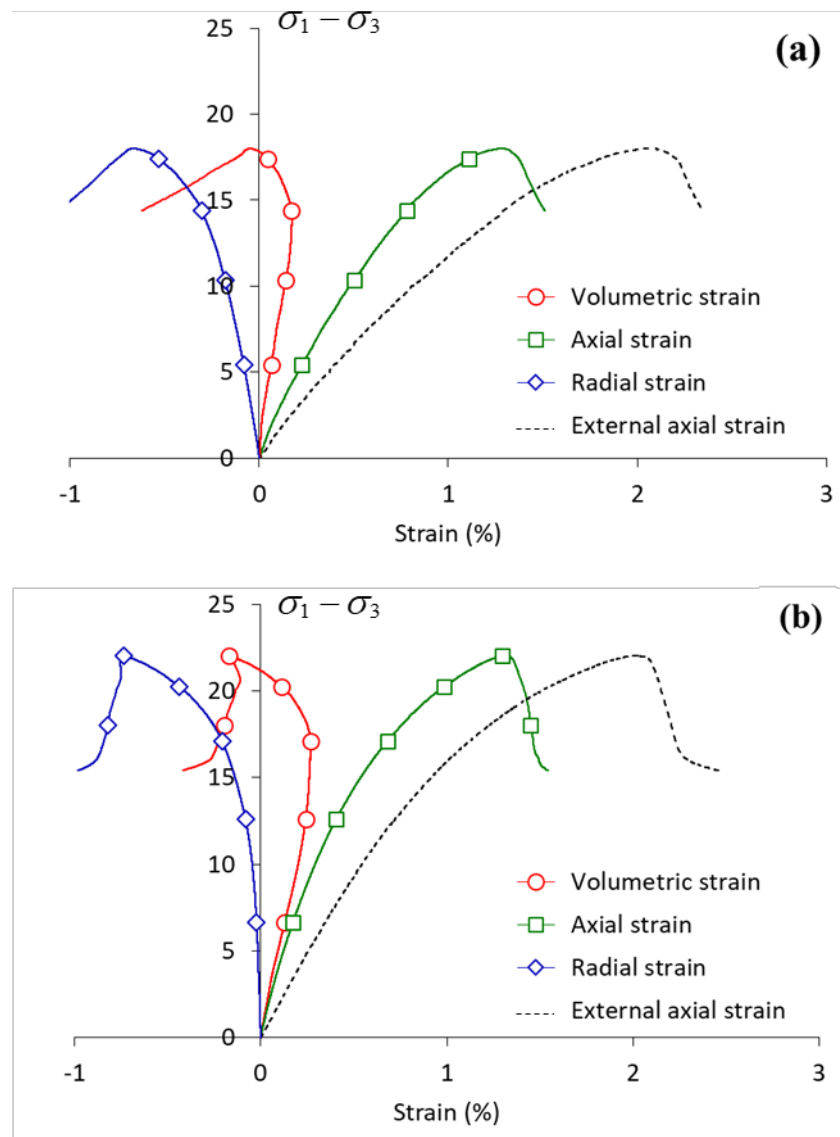

Figure 9. Stress strain curves of the drained sheared tests. External axial strains are in both cases larger than local ones. Similar contraction-dilation is observed in both cases, with a negative volumetric strain at peak (slight expansion) a) Specimen EST51338a under initial conditions close to in-situ mean effective stress (8 MPa); b) Specimen EST51338b under around 1.5 in-situ mean effective stress (12 MPa).



Figure 10. Sheared specimen (EST51338b), with shear plane inclined at an angle of  $65^\circ$  from horizontal.

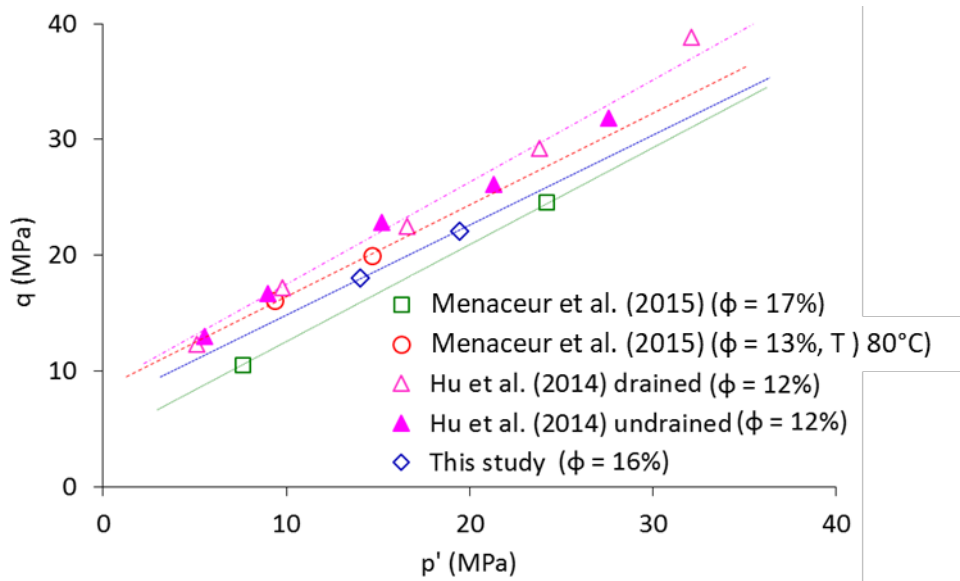

Figure 11. Comparison of the shear envelopes determined in this work (porosity 16%) with data of shear tests determined with different devices on saturated specimens of the Callovo-Oxfordian claystone with porosities between 12 and 17%: Menaceur et al. (2015) on hollow cylinder specimens; Hu et al. (2014) on small size triaxial specimens, either drained or undrained. Both devices had same drainage length (10 mm) with strain rates of  $0.9 \times 10^{-7} \text{ s}^{-1}$  and  $1.0 \times 10^{-7} \text{ s}^{-1}$ , respectively. Shear envelopes are well organised with respect to the porosity.

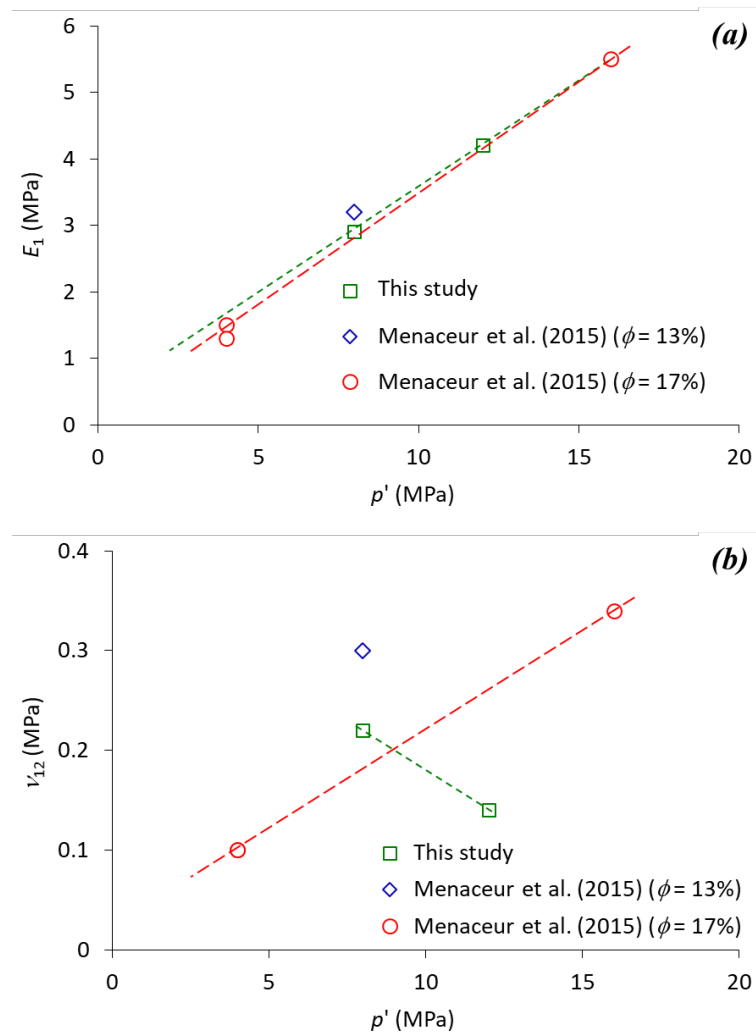

Figure 12. Comparison of the elastic parameters determined in this work with those of Menaceur et al. (2015): a) Young's modulus, with good comparability between tests and a linear increase with the confining stress; b) Poisson's ratio, with poor comparability, probably due to the difficulties in accurately measuring this parameter due to the very small radial strains mobilised.

Table 1. Initial characteristics of the tested specimens.

ID Ech.	$w$ (%)	$\rho$ (Mg/m <sup>3</sup> )	$\rho_d$ (Mg/m <sup>3</sup> )	$e$	$S_r$ (%)	$\phi$ (%)	Suction (MPa)
EST51338a	5.97	2.41	2.27	0.19	87.9	16.2	36.2
EST51338b	5.97	2.41	2.27	0.19	87.9	16.2	36.2

Table 2. Strength and elastic parameters of the tested specimens of COx claystone.

Test	$\sigma'$ (MPa)	$q_{max}$ (MPa)	$E_1$ (GPa)	$\nu_{12}$ (-)
EST51338a	8	18	2.9	0.22
EST51338b	12	22	4.2	0.14