

6<sup>th</sup> International Conference on Coupled  
THMC Processes in Geosystems



# GEOPROC 2017

# Book of Abstracts

5-7 July 2017

IFSTTAR, Ecole des Ponts ParisTech  
Paris, France

I. Stefanou, J. Sulem  
T. Poulet, K. Regenauer-Lieb, M. Veveakis





## GeoProc 2017

As part of GeoProc conference series, this event carries forward certain traditions as well as breaks new grounds related to Coupled Thermo-Hydro-Mechano-Chemical (THMC) processes in Geosystems.

After Stockholm, Sweden, in 2003 (GeoProc03), Nanjing, China, in 2006 (GeoProc06), Lille, France in 2008 (GeoProc08), Perth, Western Australia in 2011 (GeoProc11) and Utah, United States in 2015 (GeoProc15), the 6th GeoProc is held in Paris, France, at the Ecole des Ponts ParisTech, between 5 and 7 July 2017.

It is co-organized by the Ecole des Ponts ParisTech ([ENPC](#)), the French institute of science and technology for transport, spatial planning, development and networks ([IFSTTAR](#)), the University of New South Wales ([UNSW](#)) and the Commonwealth Scientific and Industrial Research Organisation ([CSIRO](#)).

The conference theme “Multiphysical processes and phenomena across the scales” symbolizes scientists, engineers and practitioners coming together from different backgrounds to address common scientific issues for a wide range of natural and engineering phenomena in geological systems and energy production. These phenomena include traditional fields, such as oil extraction, nuclear waste disposal, formation of mineral deposits, induced seismicity and natural hazards, as well as some new emerging areas, such as enhanced oil and gas recovery, geothermal energy and CO<sub>2</sub> geological sequestration. Although each field may have its own characteristics, a number of common scientific issues remain the same.

Geoproc gives emphasis into approaches that highlight the coupled multiphysical aspects of the applications as well as the techniques used to approach them.

On behalf of all people who contributed to the organisation of the event we wish all participants a successful GeoProc2017 conference

Ioannis Stefanou  
Jean Sulem  
Thomas Poulet  
Klaus Regenauer-Lieb  
Manolis Veveakis





<b>Chairs and co-chairs</b>	Dr Ioannis Stefanou ( <i>Laboratoire Navier, ENPC, IFSTTAR, France</i> )
	Prof. Jean Sulem ( <i>Laboratoire Navier, ENPC, France</i> )
	Dr Thomas Poulet ( <i>CSIRO, UNSW Australia</i> )
	Prof. Klaus Regenauer-Lieb ( <i>UNSW, Australia</i> )
	Dr Manolis Veveakis ( <i>UNSW, CSIRO, Australia</i> )
<b>Local organizing committee</b>	Dr Siavash Ghabezloo ( <i>Laboratoire Navier, ENPC</i> )
	Dr Jean-Michel Pereira ( <i>Laboratoire Navier, ENPC</i> )
	Mr Hadrien Rattiez ( <i>Laboratoire Navier, ENPC</i> )
	Dr Ioannis Stefanou ( <i>Laboratoire Navier, ENPC, IFSTTAR</i> )
<b>Scientific committee</b>	Prof. Einat Aharonov ( <i>The Hebrew University of Jerusalem, Israel</i> )
	Dr Marco Barla ( <i>Politecnico di Torino, Italy</i> )
	Dr Daniel Billaux ( <i>ITASCA, France</i> )
	Dr Andrew P. Bungler ( <i>University of Pittsburgh, USA</i> )
	Dr Frederic Collin ( <i>ULg, Belgium</i> )
	Prof. Emmanuel Detournay ( <i>University of Minnesota, USA</i> )
	Prof. Claudio Di Prisco ( <i>Politecnico di Milano, Italy</i> )
	Prof. Itai Einav ( <i>University of Sydney, Australia</i> )
	Prof. Sergio Fontoura ( <i>Pontifical Catholic Univ. of Rio de Janeiro, Brazil</i> )
	Prof. Antonio Gens ( <i>Polytechnic University of Catalonia, Spain</i> )
	Dr Siavash Ghabezloo ( <i>Laboratoire Navier, ENPC, France</i> )
	Prof. Tomasz A. Hueckel ( <i>Duke University, USA</i> )
	Prof. Lyesse Laloui ( <i>EPFL, Switzerland</i> )
	Prof. Euripides Papamichos ( <i>Aristotle University of Thessaloniki, Greece</i> )
	Prof. Panos Papanastasiou ( <i>University of Cyprus, Cyprus</i> )
	Dr Jean-Michel Pereira ( <i>Laboratoire Navier, ENPC, France</i> )
	Dr Robert Podgorney ( <i>INL, USA</i> )
	Dr Thomas Poulet ( <i>UNSW, CSIRO, Australia</i> )
	Prof. Ahmad Pouya ( <i>Laboratoire Navier, ENPC, IFSTTAR, France</i> )
	Prof. Alexander Puzrin ( <i>ETH Zürich, Switzerland</i> )
	Prof. Klaus Regenauer-Lieb ( <i>UNSW, Australia</i> )
	Prof. James R. Rice ( <i>Harvard, USA</i> )
	Prof. John Rudnicki ( <i>Northwestern University, USA</i> )
Dr Jonny Rutqvist ( <i>Berkeley Lab, USA</i> )	
Dr Alexandre Schubnel ( <i>ENS, France</i> )	



Prof. Patrick Selvadurai (*McGill University, Canada*)  
 Dr Darius Seyedi (*ANDRA, France*)  
 Prof. Jianfu Shao (*University of Lille, France*)  
 Prof. Christopher Spiers (*University of Utrecht, Netherlands*)  
 Dr Ioannis Stefanou (*Laboratoire Navier, ENPC, IFSTTAR, France*)  
 Prof. Jean Sulem (*Laboratoire Navier, ENPC, France*)  
 Dr Manolis Veveakis (*UNSW, CSIRO, Australia*)  
 Dr Robert Viesca (*Tufts University, USA*)  
 Prof. Gioacchino Viggiani (*Lab. 3S, Université Grenoble Alpes, France*)



## Organized by



## Sponsors



LABEX MMCD



ISRM



CFMR





**Einat Aharonov**  
*Hebrew University*

A steady-state physics-based rock-friction constitutive law: predicting friction dependence on temperature, stress and slip rate



**Yves Guglielmi**  
*CEREGE Laboratory & Berkeley lab*

Fault slip experiments in Earth Laboratories - Insights into the couplings between permeability creation, stimulated fault area and aseismic / seismic slip



**Atef Onaisi**  
*Head of Geomechanics Services, Total*

1D and 3D geomechanical modelling workflows and field applications in Total



**James Rice**  
*Harvard University*

Thermo-hydro-mechanical processes stabilizing Antarctic ice stream shear margins



**Alexandre Schubnel**  
*École Normale Supérieure, Paris*

Strength and Anisotropy in Tournemire Shale: Temperature, Pressure and Time Dependences



**Chris J. Spiers**  
*Utrecht University*

Effects of THMC processes on rock and fault behavior under upper crustal conditions



# Table of contents

<b>Analysis of the non-linear dynamics of chemically active creeping faults</b> Alevizos Sotiris [et al.] . . . . .	6
<b>Effects of temperature on the instantaneous and time dependent volume changes of the Callovo-Oxfordian claystone</b> Belmokhtar Malik [et al.] . . . . .	8
<b>Hydro-mechanical modelling of a coalbed methane production well via a dual-porosity approach</b> Bertrand Francois [et al.] . . . . .	10
<b>Thermo-mechanical behavior of clays explained from the nanoscale</b> Brochard Laurent [et al.] . . . . .	12
<b>A multiscale numerical modeling of elastoplastic behavior of saturated double porous geomaterials</b> Cao Yajun [et al.] . . . . .	14
<b>Flexible parallel implicit modelling of fractured reservoirs</b> Cacace Mauro [et al.] . . . . .	16
<b>Vaporization of fault water during seismic slip</b> Chen Jianye [et al.] . . . . .	18
<b>Inverse Proportionality Between Energy Intensities and their Consequences</b> Couples Gary . . . . .	20
<b>Superposition of processes may explain post-injection seismicity in deep geothermal systems</b> De Simone Silvia [et al.] . . . . .	22
<b>Chemical Control of Fracture Permeability, Injectivity, and Reservoir Sweep in Geologic CO<sub>2</sub> Storage</b> Dewers Thomas [et al.] . . . . .	24
<b>Coupled CFD-DEM simulation of slip instabilities in sheared granular layer: applications to granular fault gouge</b> Dorostkar Omid [et al.] . . . . .	26
<b>Micromechanical modeling of time-dependent behavior of a typical shale rock</b> Farhat Faten [et al.] . . . . .	28
<b>Progressive damage and strain localization in modelling pre-eruptive deformation: analytical and numerical results</b> Got Jean-Luc [et al.] . . . . .	30
<b>Extent of Tensile Cracking Induced by a Hydraulic Fracture</b> Garagash Dmitry [et al.] . . . . .	32
<b>Implementation of a softening-healing law in a distinct element fluid injection simulation</b> Ghazal Rima [et al.] . . . . .	34

<b>Non-symmetry of a hydraulic fracture due to the inhomogeneity of the reservoir</b>	
Golovin Sergey . . . . .	36
<b>Numerical Advances to simulate Shear Failure and Tensile Failure due to Hydraulic Fracturing Operations</b>	
Gómez Castro Berta María [et al.] . . . . .	38
<b>Gas seepage from saturated sediments: Coupling flow and Geomechanics</b>	
Holtzman Ran [et al.] . . . . .	40
<b>On Poroelastic State Initialization under the Influence of Gravity</b>	
Holzbecher Ekkehard . . . . .	42
<b>THMC in deep geological nuclear waste disposal</b>	
Hu Manman [et al.] . . . . .	44
<b>Model development for fully coupled hydro-thermal-mechanical analysis of brine migration in salt</b>	
Hu Mengsu [et al.] . . . . .	46
<b>Long-term and short-term evolution of engineering properties of geomaterials</b>	
Hueckel Tomasz [et al.] . . . . .	48
<b>From localized to homogeneous deformation of porous rocks - insights from laboratory experiments and numerical modelling</b>	
Jacquey Antoine [et al.] . . . . .	50
<b>Modeling stress transfer during hydraulic stimulation of geothermal reservoirs</b>	
Jansen Gunnar [et al.] . . . . .	52
<b>Finite Strain description of Fractal Damage in Geo-materials</b>	
Karrech Ali [et al.] . . . . .	54
<b>Hydraulic apertures of open and sealing fractures</b>	
Kling Tobias [et al.] . . . . .	56
<b>Computational upscaling of Drucker-Prager plasticity from micro-CT images of synthetic porous rock</b>	
Liu Jie [et al.] . . . . .	58
<b>Fluid-rock interactions in THMC simulations: its numerical challenges and future modeling perspectives</b>	
Leal Allan [et al.] . . . . .	60
<b>Fluid pressure feedback on rocks at the micro-scale</b>	
Lesueur Martin [et al.] . . . . .	62
<b>Tracer tests and numerical simulations on nonlinear fluid flow behaviors in 2D fracture networks</b>	
Li Bo [et al.] . . . . .	64
<b>Analytical model of self-sealing process of fractures in claystone</b>	
Maghsoodi Soheib [et al.] . . . . .	66
<b>Poroviscoelastic behavior of common sedimentary rock</b>	
Makhnenko Roman [et al.] . . . . .	68
<b>Experimental characterization of THMC behavior in granular un cemented media during heavy oil production (EOR)</b>	
Martin Ruiz Miriam [et al.] . . . . .	70
<b>Numerical THM Modelling of Performance of Radially Jet-Drilled Laterals in Chalk Reservoirs</b>	
Medetbekova Maiya [et al.] . . . . .	72

<b>Thermal shear reactivation in the Callovo-Oxfordian claystone</b>	
Menaceur Hamza [et al.] . . . . .	74
<b>Reactive flow patterns in fractured media</b>	
Mindel Julian [et al.] . . . . .	76
<b>Tip asymptotic of a hydraulic fracture driven by a power law fluid accounting for the presence of a fluid lag</b>	
Moukhtari Fatima-Ezzahra [et al.] . . . . .	78
<b>Energy-based approaches for the computation of fracture parameters in poroelastic media</b>	
Nejati Morteza . . . . .	80
<b>Numerical modeling of rock fracturing in geothermal systems</b>	
Ngo Dac-Thuong [et al.] . . . . .	82
<b>Thermal behavior of an underground heat storage designed for large scale thermo-electric energy storage</b>	
Nguyen Denis [et al.] . . . . .	84
<b>Modelling continental glaciation to verify the robustness of the geosphere as a barrier to radionuclide migration from a deep geological repository</b>	
Nguyen Son [et al.] . . . . .	86
<b>Characterization of bentonite seal infiltrated with brine from laboratory test and theoretical modelling</b>	
Nguyen Son [et al.] . . . . .	88
<b>Modelling the desiccation induced damage zone for a bedded argillaceous rock with a visco-elastoplastic model</b>	
Nguyen Son [et al.] . . . . .	90
<b>Effect of thermal cycles on the mechanical behavior of a model energy pile in dry sand</b>	
Nguyen Van Tri [et al.] . . . . .	92
<b>Coupling mechanical and swelling effects on natural stiff clays under unloading-reloading loops</b>	
Nguyen Xuan-Phu [et al.] . . . . .	94
<b>Earthquake rupture modeling on complex fault systems and complex media</b>	
Okubo Kurama [et al.] . . . . .	96
<b>The effects of temperature on oil wellbore stability in rocks using coupled THM numerical simulation</b>	
Oliaei Mohammad [et al.] . . . . .	98
<b>Experimental characterization of desiccation of lime treated clayey silt</b>	
Poncelet Nicolas [et al.] . . . . .	100
<b>Hydraulic – natural fracture interactions and stress field perturbation, insights from a coupled 3D discrete element model</b>	
Papachristos Eftymios [et al.] . . . . .	102
<b>Pore and grain scale changes during pore collapse and liquefaction in chalk</b>	
Papamichos Euripides [et al.] . . . . .	104
<b>Crack-tip plastic deformation in fluid-saturated solids</b>	
Papanastasiou Panos . . . . .	106
<b>Boudinage and folding as the same fundamental energy instability in ductile deformation</b>	
Peters Max [et al.] . . . . .	108



<b>Numerical modelling of multi-physics instabilities using REDBACK</b>	
Poulet Thomas [et al.] . . . . .	110
<b>Localization of deformation in a fault gouge with Cosserat microstructure and THCM couplings</b>	
Rattez Hadrien [et al.] . . . . .	112
<b>Numerical analysis of strain localization in a Cosserat continuum with THM couplings</b>	
Rattez Hadrien [et al.] . . . . .	114
<b>Multiscale THMC Coupling for Next Generation Reservoir Engineering</b>	
Regenauer-Lieb Klaus . . . . .	116
<b>Earthquake cycles in geometrically complex faults with ageing rate and state friction</b>	
Romanet Pierre [et al.] . . . . .	118
<b>Hydro-mechanical modelling of a gallery sealing over the entire life of a deep repository</b>	
Ruiz Daniel [et al.] . . . . .	120
<b>Coupled fluid flow and geomechanical modeling studies on fault activation, induced seismicity and potential fault leakage in geologic carbon storage</b>	
Rutqvist Jonny [et al.] . . . . .	122
<b>The effects of temperature perturbation and chemical reactions on flow-channeling in fractured geothermal doublets</b>	
Salimzadeh Saeed [et al.] . . . . .	124
<b>Modelling of the poro-elastoplastic behavior of an early-age cement paste: application to well cementing</b>	
Samudio Marcos [et al.] . . . . .	126
<b>Studying overpressure and stress heterogeneity above a deep geothermal reservoir: a multi-physics rock mechanical approach</b>	
Seithel Robin [et al.] . . . . .	128
<b>THM Behavior of a Fluid Inclusion</b>	
Selvadurai A.p.s. [et al.] . . . . .	130
<b>A coupled RBSM-DFN modeling of hydraulic fracturing</b>	
Shao Jian-Fu . . . . .	132
<b>Microstructure and Thermo-Hydro-Mechanical effects as an explanation of rate dependency during seismic slip</b>	
Stefanou Ioannis [et al.] . . . . .	134
<b>Strain localisation in submerged slopes due to rapid sedimentation</b>	
Stoecklin Andreas [et al.] . . . . .	136
<b>Multiphysics couplings and strain localization in fault zones</b>	
Sulem Jean [et al.] . . . . .	138
<b>Experimental investigation of pore pressure propagation around the borehole during drilling in gas shale formations</b>	
Tianshou Ma [et al.] . . . . .	140
<b>A numerical approach for simulation of shear dilation of three-dimensional fracture networks</b>	
Ucar Eren [et al.] . . . . .	142
<b>An X-FEM technique for simulation of hydraulic fracturing in impervious fractured domains: numerical and experimental investigations</b>	
Vahab Mohammad [et al.] . . . . .	144

<b>The impact of thermal cycles on the mobilization of shear strength for energy piles</b>	
Vasilescu Andreea [et al.] . . . . .	146
<b>Coupled Thermo-Hydro-Mechanical Behavior of Shale</b>	
Vilarrasa Victor [et al.] . . . . .	148
<b>Thermo-hydro-mechanical modeling of an in situ heating test in the Callovo-Oxfordian claystone</b>	
Vitel Manon [et al.] . . . . .	150
<b>Mechanical degradation analysis of sandstone under chemical corrosion</b>	
Wang Wei [et al.] . . . . .	152
<b>Flow of CO<sub>2</sub>-rich fluids in simulated wellbore interfaces: Experiments and models exploring reactive transport on length scales of several metres</b>	
Wolterbeek Tim [et al.] . . . . .	154
<b>Hydro-mechanical time-dependent deformation, creep and fracturing of brittle rocks</b>	
Xu Tao [et al.] . . . . .	156
<b>Mechanical properties of thin-layered rock masses in dry and water-soaked conditions and their influences on stability of large tunnels</b>	
Zhang Yuting [et al.] . . . . .	158
<b>Multiphysics modelling in the frame of deep geothermal energy systems</b>	
Dimier Alain . . . . .	160
<b>3D Numerical Study on Permeability Property of Columnar Jointed Rock</b>	
Meng Qingxiang [et al.] . . . . .	162
<b>Research on the impact of principle stress ratio on geological disaster</b>	
Song Zhenlong [et al.] . . . . .	164
<b>Experimental investigation of shear creep behavior of discontinuity involved in rock mass</b>	
Wang Huanling [et al.] . . . . .	166
<b>Hydro-mechanical Coupled Elasto-visco-plastic Damage Analysis of Columnar Jointed Basalt in Baihetan Hydropower Station</b>	
Xu Weiya [et al.] . . . . .	168
<b>Numerical Homogenization Analysis on Elastic Property of Jointed Rock with Crystalline Structure</b>	
Xu Weiya [et al.] . . . . .	170
<b>Author Index</b> . . . . .	172



## GeoProc2017

6th International Conference on Coupled THMC Processes in Geosystems  
5-7 Jul 2017 Paris (France)

### **Analysis of the non-linear dynamics of chemically active creeping faults**

*S. Alevizos<sup>1</sup>, T. Poulet<sup>2</sup>, T. Morh-Durdez<sup>3</sup>, V. Boussange<sup>4</sup>, M. Veveakis<sup>5</sup> & K. Regenauer-Lieb<sup>6</sup>*

*Keywords: Linear and non-linear dynamics, homoclinic bifurcation, pseudo arc-length continuation, subduction zones*

Shear heating can play a major role in weakening of faults, triggering thermal effects (clay dehydration, flash heating of contacts, melting, chemical reactions) that lead to seismic slip (Rice 2006). Fluid-releasing chemical reactions are shown to be capable of setting in motion a chemo-mechanical oscillator that can explain the Episodic Tremor and Slip sequence in subduction environments (Poulet et al. 2014a) and the spatial manifestation of exhumed thrusts (Poulet et al. 2014b). The main feature of the mathematical framework (Alevizos et al. 2014) is the tight coupling of a shear heating mechanism due to the material's internal friction, to a reversible, endothermic chemical reaction triggered by the temperature increase caused by prolonged shearing.

In this study, we recapitulate the model's main features and use Keller's pseudo arc-length continuation method (Chan & Keller 1981) along with Spectral Element Method to produce bifurcation diagrams of its equilibrium solutions (Fig. 1). The typical response is that of an S-curve, comprising of two branches that are either stable or present stable limit cycles, separated by an unstable one. Furthermore, we perform a parametric analysis and through a series of test functions, we trace steady-state bifurcation points in an extended parameter space consisting of 4 main dimensionless groups. Due to the appearance of Hopf points in the upper branch of the solutions, we perform a periodic solution continuation that reveals the existence of both stable and unstable limit cycles (Fig. 2). The main observation is that the equilibrium is found to be depending on the so-called Grunfest number, which is a measure of the energy supplied to the fault, while the non-linear dynamics are mainly controlled by the Lewis number, which is the ratio of energy diffusion over mass diffusion. The numerical analysis finally leads to the discovery that the lower turning point B (Fig. 1) which marks the onset of instability, defines the system's global behavior, since it is also a homoclinic point.

<sup>1</sup> School of Petroleum Engineering, UNSW, Kensington, NSW, Australia, s.alevizos@unsw.edu.au

<sup>2</sup> CSIRO Mineral Resources, North Ryde, NSW, Australia, Thomas.Poulet@csiro.au

<sup>3</sup> Ecole Polytechnique, France, theophile.mohr-durdez@polytechnique.edu

<sup>4</sup> INSA Lyon, France, victor.boussange@insa-lyon.fr

<sup>5</sup> School of Petroleum Engineering, UNSW, Kensington, NSW, Australia, e.veveakis@unsw.edu.au

<sup>6</sup> School of Petroleum Engineering, UNSW, Sydney, NSW, Australia, klaus@unsw.edu.au

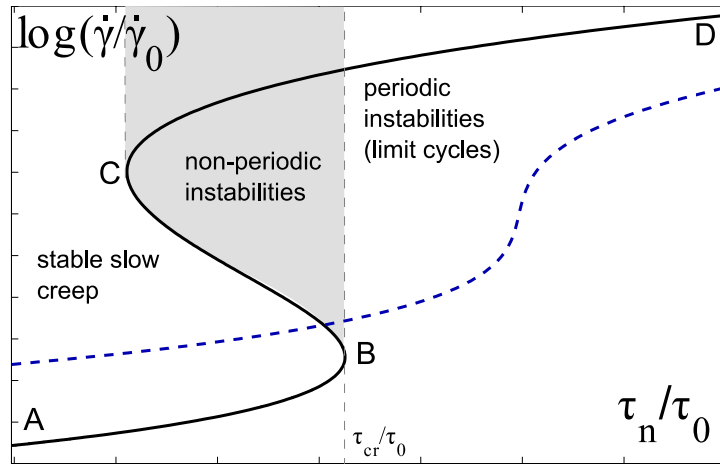

Figure 1. Bifurcation diagram of the model proposed by Alevizos et al. (2014). The system exhibits a folded S-curve response (solid black curve) or a stretched one (dashed blue curve) depending on the normal stress at the fault's boundary.

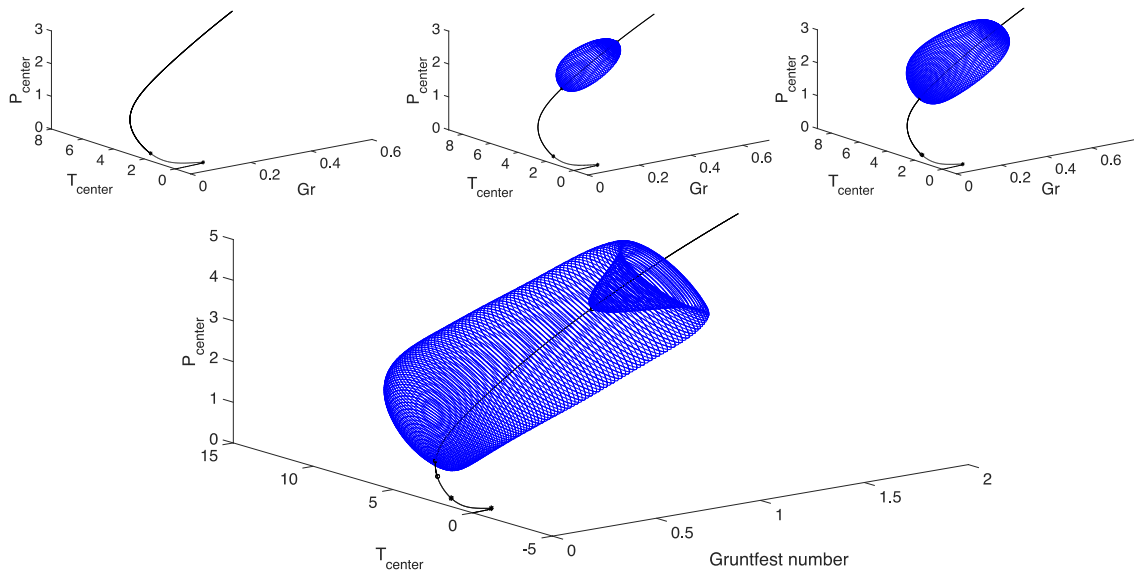

Figure 2. 3-D bifurcation diagrams of the fault's temperature and excess pore-pressure with respect to the Gruntfest number for varying values of the Lewis number, revealing areas of stable and unstable oscillations.

## References

- Alevizos, S., Veveakis, M., and Poulet, T. (2014), Thermo-poro-mechanics of chemically active creeping faults: 1. steady state, *J. Geophys. Res. Solid Earth*, 119, 4558-4582.
- Chan, T., and Keller, H. (1981), Arc-length continuation and multi-grid techniques for nonlinear elliptic eigenvalue problems, *SIAM J. Sci. Stat. Comput.*, 3(2), 173–194.
- Poulet, T., Veveakis, M., Regenauer-Lieb, K., and Yuen, D., (2014a) Thermo-poro-mechanics of chemically active creeping faults: 3. the role of serpentinite in episodic tremor and slip sequences, and transition to chaos, *J. Geophys. Res. Solid Earth*, 119, 4606-4625.
- Poulet, T., Veveakis, M., Herwegh, M., Buckingham, T., and Regenauer-Lieb, K., (2014b) Modeling episodic fluid-release events in the ductile carbonates of the Glarus thrust, *Geophys. Res. Lett.*, 41, 7121-7128.
- Rice, J. R. (2006), Heating and weakening of faults during earthquake slip, *J. Geophys. Res.*, 111, B05311, doi:10.1029/2005JB004006.



## GeoProc2017

6th International Conference on Coupled THMC Processes in Geosystems  
5-7 Jul 2017 Paris (France)

### Thermal behaviour and creep of the Callovo-Oxfordian claystone

*M. Belmokhtar<sup>1</sup>, P. Delage<sup>1</sup>, S. Ghabezloo<sup>1</sup>, N. Coni<sup>2</sup>*

*Keywords: Thermal volume change, creep, local strains, claystone, saturation*

In various countries (France, Belgium, Switzerland..), clays and claystones are considered as a potential host rock for high-level long-lived radioactive wastes disposal. In France, the properties of the Callovo-Oxfordian (COx) claystone is investigated by the French National Radioactive Waste Management Agency (Andra) in the Meuse Haute-Marne Underground Research Laboratory (MHM URL) near Bure (Northeast France).

Temperature elevation due to the exothermic nature of radioactive wastes (planned to be smaller than 100°C) will affect the host rock around the disposal cells. Many studies have been conducted to better understand the thermal volume changes of clays and claystones (including Hueckel and Baldi, 1990; Sultan et al., 2002; Monfared et al., 2011).

In this work, the thermal volumetric response of the COx claystone was investigated by using a new thermal isotropic compression cell, developed with particular attention devoted to monitoring axial and radial strains through a high precision LVDTs device with direct contact between the LVDT stem and the sample through the membrane.

Full saturation of the sample under stress conditions close to in-situ and fully drained conditions during compression were carefully achieved thanks to the short drainage length (10 mm) adopted (the height of the specimen with drainage at bottom). High precision strain monitoring allowed to observe a volumetric creep under stress conditions close to in-situ. A drained heating (Figure 1) test under constant stress carried out afterwards up to 80°C exhibited a thermo-elastic expansion up to a temperature of 48°C, followed by thermo-plastic contraction at higher temperature.

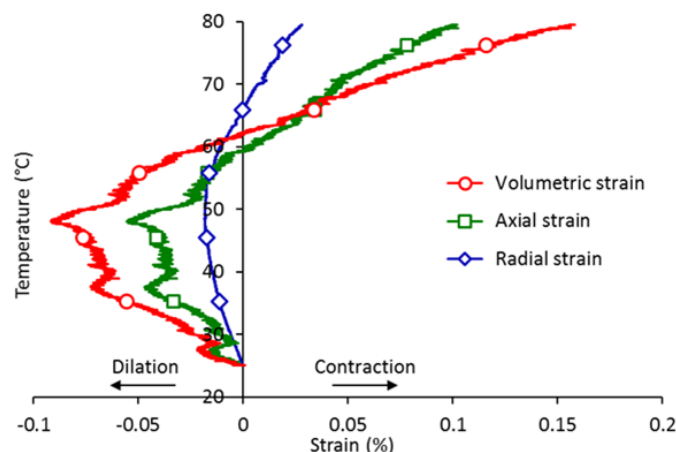

Figure 1. Measured strains during drained heating test.

<sup>1</sup> Laboratoire Navier/CERMES, Ecole des Ponts Paris Tech, 6-8 Av. B. Pascal, 77455 Marne la Vallée, France

<sup>2</sup> Andra URL, Bure, France

Creep volume changes, that appeared to be significantly enhanced by temperature (Figure 2), were modelled by using a simple Kelvin-Voigt model, so as to estimate the instantaneous response of the COx claystone and to determine its thermal expansion coefficient.

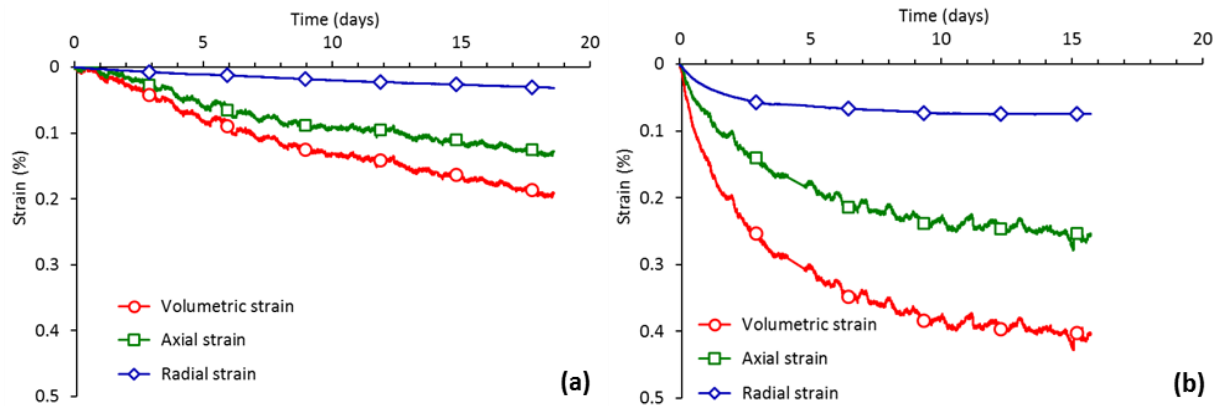

Figure 2. Measured strains during drained heating test.

The temperature at which the transition between thermal expansion and contraction appeared is close to the maximum burial temperature of the Callovo-Oxfordian claystone, estimated at  $50\pm 5^{\circ}\text{C}$  (Blaise et al., 2014). This is in agreement with a phenomenon already observed on the Opalinus clay by Monfared et al., (2011), that was interpreted as a thermal hardening phenomenon, showing that the material kept the memory of the highest temperature supported during its geological history.

## References

- T. Blaise, J. Barbarand, M. Kars, F. Ploquin, C. Aubourg, B. Brigaud, M. Cathelineau, A. El Albani, C. Gautheron, A. Izart, D. Janots, R. Michels, M. Pagel, J-P. Pozzi, M-C. Boirona, P. Landrein (2014), Reconstruction of low temperature ( $<100^{\circ}\text{C}$ ) burial in sedimentary basins: A comparison of geothermometer in the intracontinental Paris Basin. *Marine and Petroleum Geology*, 53, 71–87. doi: 10.1016/j.marpetgeo.2013.08.019
- T. Hueckel, G. Baldi (1990), Thermoplasticity of saturated clays experimental constitutive study. *Journal of Geotechnical Engineering*, 116(12), 1778–1796. doi: 10.1061/(ASCE)0733-9410(1990)116:12(1778)
- M. Monfared, J. Sulem, P. Delage, M. Mohajerani (2011), A Laboratory Investigation on Thermal Properties of the Opalinus Claystone. *Rock Mechanics and Rock Engineering*. 44(6), 735–747. doi: 10.1007/s00603-011-0171-4
- N. Sultan, P. Delage, Y-J. Cui (2002), Temperature effects on the volume change behaviour of Boom clay. *Engineering Geology*, 64(2-3), 135–145. doi: 10.1016/S0013-7952(01)00143-0



## GeoProc2017

6th International Conference on Coupled THMC Processes in Geosystems  
5-7 Jul 2017 Paris (France)

### Hydro-mechanical modelling of a coalbed methane production well via a dual-porosity approach

*F. Bertrand<sup>1</sup>, O. Buzzi<sup>2</sup>, F. Collin<sup>3</sup>*

*Keywords: Unconventional reservoir, HM Couplings, Shape factors*

Most coal seams hold important quantities of methane which is recognized as a valuable energy resource [1]. Coal reservoir is not conventional because methane is held adsorbed on the coal surface [2]. Coal is a naturally fractured reservoir made of matrix blocks and cleats (*i.e.* fractures) [3]. In general, cleats are water saturated with the hydrostatic pressure maintaining the gas adsorbed in the coal matrix. Production of coalbed methane (CBM) first requires a decrease of the hydrostatic pressure. It is followed by desorption of methane from the matrix during which gas molecules diffuse through the matrix and then migrate through the cleat system (Figure 1) [4].

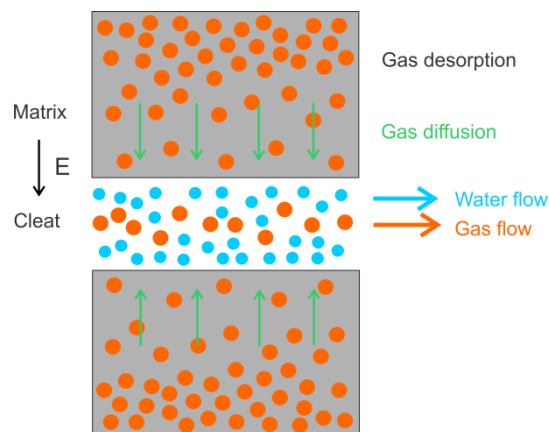

Figure1: Migration processes in coal.

Changes of coal properties during methane production are a critical issue in coalbed methane recovery. Any change of the cleat network will likely translate into modifications of the reservoir permeability. In particular, two distinct phenomena are known to result from reservoir pressure depletion [5]. First, the reservoir compaction due to the increase in the effective stress (Terzaghi's principle) tends to decrease the permeability. The second effect is the matrix shrinkage following gas desorption, which, in contrast, tends to increase the permeability.

<sup>1</sup>Université de Liège (Belgium), ArGEnCo Department, francois.bertrand@ulg.ac.be

<sup>2</sup> University of Newcastle (Australia), Centre of Excellence for Geotechnical Science and Engineering, olivier.buzzi@newcastle.edu.au

<sup>3</sup>Université de Liège (Belgium), ArGEnCo Department, f.collin@ulg.ac.be

This work consists in the formulation of a hydro-mechanical model of the reservoir at the macroscale. Due to the particular structure of coal, the model is based on a dual-continuum approach to enrich the macroscale with microscale considerations.

Regarding the mechanics, the matrix is treated as a linear elastic material [6] and the cleats are described as interfaces having a normal stiffness function of the cleat aperture. Elastic moduli of this dual system are then deduced for an equivalent continuum medium, by analogy with a series of two springs. Finally, the balance of momentum is used to express the mechanical equilibrium of the material.

Concerning the hydraulic aspects of the model, mass balance equations are established following a compositional approach [7] which consists of balancing the species rather than phases. Balance equations involve different variables such as densities, degrees of saturation or fluid fluxes. These dependent variables are linked to water pressure and gas pressure through some constitutive equations. For example, water flow is related to pressure gradients as per Darcy's equation. When applying Darcy's equation to the cleat network, the cubic law is used to compute the permeability from the fracture aperture. In the context of coalbed methane production, the Langmuir's isotherm gives the maximum quantity of adsorbed gas as a function of reservoir pressure. Finally, shape factors are employed to take into account the geometry of the matrix blocks in the formulation of the mass exchange term between the two systems, matrix and fractures [8].

The hydro-mechanical model here proposed is fully coupled. For example, it captures the sorption-induced volumetric strain or the dependence of permeability on fracture aperture, which evolves with the stress state. The model has been implemented with a finite element method in the Lagamine code and is used to model methane production at the scale of the production well. To date, attention has focused on a series of parametric analyses that can highlight the influence of the key parameters related to the reservoir (e.g. Langmuir's parameters and dimensions of the fractures and matrix blocks) and the well (pressure/pumping rate).

## References

- [1] Flores R. M. (1998), "Coalbed methane: from hazard to resource," *International Journal of Coal Geology*, vol. 35, no. 1, pp. 3–26.
- [2] Harpalani S. and Schraufnagel A. (1990), "Measurement of parameters impacting methane recovery from coal seams," *International Journal of Mining and Geological Engineering*, vol. 8, no. 4, pp. 369–384.
- [3] Laubach S., Marrett R., Olson J. and Scott A. (1998), "Characteristics and origins of coal cleat: a review," *International Journal of Coal Geology*, vol. 35, no. 1, pp. 175–207.
- [4] Moore T. A. (2012), "Coalbed methane: a review," *International Journal of Coal Geology*, vol. 101, pp. 36–81.
- [5] Gray I. et al. (1987), "Reservoir engineering in coal seams: Part 1-the physical process of gas storage and movement in coal seams," *SPE Reservoir Engineering*, vol. 2, no. 01, pp. 28–34.
- [6] Berkowitz N. (1979), *An introduction to coal technology*. Elsevier.
- [7] Collin F., Li X.-L., Radu J.-P. and Charlier R. (2002), "Thermo-hydro-mechanical coupling in clay barriers," *Engineering Geology*, vol. 64, no. 2, pp. 179–193.
- [8] Warren J., Root P. J., et al. (1963), "The behavior of naturally fractured reservoirs," *Society of Petroleum Engineers Journal*, vol. 3, no. 03, pp. 245–255.





## GeoProc2017

6th International Conference on Coupled THMC Processes in Geosystems  
5-7 Jul 2017 Paris (France)

### Thermo-mechanical behavior of clays explained from the nanoscale

L. Brochard<sup>1</sup>, T. Honorio<sup>1</sup>, M. Vandamme<sup>1</sup>, I. Stefanou<sup>1</sup>, S. Ghabezloo<sup>1</sup>, M. Bornert<sup>1</sup>, M. Peigney<sup>1</sup>

*Keywords: clay, thermo-mechanics, water adsorption, molecular simulation, micromechanics*

The thermo-mechanical behavior of clays is known to be quite unusual (Fig. 1). Under drained conditions, normally consolidated clays exhibit an irreversible thermal contraction, whereas over-consolidated clays exhibit a reversible thermal expansion at small temperature, followed by an irreversible thermal contraction at high temperature. In the later case, the transition from expansion to contraction occurs at a critical temperature that increases with over-consolidation. Accordingly, over-consolidation is a key property regarding the thermo-mechanics of clays.

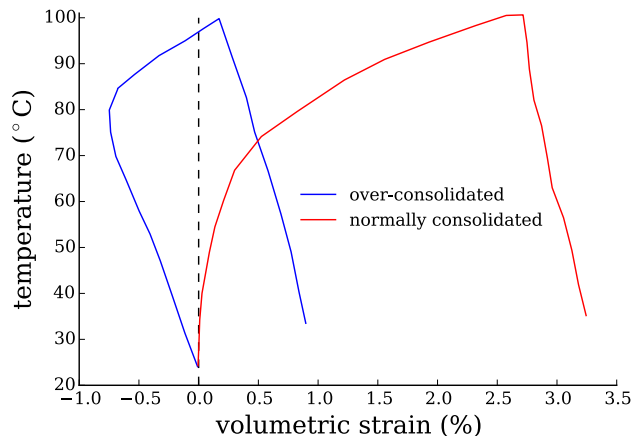

Figure 1. Volumetric deformation of Boom clay under thermal loading at constant confining stress and water pressure (adapted from Sultan et al. 2002).

The amplitudes of thermal expansion ( $\sim 10^{-4} \text{ K}^{-1}$ ) and thermal contraction ( $\sim 10^{-3} \text{ K}^{-1}$ ) are much larger than that of conventional solids and are closer to that of liquid water ( $2 \cdot 10^{-4} \text{ K}^{-1}$  at 300 K). Accordingly, the unusual behavior of clays is usually attributed to the water, and in particular to adsorbed water which is known to significantly influence the mechanics (clay deformation under humidity changes). However, the fundamentals of clay thermo-mechanics are still poorly understood (relationship between adsorption and over-consolidation? Origin of irreversibility?), and current THM models of clays are mostly macroscopic and phenomenological and do not rely on a description of

<sup>1</sup> Laboratoire Navier, UMR 8205, Ecole des Ponts, IFSTTAR, CNRS, UPE, Champs-sur-Marne, France, [laurent.brochard@enpc.fr](mailto:laurent.brochard@enpc.fr)

adsorption at the nanoscale. In this work, we propose to relate the macroscopic behavior of clays to the adsorption-induced mechanics of clay layers at the nanoscale.

At the nanoscale, clays are made of mineral layers separated by confined water. Confinement forces the water molecules to adopt a layered structure and exert a mechanical stress on the minerals that depends strongly on the basal spacing and can be much larger than the bulk pressure. The mechanical response of drained clay layer is ‘oscillating’ with deformation (see Fig. 2) and accordingly there exist ‘forbidden’ (unstable) deformations. (Meta-)stable deformations correspond to a finite number of water layers (0W, 1W, 2W etc.), which we can be viewed as different ‘phases’ of the material.

At the scale of  $\sim 100$  nm, stacks of a few tens of clay layers form particles. Particles with varying orientations aggregate together to form a matrix at the micrometer scale. A clay rock is made of such a matrix mixed with mineral inclusions (silica, carbonate etc.). To relate the mechanics of clay layers to the mechanics of the rock, we follow an upscaling strategy inspired by the theory of shape memory alloys: as in martensitic materials, different phases ( $xW$ ) can coexist in a stack of clay layers. Thus, the mechanics of a stack follows the convexified free energy of a single layer, which give rise to apparent plasticity. This approach is enriched to account for metastability and homogenized to the rock scale with a self-consistent scheme.

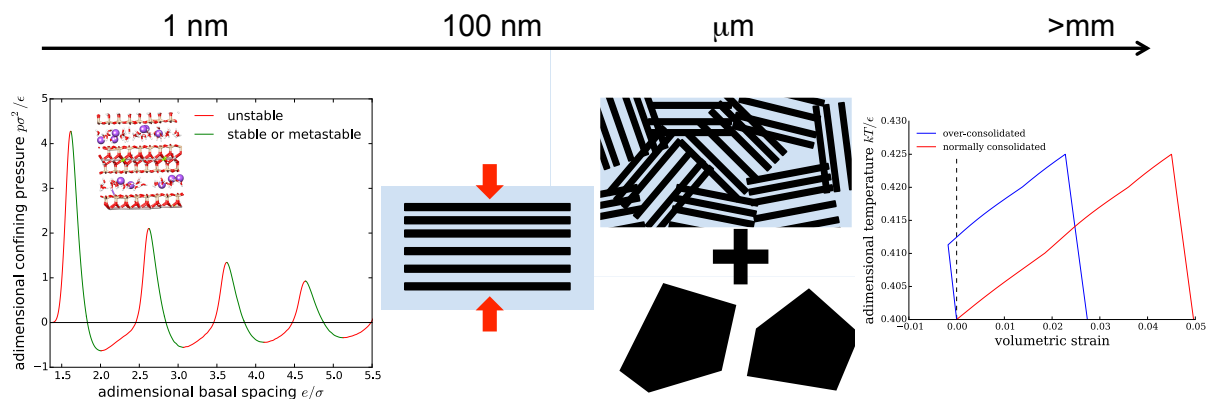

Figure 2. At the nanoscale, the mechanics of clay layers is controlled by water adsorption and exhibits different ‘phases’ corresponding to the number of water layers between mineral particles. At the scale of a stack of layers or particle, different phases can coexist which give rise to an apparent plasticity.

Up-scaling to the rock scale is performed with usual homogenization schemes that account for the distribution of orientation of clay particles and for the presence of mineral inclusions. The resulting mechanical model exhibits the same unusual thermo-mechanics as that observed in experiments on clays.

This upscaling approach leads to a thermo-mechanical behavior that captures all the features of the known thermo-mechanics of clays: reversible expansion / irreversible contraction depending on over-consolidation, increase of the expansion branch with over-consolidation, no effect of the magnitude of confining stress. This points to the importance of nanoscale adsorption in the thermo-mechanics of clays and call for a modeling of clay THM behavior based on the fundamentals of adsorption at the nanoscale.

## References

Sultan, N., Delage, P., and Cui, Y. J. (2002). Temperature effects on the volume change behaviour of Boom clay. *Engineering Geology*, 64(2-3), 135-145, doi:10.1016/S0013-7952(01)00143-0



## GeoProc2017

6th International Conference on Coupled THMC Processes in Geosystems  
5-7 Jul 2017 Paris (France)

### **A multiscale numerical modeling of elastoplastic behavior of saturated double porous geomaterials**

Y.J.CAO<sup>1</sup>, W.Q.SHEN<sup>2</sup>, J.F.SHAO<sup>3</sup>

*Keywords: Double porosity, Saturated, FFT homogenization, Micromechanics*

**Abstract:** In this paper, a micro-macro multiscale study is proposed to describe the poromechanical behavior of saturated double porous geomaterials. The two populations of pores in the studied materials are separated at two different scales and saturated by two pore pressures. Due to the small size of pores at the microscopic scale, we assume that these micro pores are of spherical shape and the solid phase at the microscopic scale is assumed to obey to a Drucker-Prager type criterion (Figure 1). The yield criterion established in Shen et al. (2016) will be adopted for the first homogenization step to determine the effective poroplastic porous matrix. In the second transition from mesoscale to macroscale, the Fast Fourier Transform technique proposed by Moulinec and Suquet (1994, 1998) will be used by considering the mesoscopic pore pressure  $q$ . Taking advantage of the FFT method, no mesh is needed in the RVE and arbitrary pore shape and distribution can be considered at the mesoscopic scale. With the two steps of upscaling, the influences of micro pore pressure  $p$  and the meso one  $q$  on the macroscopic behavior of saturated double porous geomaterials can be taken into account with drained and undrained condition. Then, the proposed model is applied to a porous rock and validated by the comparisons between the numerical results and experimental data.

---

<sup>1</sup> Laboratory of Mechanics of Lille (LML), University of Lille, 59655 Villeneuve d'Ascq, France.  
Email:caoyajun0923@gmail.com

<sup>2</sup> Laboratory of Mechanics of Lille (LML), University of Lille, 59655 Villeneuve d'Ascq, France.  
Email:wanning.shen@polytech-lille.fr

<sup>3</sup> Laboratory of Mechanics of Lille (LML), University of Lille, 59655 Villeneuve d'Ascq, France.  
Email:jianfu.shao@polytech-lille.fr

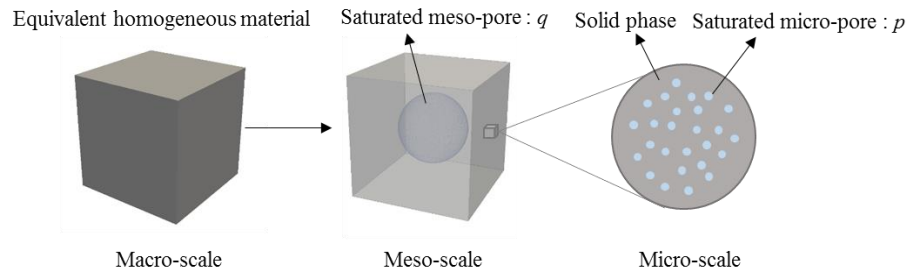

Figure 1. The RVE of the studied double porous material at different scales ( $p$ : pore pressure in micro-pore;  $q$ : pore pressure in meso-pore)

## References

- Moulinec, H., & Suquet, P. (1994). A fast numerical method for computing the linear and nonlinear mechanical properties of composites. *Comptes rendus de l'Académie des sciences. Série II, Mécanique, physique, chimie, astronomie*, 318(11), 1417-1423.
- Moulinec, H., & Suquet, P. (1998). A numerical method for computing the overall response of nonlinear composites with complex microstructure. *Computer methods in applied mechanics and engineering*, 157(1), 69-94.
- Shen, W. Q., Zhang, J., Shao, J., Kondo, D., 2016. Approximate macroscopic yield criteria for Drucker-Prager type solids with spheroidal voids, submitted.



## GeoProc2017

6th International Conference on Coupled THMC Processes in Geosystems  
5-7 Jul 2017 Paris (France)

### Flexible parallel implicit modelling of fractured reservoirs

*M. Cacace<sup>1</sup>, A.B. Jacquy<sup>1,2</sup>, G. Blöcher<sup>1</sup>, H. Milsch<sup>1</sup>, F. Deon<sup>3</sup>, M. Scheck-Wenderoth<sup>1,2</sup>, E. Huenges<sup>1</sup>*

*Keywords: THM coupled processes, FEM modelling, fractured reservoirs*

In this study, we present an overview of recent and ongoing efforts to develop a robust, yet efficient multi-physics and multi-component porous media modelling framework applicable to reservoir applications. We rely on numerical approaches to characterize interactions among thermal, hydraulic, mechanical, and ultimately chemical processes across relevant time and length scales of interest to applications including extraction of geothermal heat and fossil energy as well as storage of water, carbon dioxide, nuclear waste and thermal energy.

Based on the MOOSE (Multiphysics Object Oriented Simulation Environment, Gaston et al., 2009), we have developed a numerical simulator to solve, in a tightly implicit manner the governing equations for groundwater flow, heat and non-reactive mass transport by including poro-thermo-elastic, viscous and plastic deformation processes and their non-linear feedbacks. Equations of State (EOS) for relevant fluid properties (density and viscosity) as based on the latest IAPWS (International Association for the Properties of Water and Steam) 2008 release as well as structure-property (poro-perm) relations are also considered to close the systems of equations. The simulator is interfaced to an in-house developed geometric/meshing software (MeshIt, Cacace and Blöcher, 2015) which enables the integration of details of the three-dimensional geological architecture of real case reservoirs into a consistent Finite Element/Volume representation. Interface FEM elements are used to represent all components, that is, 3D reservoirs units, 2D faults and fractures, 1D boreholes and 0D localized sources. The resulting equations are homogenized relying on the concept of effective (hydro-mechanical) aperture for the lower dimensional elements (i.e. fractures and wells) which therefore ensure local mass and energy conservations as well as continuity of the problem variables (pore pressure, temperature and matrix displacements) across all elements interfaces.

The flexibility of the software for the (up)scale of reservoirs is discussed by presenting results obtained for the Groß Schönebeck geothermal facility, Germany (see Figure 1). In a first study case, THM simulations of the reservoir behaviour during injection and production are discussed. The aim of this study is to quantify how existing fault zones

<sup>1</sup> GFZ – German Research Centre for Geosciences, Potsdam Germany, [mauro.cacace@gfz-potsdam.de](mailto:mauro.cacace@gfz-potsdam.de)

<sup>2</sup> RWTH – Aachen University, Aachen Germany

<sup>3</sup> Delft University of Technology, Delft The Netherlands

and induced fractures affect the overall productivity and long-term sustainability of the system.

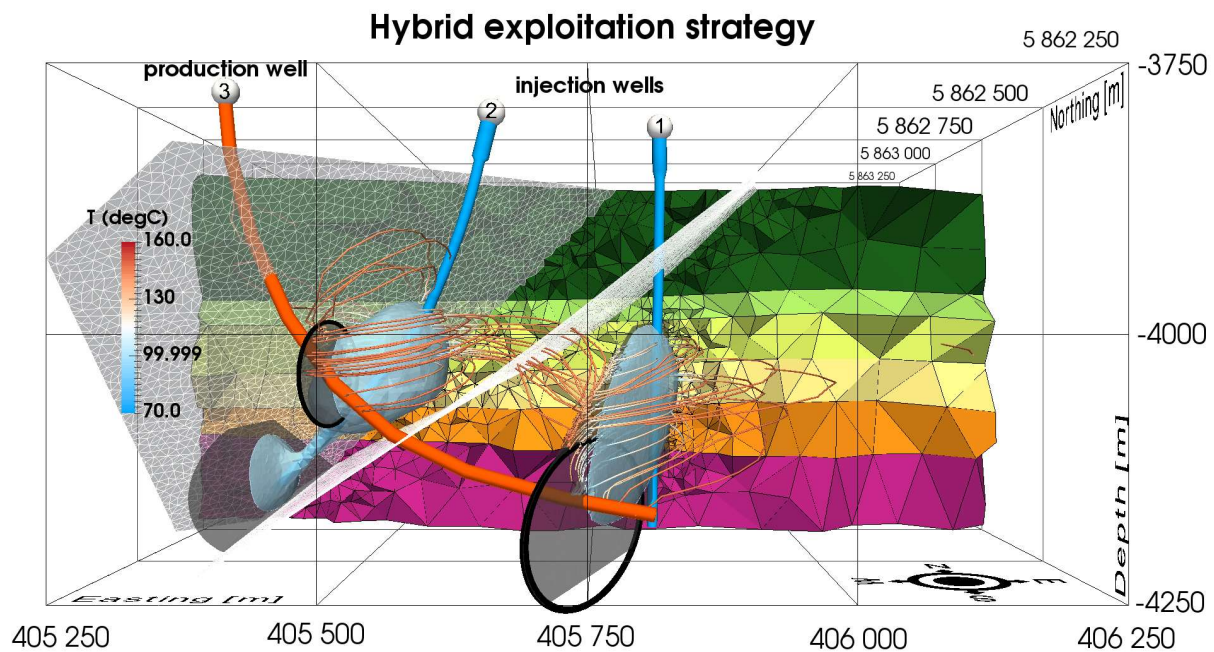

Figure 1. Example of results obtained from a simulation of the Groß Schönebeck geothermal reservoirs illustrating the evolution of the breakthrough temperature together with flowlines after approximately 30 yrs.

The second part opens a discussion on ongoing studies, in which we aim at improving the understanding of the processes responsible for micro-cracking and strain localisation. The model formulation will be briefly presented. It considers a damage intensity variable to take into account the organization of micro defects and appropriate elasto-viscoplastic constitutive equations to simulate the hardening and softening of the elastic stiffness of the porous rock. Localization of the deformation is modelled by introducing a viscous component non-linearly dependent on the rate and amount of damage accumulated throughout the loading history of the rock and a stress-dependent viscosity. Hydro-mechanical coupling is also integrated via appropriate porosity and permeability dependencies as constrained by laboratory triaxial tests under controlled p-T conditions combined with microstructural analysis of the post-mortem samples. We will end the contribution by addressing planned activities to extent the current model formulation to non-isothermal loading conditions and, possibly, by considering secondary effects related to mineral dissolution on the rock mechanical strength and flow behaviour.

## References

- Gaston, D., Hansen, G., and Newman, C. (2009), MOOSE: A parallel computational framework for coupled systems of nonlinear equations, *International Conference on Mathematics, Computational Methods & Reactor Physics*.
- Cacace, M., and G. Blöcher (2015), MeshIT – A software for three-dimensional geometric modelling of faulted reservoirs, *Environmental Earth Sciences*, 74(6), 5191–5209.



## GeoProc2017

6th International Conference on Coupled THMC Processes in Geosystems  
5-7 Jul 2017 Paris (France)

### Vaporization of fault water during seismic slip

J. Chen<sup>1,2</sup>, A.R. Niemeijer<sup>1</sup>, L. Yao<sup>2</sup>, S. Ma<sup>2</sup>, P.A., Fokker<sup>1</sup>

*Keywords: Coseismic THMC modeling, Phase transition, Slip-weakening mechanism*

In natural earthquakes, faults are expected to be subjected to water-saturated conditions, especially for the shallow portions where the principal slip zones usually consist of porous gouge material. For water-saturated gouges, derived from fault rocks or landslides, thermal pressurization of pore water was generally inferred to be the dominant mechanism controlling dynamic slip weakening [e.g. *Faulkner et al.*, 2011], although the state of the pore water (liquid or gaseous) and its role in causing the weakening is poorly understood. Numerical modeling of natural earthquakes shows that the local pressure-temperature conditions inside the slip zone can vary through a large range during faulting, and the pore water may undergo multiple phase changes, from the liquid to supercritical states or to the vapor gaseous form [*Sulem et al.*, 2007]. Water vaporization is thus expected to be important since it may affect the propagation of seismic slip and the energy budget associated with an earthquake, especially for the shallow depths temperatures in faults are measured right after an earthquake by drilling boreholes and which are used to infer the apparent dynamic frictional strength of the slipping zone of the fault during the earthquake.

In this work, we examine whether water vaporization occurs in a water-saturated gouge layer during seismic slip and whether it affects the slip weakening process, by performing both laboratory and numerical experiments. By making a small change to the sample assembly typically used in high velocity (HV) friction experiments, we are able to measure the in-situ temperature and pore pressure evolution as a function of radial position during the high-speed slip (Figure 1a). Experiments showed the development of a temperature plateau beyond 100°C, contemporaneous with the dynamic slip weakening, and consistent with thermodynamic considerations of ongoing vaporization of porewater (Figure 1b). Upon pore fluid vaporization, the pore pressure increases while the temperature is buffered endothermically, such that the porewater moves along the liquid-vapor transition curve in a pressure-temperature phase diagram (Figure 1c).

We propose a two-phase mixture model for simulating the thermal-hydrological-mechanical-chemical processes associated with a natural earthquake, including the phase transition of pore water. The results show that there is a sharp slip weakening of apparent friction coefficient upon the onset of vaporization (Figure 1d) and the P-T state

---

<sup>1</sup> HPT Laboratory, Department of Earth Sciences, Utrecht University, the Netherlands, j.chen3@uu.nl

<sup>2</sup> State Key Laboratory of Earthquake Dynamics, Institute of Geology, China Earthquake Administration

of pore water evolves along the saturated vapor curves until reaching the critical point (Figure 1e).

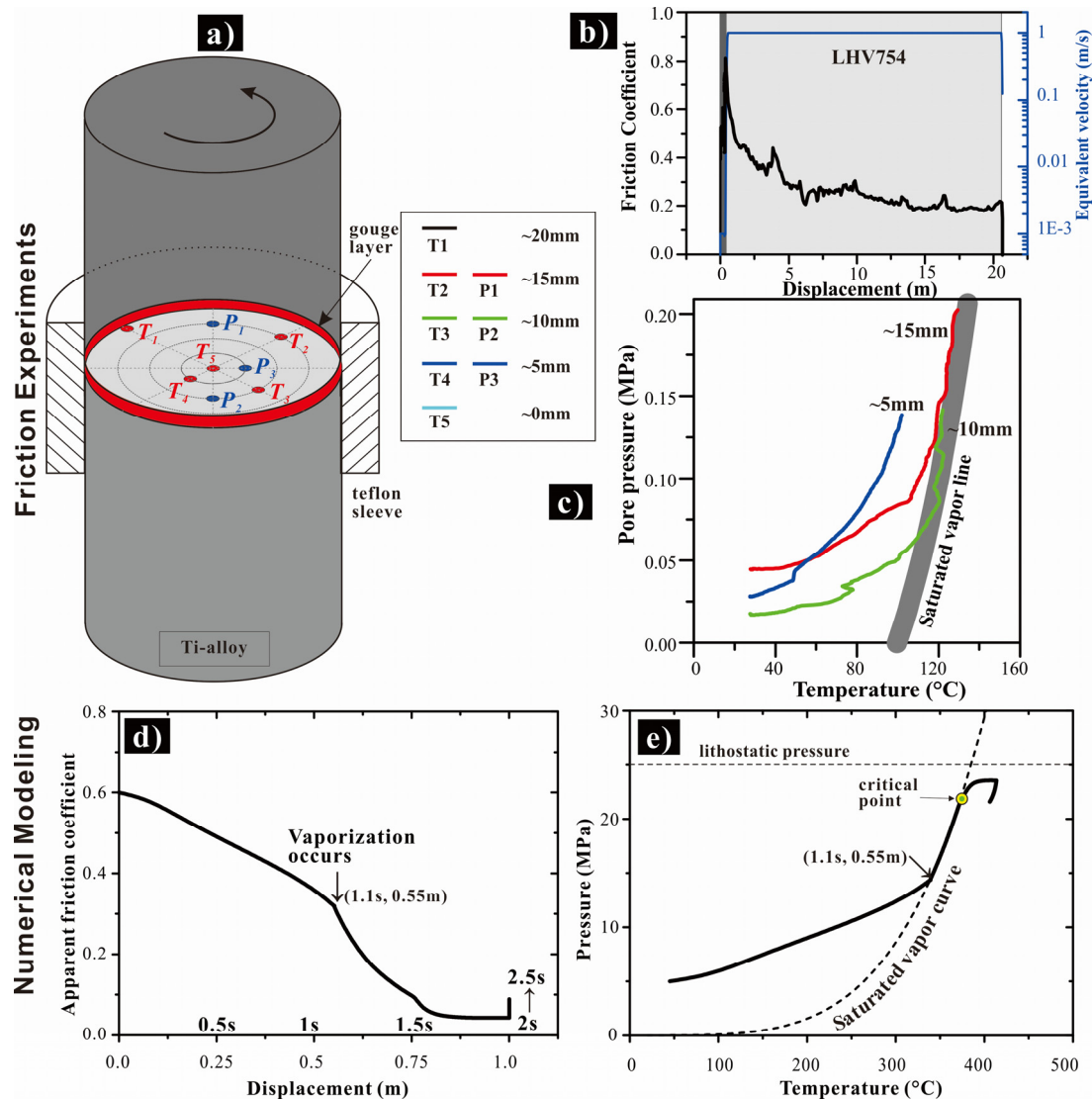

Figure 1. a)-c) High velocity friction experiment employing a new assembly which allows for the measurements of in-situ temperature and pore pressure during a seismic slip. d)-e) Numerical modeling of a seismic slip at 0.5m/s at 1 km depth of a natural fault zone (see details in the text).

We conclude that pore fluid phase transitions of this kind are expected to occur in natural earthquakes at relatively shallow crustal levels, enhancing fluid pressurization while impeding the achievement of high temperatures. This has direct consequences for the estimate of dynamic friction from downhole temperature measurements obtained shortly after a large earthquake.

## References

- Sulem, J., P. Lazar, and I. Vardoulakis (2007), Thermo-Poro-Mechanical Properties of Clayey Gouge and Application to Rapid Fault Shearing, *Int. J. Num. Anal. Meth. Geomechanics*, 31(3), 523–540.
- Faulkner, D.R., T.M. Mitchell, J. Behnen, et al. (2011), Stuck in the mud? Earthquake nucleation and propagation through accretionary forearcs, *Geophys. Res. Lett.*, 38, L18303.





## GeoProc2017

6th International Conference on Coupled THMC Processes in Geosystems  
5-7 Jul 2017 Paris (France)

### **Inverse Proportionality Between Energy Intensities and their Consequences**

*G. D. Couples<sup>1</sup>*

*Keywords: energy forms, energy quantities*

It is fairly simple to calculate the THMC forms of energy that are contained in a rock mass, but some common deformation processes seem to operate in such a way that the smallest forms of energy can have the greatest impact. Such behaviour occurs because, in geomaterials, emergent phenomena arise from very local effects. The use of un-enriched continuum descriptions may seriously mask the important fundamentals.

Consider a cubic metre of typical rock, such as a sandstone (10% porosity), located at 2km depth. Except in truly unusual conditions, we can derive reasonable estimates of temperature, stress, fluid pressure, and porefluid chemical concentrations. Referenced to a surface condition where the temperature is assumed to be 5C, the cubic metre of rock, at 65C, contains about 1.2e8J of thermal energy in its mineral frame and its porefluid. The continuum-based elastic mechanical energy of the mineral frame is determined as  $W=1/2\sigma\varepsilon=1/2\sigma^2/E$  (written in 1D, with  $\sigma$  for stress and  $\varepsilon$  for strain, and E is the stiffness). Using reasonable rock parameters, the elastic mechanical energy is about 3e5J, which is much less than 1% of the quantity of thermal energy. The thermo-elastic energy (assuming no horizontal strain) is about 2/3 of the quantity of the elastic energy itself. Energy in the porefluid (hydrostatic) is about 8e-4J, about 9 orders smaller than the frame mechanical energy. Chemical energy is often an even smaller number, by several orders, based on common solute types and concentrations. Over 99% of the energy is in the form of heat, with chemical energy being more than 12 orders smaller. Even if we consider conditions which are able to cause permanent changes (plastic yielding), the relative magnitudes of the energy forms remain the same.

The hypothetical rock has already experienced non-elastic consolidation, and cementation, with some energy consumed in these plastic and permanent material changes, which allow the current state to exist. If we consider a new loading – here, for simplicity, let us assume that this is an imposed mechanical strain – the stress state will be altered, perhaps in a way that favours localisation (a common rock response). Grains and cements, located within a tiny fraction of the volume, will be broken within the shear band that we assume to develop. Some of the pre-breakage elastic energy inside these grains/particles is converted to heat, and some to

<sup>1</sup> Heriot-Watt Univ, Edinburgh, g.couples@hw.ac.uk

acoustic waves that both leave the domain but also get “absorbed” locally in ways that may generate more heat or other consequences. The fluid energy plays a role in this deformation via the notion of effective stress, even though the fraction of the energy budget associated with the fluid is quite small. If we assume that the initial chemical potential energy is associated with species that may react with the fresh surfaces that are created by breakage, the resulting precipitation or dissolution of solid is an example of the conversion of chemical energy into changes of the material state, with potentials for feedbacks. That feedback may be of the type that causes a runaway via degradation of the solid components, or it may alter the texture of the band in a way as to cause (local) hardening by deposition of solid mass. Observations of nature’s experiments show both outcomes. Perhaps, instead, or perhaps later, the material evolves in such a way as to allow the development of longer and connected open fractures. Then, the increased effective permeability could allow thermal convection to transport heat. But without such assistance from deformation, and then flow and chemicals, the largest store of energy (heat) is essentially fixed in space.

The THMC energy potentials of geomaterials have effects that can operate, in some situations, in ways that are approximately inversely proportional to the absolute magnitudes of the energy forms. If we consider how one phenomenon may interact with others, this can lead to systems that grow in size and thus spatial impact. Can those interactions be captured appropriately in traditional continuum-based material laws? It seems difficult to imagine how to do that, if we ignore the fact that actions can be (and mostly are) highly localised in geomaterials. Nevertheless, via enriched-continuum laws, it may be possible to capture these effects. It may also be feasible to employ multi-scale methods that retain the small-scale details that matter. Regardless, it is important that any material laws or related expressions are properly balanced in terms of energy, and energy conversions.

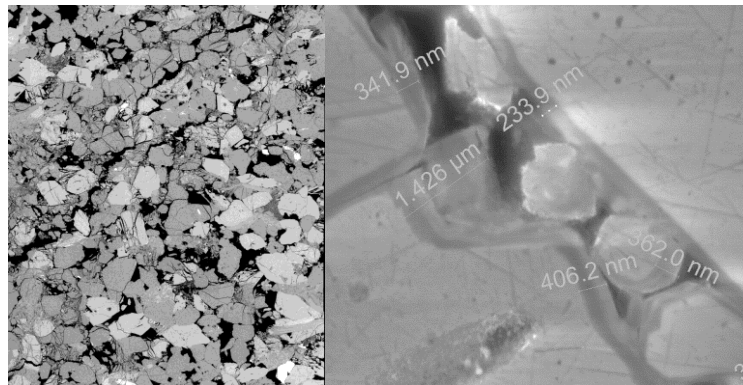

Figure 1. SEM images of deformed sandstones (courtesy of Jim Buckman). Left image depicts part of experimental shear band (from work of Elma Charalampidou), with no cement growth during deformation (field of view ~3mm). Right image shows nano-crystals of quartz cementing broken grain fragments in natural shear band.



## GeoProc2017

6th International Conference on Coupled THMC Processes in Geosystems  
5-7 Jul 2017 Paris (France)

### **Superposition of processes may explain post-injection seismicity in deep geothermal systems**

*S. De Simone*<sup>\*123</sup>, *J. Carrera*<sup>23</sup>, *V. Vilarrasa*<sup>23</sup>

*Keywords: THM coupling, post-injection earthquakes, enhanced geothermal systems, slip stress transfer, stress tensor rotation.*

Induced (micro)seismicity represents a big concern relating to deep injection activities, such as geothermal energy production, CO<sub>2</sub> injection, waste water disposal. In this study, we address the case of deep geothermal systems, in which seismicity often occurs after the end of the injection operations. Though the basic underlying processes seem to be understood, the cause of this post-injection induced seismicity still remains unclear. We conjecture that the key to explain this delayed seismicity lies in the superposition of different processes, each one affecting the stress equilibrium at different time scale.

We consider three principal processes: fluid pressure increase, temperature decrease and activation of shear slip. In deep geothermal systems, the working fluid will circulate through fractures and fault zones that have hydraulic and mechanical properties different from those of the rock matrix. The presence of these fractures or fault zones provokes non-trivial variation of the stress field, in response to both pressure and temperature perturbations. The result is that some fractures are stabilized, while others destabilized (Fig.1).

On the other hand, activation of earthquakes in the form of shear slip causes stress redistribution, which in turn affects stability in the neighborhood. As a result of these stress changes, post-injection seismicity may occur on unfavorably oriented faults that were originally stable, remained so by the superposition of the effects caused by shear

---

\* silviadesi@gmail.com

<sup>1</sup>Institute of Environmental Assessment and Water Research (IDAEA-CSIC), Barcelona, Spain

<sup>2</sup> Dept.of Civil and Environmental Engineering, Universitat Politècnica de Catalunya (UPC), Barcelona, Spain

<sup>3</sup>Associated Unit: Hydrogeology Group (UPC-CSIC)

slip, temperature and pressure forcing, but become unstable when the latter dissipates after injection stops.

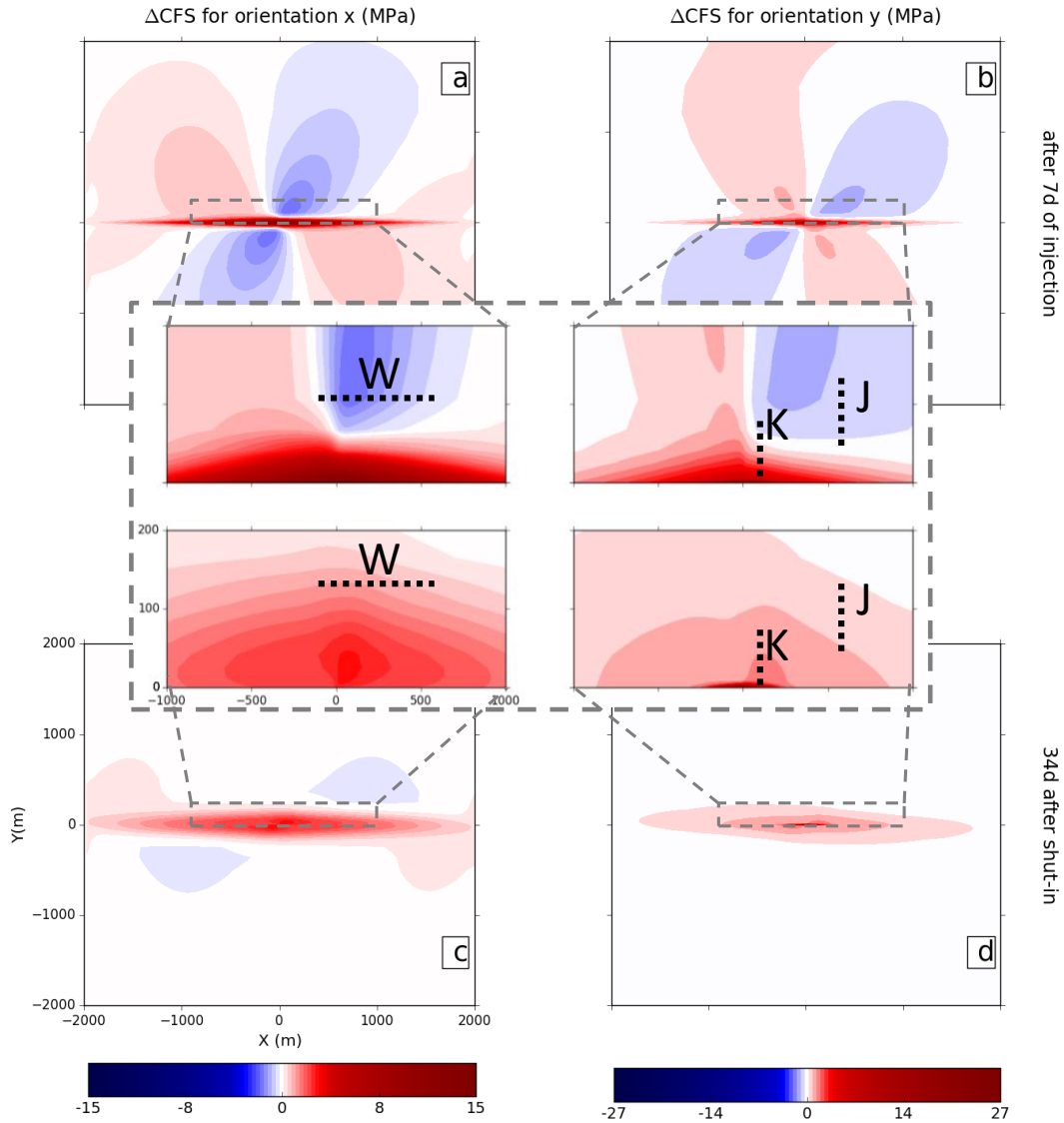

Figure 1. Variation of Coulomb Failure Stress ( $\Delta CFS$ ) due to the sum of hydraulic and thermal effects in the (a) x- and (b) y-direction after 7 days of injection and in the (c) x- and (d) y-direction at 34 days after the shut-in. The close-ups focus on the observation regions W, J and K. The dashed black lines indicate fractures that are stabilized during injection and destabilized in the post-injection period.



## GeoProc2017

6th International Conference on Coupled THMC Processes in Geosystems  
5-7 Jul 2017 Paris (France)

### Chemical Control of Fracture Permeability, Injectivity, and Reservoir Sweep in Geologic CO<sub>2</sub> Storage

*T. Dewers<sup>1</sup>, C. Choens<sup>2</sup>, B. Gabis<sup>3</sup>, M. Wheeler<sup>4</sup>*

*Keywords: Carbon capture and storage, fracture, localization, permeability*

#### Introduction

Subsurface engineering for waste storage or resource extraction aims for desirable and controllable outcomes. In geologic carbon storage (GCS), these include using pore space with unprecedented efficiency, sustaining injectivity over the lifetime of an injection project, and avoiding unwanted or emergent risky consequences. We discuss field, experimental, and modeling examples of these and discuss challenges posed for research, development, and implementation for controllable GCS. For example, observed changes in reservoir response accompanying CO<sub>2</sub> injection at the Cranfield (Mississippi, USA) site, along with a suite of lab tests, shows potential for use of injectate chemistry as a means to alter fracture permeability (with concomitant improvements for sweep and storage efficiency).

#### Results

Laboratory experiments guide the development of thermal-hydrological-chemical-mechanical constitutive relationships that couple changes in pore fluid chemistry, fracture propagation, and permeability evolution during CO<sub>2</sub> injection. Figure 1 below shows results of triaxial compression experiments conducted using Boise Sandstone (Tertiary, USA) and Tuscaloosa Sandstone (Cretaceous, USA; from Rinehart et al., 2016) with varying pore fluid chemistry. Dry and water wet Boise, and the 'B' and 'C' lithofacies of the Tuscaloosa Sandstone at the Cranfield Site containing CO<sub>2</sub>-equilibrated brine, all follow a similar failure surface plotted in stress invariant space (in Figure 1  $(J_2)^{1/2}$  is the second invariant of the deviatoric stress tensor, and  $I_1$  is the first invariant of the stress tensor). The red band in Figure 1 shows estimated range in in situ stresses. The Boise Sandstone is slightly weakened (a lesser slope of the failure surface, black dots) when exposed to wet scCO<sub>2</sub>, as compared to dry, water-wet, and dry CO<sub>2</sub> pore fluids. However, a chlorite-bearing facies of the Tuscaloosa (Rinehart et al., 2016) shows a marked weakening below in situ stress levels when subject to a pore fluid brine phase equilibrated with scCO<sub>2</sub>. We conjecture that such chemical-

<sup>1</sup> Sandia National Laboratories, Albuquerque, New Mexico, USA, [tdewers@sandia.gov](mailto:tdewers@sandia.gov)

<sup>2</sup> Sandia National Laboratories, Albuquerque, New Mexico, USA, [rcchoens@sandia.gov](mailto:rcchoens@sandia.gov)

<sup>3</sup> Center for Subsurface Modeling, ICES, The University of Texas at Austin, Austin, Texas, USA, [bganis@ices.utexas.edu](mailto:bganis@ices.utexas.edu)

<sup>4</sup> Center for Subsurface Modeling, ICES, The University of Texas at Austin, Austin, Texas, USA [mfw@ices.utexas.edu@email.com](mailto:mfw@ices.utexas.edu@email.com)

related weakening modified the permeability field at Cranfield, as presumed in the injection-pressure history. Thus, knowledge of heterogeneity (locations of chemistry-susceptible rock types) and injectate chemistry, in this case at Cranfield, could be seen as measures of control of subsurface permeability and, arguably, stimulating injectivity and potentially improving reservoir sweep.

New coupled modeling using the University of Texas multiphase Implicit Parallel Accurate Reservoir Simulator (IPARS; Mikelic' et al., 2014) demonstrates that injection coupled with chemo-mechanical response can result in localized time-dependent stimulation including improvements in reservoir sweep and storage efficiency. Together, these examples highlight current research aimed at controlling reservoir stimulation and understanding and prevention of emergent subsurface failure modes. Three factors: injectate chemistry, pore pressure, and reservoir/caprock heterogeneity are presented as leading themes in subsurface control of process for these challenges.

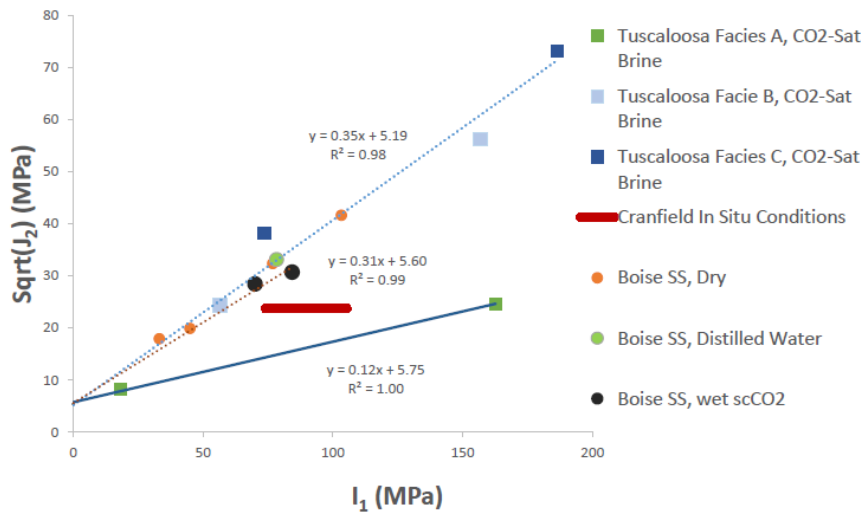

**Figure 1.** Failure surfaces in the stress space of  $(J_2)^{1/2}$  or Mises shear stress and  $I_1$ , related to mean stress. Boise and Tuscaloosa Sandstones show similar limiting failure surfaces; Boise shows slight weakening when exposed to hydrous supercritical CO<sub>2</sub> (scCO<sub>2</sub>), and the chlorite-bearing lithofacies A of Rinehart et al (2016) shows considerable weakening when exposed to scCO<sub>2</sub>-equilibrated brine.

### Acknowledgements:

This work was supported as part of the Center for Frontiers of Subsurface Energy Security (CFSES) an Energy Frontier Research Center funded by the U.S. Department of Energy, Office of Science, Basic Energy Sciences under Award #DE-SC0001114. Sandia National Laboratories is a multi-mission laboratory managed and operated by Sandia Corporation, a wholly owned subsidiary of Lockheed Martin Corporation, for the U.S. Department of Energy's National Nuclear Security Administration under contract DE-AC04-94AL85000.

### References

- Mikelic', A., Wang, B., and Wheeler, M. (2014) Numerical convergence study of iterative coupling for coupled flow and geomechanics, *Computational Geosciences*, 18, 325-341.
- Rinehart, A, Dewers, T, Broome, S, and Eichhubl, P (2016) Effects of CO<sub>2</sub> on mechanical variability and constitutive behavior of the Lower Tuscaloosa Formation, Cranfield Injection Site, USA, *International Journal of Greenhouse Gas Control*, 53, 305-318.



## GeoProc2017

6th International Conference on Coupled THMC Processes in Geosystems  
5-7 Jul 2017 Paris (France)

### **Coupled CFD-DEM simulation of slip instabilities in sheared granular layer; applications to granular fault gouge**

*O. Dorostkar<sup>1</sup>, P. Johnson<sup>2</sup>, R. Guyer<sup>3</sup>, C. Marone<sup>4</sup>, J. Carmeliet<sup>5</sup>*

*Keywords: CFD-DEM, Granular materials, Fault gouge, Shear stress*

The influence of fluids on the frictional behavior of granular layers has been a long-standing open question. The significance of this influence has been documented recently in stick-slip experiments with different saturation level [Scuderi *et al.*, 2014]. A granular layer in a fault gouge undergoes stick-slip cycles, which is thought to be the underlying mechanism of the earthquake nucleation and slip process. In order to isolate the hydro-mechanical effect of fluid on the characteristics of stick-slip cycles, we conduct coupled computational fluid dynamics (CFD) and discrete element method (DEM) simulations. We study the characteristics of slip events in a sample saturated with water i.e. the friction drop, released kinetic energy of particles and fluid and the thickness change.

Figure 1 shows a sample with 8000 spherical particles. The color-coding represents the particles released kinetic energy during a characteristic slip event. The slip patch i.e. the region where the slip happens can be clearly observed by zones with high kinetic energy (colored by red particles). We then do long simulations for both dry and fluid saturated storing information of hundreds of slip events. A statistical analysis on the released kinetic energy of slip events is presented in Fig. 2. The complementary cumulative distribution function of particle kinetic energy for dry and fluid saturated fault gouge in Fig. 2 clearly shows the influence of presence of fluids. This figure indicates that slip events are observed with larger kinetic energy in the fluid saturated model. Our preliminary grain scale observations show that the presence of fluid can stabilize the granular gouge leading to bigger recurrence time. The fluid-solid interaction forces during the slip event is thought to be the driving force for increase of kinetic energy. Our simulations show that the fluid-solid interaction forces can facilitate the slip process leading to events with higher kinetic energy. The fluid-solid coupling forces during the slip increase the particles kinetic energy leading to bigger compaction and stress drop.

---

<sup>1</sup> ETH Zürich, Switzerland, email: domid@ethz.ch

Empa – Switzerland, email: omid.dorostkar@empa.ch

<sup>2</sup> Los Alamos National Laboratory, USA, email: paj@lanl.gov

<sup>3</sup> Los Alamos National Laboratory, USA, email: guyer@physics.umass.edu

<sup>4</sup> Pennsylvania State University, USA, email : cjm38@psu.edu

<sup>5</sup> ETH Zürich, Switzerland, email: cajan@ethz.ch

Empa – Switzerland, email: jan.carmeliet@empa.ch

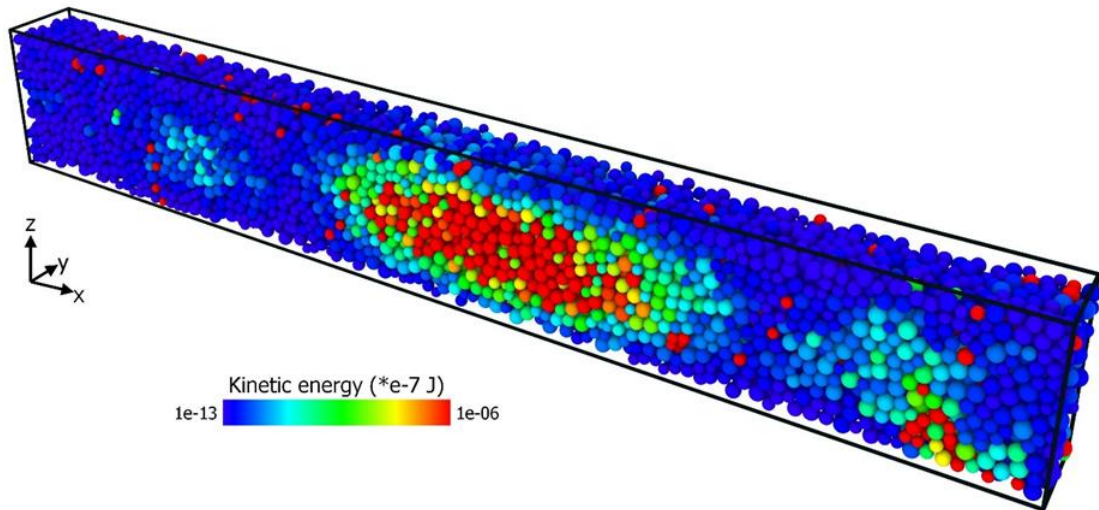

Figure 1. Kinetic energy of particles during a slip event. The slip patch is the region with particles having high kinetic energy. The sample consists of 8000 spherical particles with size of 45-75 micron. The size of the sample is 11\*0.8\*1.5 mm.

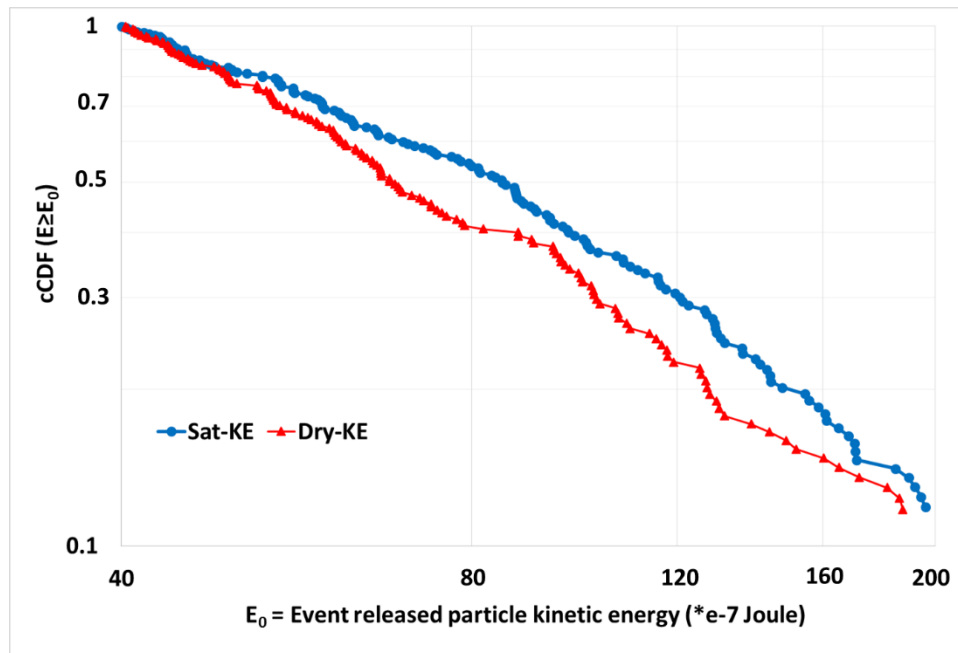

Figure 2: Complementary cumulative distribution of event size for released particles kinetic energy.

Our future works are dedicated to in-depth study of influence of fluids on the frictional behavior of granular fault gouge in grain scale. The study of spatial distribution of zones with high particle kinetic energy together with high fluid-solid interaction forces can be an asset to explain more in detail the micromechanics of stick-slip response. Our results show that the drag force that is mobilized due to high solid-fluid interaction during the slip instability is the dominant factor facilitating the increase of slip kinetic energy.

## References

Scuderi, M. M., Carpenter, B. M., & Marone, C. (2014). Physicochemical processes of frictional healing: Effects of water on stick-slip stress drop and friction of granular fault gouge. *J. Geophys. Res.*, 119(5), 4090-4105. doi:10.1002/2013jb010641.





## GeoProc2017

6th International Conference on Coupled THMC Processes in Geosystems  
5-7 Jul 2017 Paris (France)

### Micromechanical modeling of time-dependent behavior of a typical shale rock

F. Farhat<sup>1</sup>, W. Shen<sup>1</sup>, J.F. Shao<sup>1</sup>, H. Pourpak<sup>2</sup>

*Keywords: shale, multiscale, homogenization, viscoplasticity.*

In the past decade, the exploitation of unconventional shale gas reservoirs for hydrocarbon production has become common. Due to the very low permeability of the shale matrix, stimulation by hydraulic fracturing is the key to a successful production. Shale petrophysical characteristics, such as total organic carbon content, thermal maturity and porosity, influence the potential of gas production. Furthermore, a successful stimulation of a shale gas formation should be the support of several geomechanical conditions which short and long-term behavior is one of the keys. Our study focuses on predicting macroscopic instantaneous and time-dependent mechanical behavior of shale rock by developing, analytically, a multi-scale model. Compared with phenomenological models, a micromechanical model takes into account explicitly the influence of mineralogical composition on the macroscopic behavior. Shales can be considered as multiphase and multiscale material systems with intrinsic heterogeneity in mineralogy, microtexture and mechanical properties. According to petrographical observations, different scales can be identified in the microstructure of the studied typical shale (Figure 1).

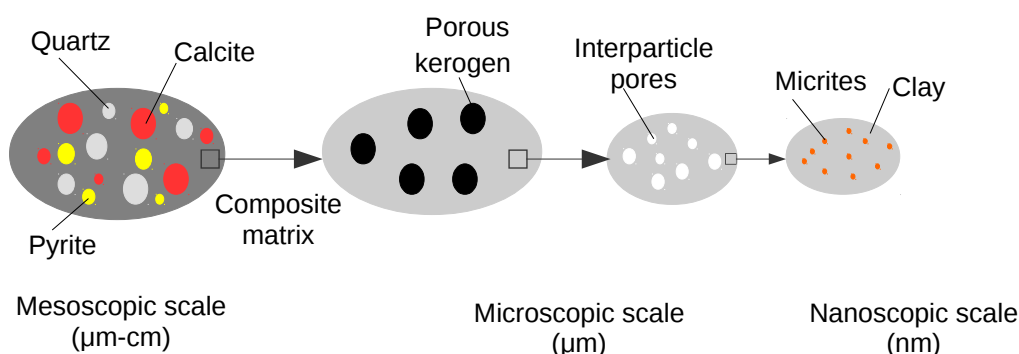

Figure 1. Microstructure of the typical shale rock.

At macroscopic scale, the material is seen homogeneous. At mesoscopic scale, quartz, calcite, albite and pyrite inclusions are seen embedded in a composite matrix. In the

1 Univ. Lille, FRE 3723-LML-Laboratoire de Mécanique de Lille, F-59000. [faten.farhat@etudiant.univ-lille1.fr](mailto:faten.farhat@etudiant.univ-lille1.fr), [wangqing.shen@polytech-lille.fr](mailto:wangqing.shen@polytech-lille.fr), [jian-fu.shao@polytech-lille.fr](mailto:jian-fu.shao@polytech-lille.fr)

2 TOTAL, Avenue Larribau, 64018 Pau Cedex, France. [hamid.pourpak@total.com](mailto:hamid.pourpak@total.com)

latter, different constituents can be distinguished at the microscopic scale: organic inclusions are immersed in a porous medium whose solid phase is reinforced by small micrite inclusions. In order to study the instantaneous and time-dependent behavior of the typical shale rock, a four-step homogenization procedure is adopted to consider the constituents effect on the macroscopic behavior. For the simplicity, the inclusions are assumed to be spherical and elastic. The meso–macro upscaling is performed by using the incremental approach initially proposed by [Hill, 1965] which allows to account for the effects of mesoscopic mineral inclusions. At the microscopic scale, the composite matrix is made up of elastic organic inclusions and a porous matrix whose clay solid phase, at the smallest scale, is reinforced by micritic inclusions. The clay solid phase is assumed obeying to the classical Drucker-Prager criterion to account for pressure sensitive property of geomaterials. The plastic criterion, established in [Ghorbanbeigi et al., 2016], will be adopted as the yield function for the description of the elastoviscoplastic deformation inside the composite matrix. Both the instantaneous and differed behavior are considered within the unique model. Comparisons between numerical simulations and experimental data show that the proposed model is able to reproduce the main features of the mechanical behavior of this material.

## References

- Hill, R. (1965), Continuum micro-mechanics of elastoplastic polycrystals, *J. Mech. Phys. Solids*, 13, 89-101, doi:10.1016/0022-5096(65)90023-2.
- Ghorbanbeigi, H., W. Shen, I. Yurtdas and J.F. Shao. (2016), A micromechanics-based model for concrete materials subjected to carbonation, *Int. J. Numer. Anal. Meth. Geomech*, 40, 1203–1218, doi: 10.1002/nag.2479.



## GeoProc2017

6th International Conference on Coupled THMC Processes in Geosystems  
5-7 Jul 2017 Paris (France)

### Progressive damage and strain localization in modelling pre-eruptive deformation: analytical and numerical results

J.-L. Got<sup>1</sup>, D. Amitrano<sup>2</sup>, A. Carrier<sup>3</sup>, D. Marsan<sup>1</sup>, F. Jouanne<sup>1</sup>, K. Vogfjörð<sup>3</sup>

*Keywords: Eruption, damage, deformation, rupture, magma-edifice coupling*

#### **A time analysis of the non-linear magma-edifice coupling at Grimsvötn volcano**

Large natural geological processes provide large data sets that may be studied using the geomechanical concepts used in engineering, and may participate to the improvements of their knowledge. On active basaltic volcanoes, continuous monitoring of seismicity and surface displacement reveals important features of the eruptive cycle. At Piton de la Fournaise volcano, based on averages performed over 22 eruptions, Schmid et al. (2012) showed that seismicity rate and displacement rate were increasing in the days and weeks preceding the eruption. At Grimsvötn volcano, high-quality earthquake and continuous GPS data were recorded and exhibit remarkable patterns : acceleration of the cumulated earthquake number, and a 2-year exponential decrease in displacement rate followed by a 3-year constant inflation rate (Figure 1). The 2-year exponential decrease in displacement rate may be explained by the pressurization of a superficial reservoir fed by magma through a cylindrical vertical conduit and may be modelled using a linear elastic model. This model however can not explain the constant inflation rate that follows, which corresponds to a constant volume increase rate, that is, a constant input magma flow. Imposing a constant magma flow condition in the reservoir in a linear elastic medium leads to the magma pressure linearly – and infinitely – increasing with time. However real rock strength is limited and rupture occurs. Rock mechanics experiments show that rupture is preceded by a damage phase, during which inelastic deformation increases, micro-rupture number accelerates, and Young's modulus decreases with strain. We show that Kachanov's elastic brittle damage law may be used, in the pre-eruptive case, to express the decrease of the effective shear modulus with time. Using this law and a simple pressurization model, we found analytical solutions for the state variables: magma reservoir overpressure, surface displacement, magma flow and strain power, in the case where magma is incompressible (Figure 1). Critical time  $t_c$  may be estimated from the fit of the seismicity model to the data, and parameters  $a$ ,  $t_0$  and  $u_{el}$  are estimated from the fit of the displacement model to the data. Results (Figure 1) show how the shear modulus decreases with time; they also show that overpressure

---

<sup>1</sup> Université Savoie Mont-Blanc, ISTerre, Le Bourget du Lac, France, [jlgot@univ-smb.fr](mailto:jlgot@univ-smb.fr)

<sup>2</sup> Université Grenoble Alpes, ISTerre, Grenoble, France, [david.amitrano@univ-grenoble-alpes.fr](mailto:david.amitrano@univ-grenoble-alpes.fr)

<sup>3</sup> Icelandic Meteorological Office, Reykjavik, Iceland, [vogfjord@vedur.is](mailto:vogfjord@vedur.is)

and magma flow remain constant for  $\sim 1000$  days, and respectively decreases and increases before the rupture and eruption. Overpressure decrease is controlled by damage and shear modulus decrease. Displacement increases, although overpressure is decreasing, because shear modulus decreases more than overpressure. Normalized strain power reaches a maximum 0.25 value. State variable extrema provide four reference times that may be used to assess the mechanical state and dynamics of the volcanic edifice. When magma is incompressible and  $t_0$  sufficiently large, the final stage of the pre-eruptive process is controlled by damage.

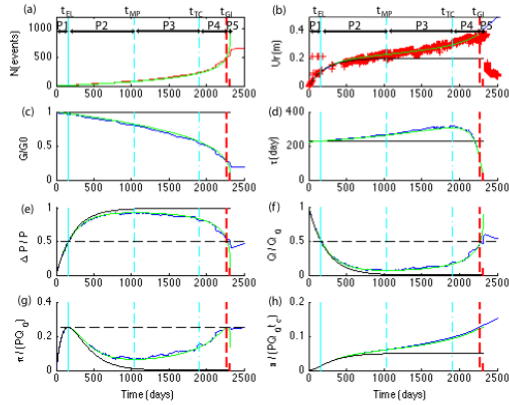

$$N(t) = -\frac{1}{c} \ln(1 - cBt) \quad (1)$$

$$\frac{G(t)}{G_0} = \left(1 - \frac{t}{t_c}\right)^a \quad (2)$$

$$\frac{1}{\tau(t)} = \frac{1}{\tau_0} \left(1 - \frac{t}{t_c}\right)^a + \frac{a}{t_c - t} \quad (3)$$

$$\frac{u(t)}{u_{el}} = \alpha^{1-s} \left( \gamma(s, \alpha) - \gamma \left( s, \alpha \left(1 - \frac{t}{t_c}\right)^{a+1} \right) \right) e^{\alpha \left(1 - \frac{t}{t_c}\right)^{a+1}} \quad (4)$$

$$\frac{\Delta P(t)}{P} = \alpha^{1-s} \left(1 - \frac{t}{t_c}\right)^a \left( \gamma(s, \alpha) - \gamma \left( s, \alpha \left(1 - \frac{t}{t_c}\right)^{a+1} \right) \right) e^{\alpha \left(1 - \frac{t}{t_c}\right)^{a+1}} \quad (5)$$

$$\frac{Q(t)}{Q_0} = 1 - \frac{\Delta P(t)}{P} \quad (6)$$

$$\frac{\Pi(t)}{\Pi_0} = \frac{\Delta P(t)}{P} \left(1 - \frac{\Delta P(t)}{P}\right) \quad (7)$$

Figure 1. Model variables as a function of time from 01/12/2004 to 31/12/2011. Data are represented in red, Runge-Kutta (RK) numerical solution in blue, analytical solution in green, linear elastic solution in dashed black.  $t_c$  is estimated from  $N(t)$ ,  $t_0$ ,  $u_{el}$  and  $a$  from  $u(t)$ .  $g$ : incomplete  $g$  function.

## Damage and strain localization around a pressurized magma reservoir

When a rock sample is submitted to increasing stress, damage appears and strain progressively localizes. We used finite element modelling of an initially elastic volcanic edifice pressurized by a spherical magma reservoir, and Kachanov's damage law to decrease the effective modulus of each element with strain. A complex strain localization pattern appears (Figure 2).

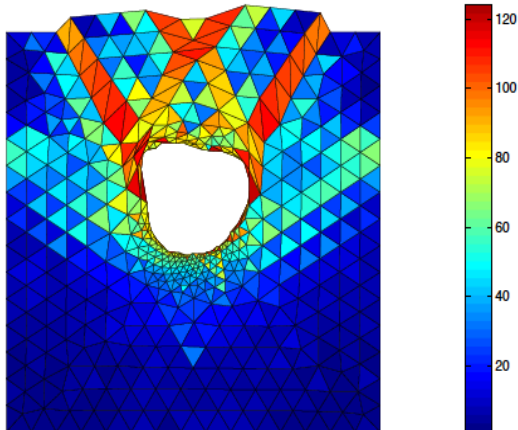

Figure 2: Number of ruptures per cell, in a 2D finite element model showing the deformation of a volcanic edifice pressurized (constant pressure) by an initially circular magma reservoir (no horizontal displacement of the model vertical boundaries). Modeling follows Amitrano et al. (1999)'s algorithm: rupture in a cell occurs when the Mohr-Coulomb criterion is fulfilled; the corresponding effective modulus is decreased. Damage and strain localization occur progressively. Inverse and normal faults appear, as well as an undeformed wedge just above the pressurized reservoir. This pattern is observed in analog experiments and on the field.

## References

- Amitrano, D., Grasso, J.-R., Hantz, D., 1999. From diffuse to localised damage through elastic interaction, *Geophys. Res. Lett.*, 26, 14, 2109-2112.
- Schmid, A., Grasso, J.-R., Clarke, D., Ferrazzini, V., Bachèlery, P., and Staudacher, T., 2012. Eruption forerunners from multiparameter monitoring and application for eruption time predictability, *J. Geophys. Res.*, 117, B11, 203, doi:10.1029/2012JB009167.



## GeoProc2017

6th International Conference on Coupled THMC Processes in Geosystems  
5-7 Jul 2017 Paris (France)

### Extent of Tensile Cracking Induced by a Hydraulic Fracture

*D.I. Garagash<sup>1</sup>, B. Lecampion<sup>2</sup>, and D. Liu<sup>3</sup>*

*Keywords: hydraulic fracture, rock damage, jointing, reservoir stimulated volume*

Rock damage induced by a propagating hydraulic fracture (HF) may have an important impact on the success of reservoir stimulation (enhancement of rock permeability in the damaged zone), as well as, on the cumulative resistance to the HF propagation and on its ultimate dimensions. Stress and pore pressure perturbations near the front of the propagating HF are responsible for such near-tip rock damage. The idea of that damage occurring due to the reactivation of preexisting fractures / planes of weakness is usually invoked, yet, striking observations of extensive zones of parallel tensile joints formed about the basaltic dike intruding initially *uncracked* sedimentary rock [Delaney et al, 1986], Fig. 1a, and about a hydraulic (gel) fracture propagated in a tight sandstone [Warpinski et al, 1993; Nolte, 1993], suggest that the fresh tensile rock fracture (sub)parallel to the HF plane may be at the least as important. The extent of the parallel jointing in these two examples, ~ 20 meters for the dike and ~ 1.5 meters for the HF, is much larger than the typical size of the tensile stress region expected near the tip of rock fracture when characterized by laboratory values of the rock fracture toughness.

In order to reconcile the extent and the geometry of the observed wide zones of induced fracturing around a propagating HF, we consider stress perturbation specific to a hydraulic fracture front, where the resistance to the HF propagation is predominantly due to the viscous dissipation in the fracturing fluid flow rather than due to the rock breakage, [Desroches et al., 1994]:

$$\Delta\sigma_{ij}(r, \theta) = f_{ij}(\theta)(\mu V E'^2 / r)^{1/3} \quad (1)$$

where  $r$  = the distance from the moving HF tip,  $\theta$  = the polar angle,  $V$  = the HF tip velocity,  $\mu$  = fracturing fluid viscosity,  $E'$  = plane-strain elastic modulus of the rock, and  $f_{ij}$  is  $O(1)$ . Eq. (1) predicts infinite fluid suction near the tip, and therefore the existence of a fluid lag in the fracture [Garagash and Detournay, 2000]. However, we can show that the tensile effective stress zone around the HF tip in an over-pressured reservoir is much larger than the fluid-lag size, rendering the no-lag solution, Eq. (1), appropriate.

Based on Eq. (1), we anticipate that the tensile stress perturbation of the magnitude of the least ambient compressive effective stress,  $\bar{\sigma}_0 = \sigma_0 - p_0$ , or above, (which would result in tensile total stress), persist to distances  $r_{tensile} \sim \mu V E'^2 / \bar{\sigma}_0^3$  normal to the HF

<sup>1</sup>Dalhousie University, Halifax, Canada, garagash@dal.ca

<sup>2</sup>Ecole Polytechnique Fédérale de Lausanne, Switzerland, brice.lecampion@epfl.ch

<sup>3</sup>Ecole Polytechnique Fédérale de Lausanne, Switzerland, d.liu@epfl.ch





## GeoProc2017

6th International Conference on Coupled THMC Processes in Geosystems  
5-7 Jul 2017 Paris (France)

### Implementation of a softening-healing law in a distinct element fluid injection simulation

R. Ghazal<sup>1</sup>, J. Hazzard<sup>2</sup>, F. Cappa<sup>3</sup>, C. Darcel<sup>4</sup>, Y. Guglielmi<sup>5</sup>

*Keywords: fluid injection, fracture, microseismicity, softening-healing, rate-and-state*

Microseismic events can be triggered by the injection of fluid into a discontinuous rock mass. In several applications, such as hydraulic fracturing and geothermal energy, assessing seismic hazards is of vital importance. The injection of a fluid into a fracture causes fracture opening and consequently a decrease in its effective stress, which can result in slipping. A slip becomes seismic when the drop of strength is faster than the elastic unloading of the fracture. This type of behavior could be taken into account using a strength evolution law. Researchers over the last 30 years have shown that a rate-and-state variable friction law gives the most realistic representation of fault strength evolution [Dieterich, 1972]. Incorporating such a law into a hydromechanical simulation could help assessing seismic and aseismic slip during fluid injection operations but is numerically quite challenging.

In this study, we use instead a simplified rate-and-state law; a Coulomb softening-healing law (SH-Coulomb) where the residual friction is reached at a critical slip distance  $D_c$ . The friction is restored to its peak value when the shear stress drops again below the residual envelope (Figure 1). The main objective is to evaluate the capacity of such constitutive law to account for seismic behavior observed during injection operations. A model of fluid injection into a single fracture having SH-Coulomb behavior is built using distinct element code 3DEC (Itasca, 2016). The geometry (Figure 1) and injection data are taken from in situ experiment of fluid injection directly into a fault zone (Guglielmi et al, 2015). Micro-seismicity is monitored during the injection. A slip is assumed to be seismic if shear velocity at the slipping point is higher than a threshold velocity  $V_{th}$  (in this study  $V_{th}=1\text{mm/s}$ ). When the shear velocity drops again below this threshold, the sub-event is considered finished; and corresponding normal and shear displacement are recorded as well as the sub-event duration. Sub-events can be clustered into larger macro events depending on two criteria: the distance between the sub-events and a minimum normal stress magnitude for which the event is considered to be seismic. Moment tensors and magnitudes are then calculated based on normal and shear displacements of the fracture.

<sup>1</sup> Itasca Consultants SAS, r.ghazal@itasca.fr

<sup>2</sup> Itasca Consultants Group, jhazzard@itascacg.com

<sup>3</sup> Geoazur Laboratory, cappa@geoazur.unice.fr

<sup>4</sup> Itasca Consultants SAS, c.darcel@itasca.fr

<sup>5</sup> LBNL-EESA, yguglielmi@lbl.gov

The evolution of fracture opening and slip at the injection point as well as pore pressure and injection rate are given in Figure 2. Seismic events, colored by moment magnitude are given in Figure 3. The model was run for two values of the parameter  $D_c$ . The increase of the slipping distance leads to a decrease in the seismic events magnitudes and shear displacement. Other parametric studies have shown an increase of seismic events and slip magnitudes when the rock mass is softer due essentially increase in fracture opening.

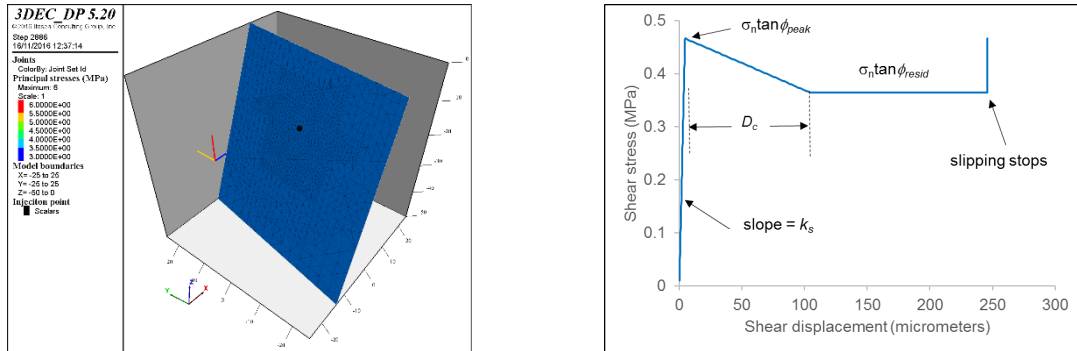

Figure 1. 3DEC model geometry and initial stresses (left) and schematic representation of the SH-Coulomb law (right).

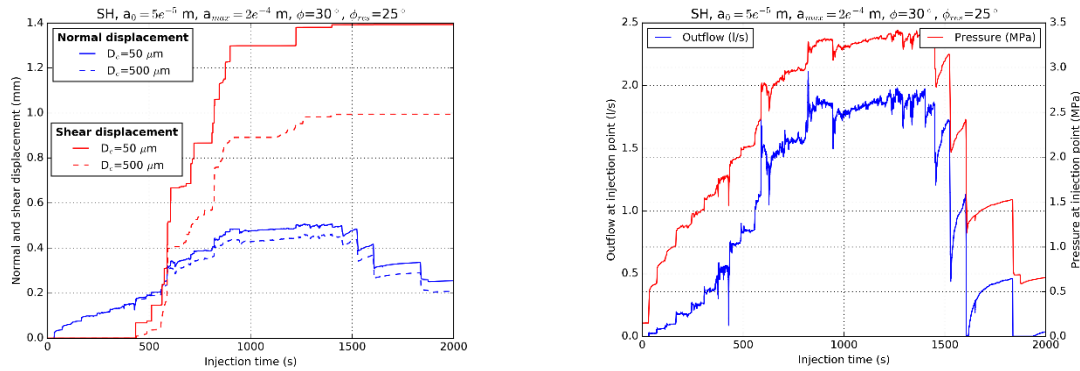

Figure 2. Evolution with time of opening and slip (left) and pore pressure and fluid flow rate (right) at the injection point.

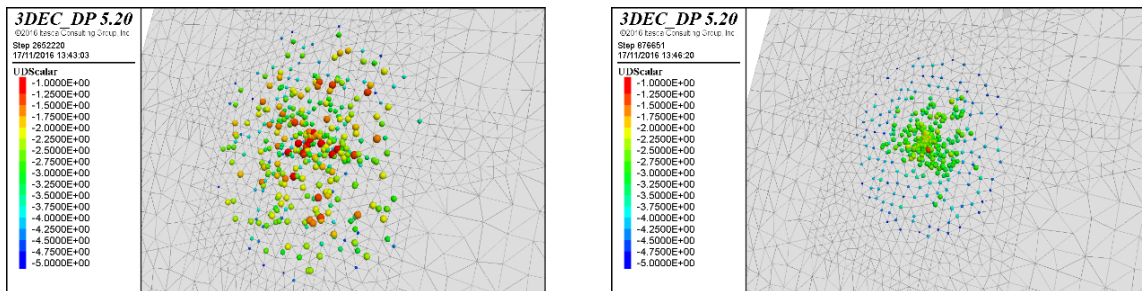

Figure 3. Micro-seismic events magnitudes at time 2000s after the injection starts for a normal stress threshold of 1.5 MPa and a distance of 1.1m,  $D_c = 50 \mu m$  (left) and  $D_c = 500 \mu m$  (right).

This study shows that seismic events can be generated in a hydro-mechanical simulation of fluid injection into a fracture by considering a simplified rate-and-state friction law. The next step would be to implement a full rate-and-state friction law into a 3DEC injection simulation and calibrate the model to field experimental results.

## References

- Dieterich, J.H. (1972), Time-dependant friction in rocks. *J. Geophys. Res* 77, 3690-3697.
- Guglielmi, Y., Cappa F., Avouac, J.P., Henry, P., and D. Elsworth (2015), Seismicity triggered by fluid injection-induced aseismic slip. *Science* 348, 1224 (2015), doi: 10.1126/science.aab0476.
- Itasca Consulting Group (2016), Three Dimensional Distinct Element Code, Version 5.2, Minneapolis, MN, USA.





## GeoProc2017

6th International Conference on Coupled THMC Processes in Geosystems  
5-7 Jul 2017 Paris (France)

### **Non-symmetry of a hydraulic fracture due to the inhomogeneity of the reservoir**

*Alexey N. Baykin<sup>1</sup>, Sergey V. Golovin<sup>2</sup>*

*Keywords: Inhomogeneous reservoir, Non-symmetric fracture, Poroelasticity*

It is usually assumed that a hydraulic fracture has two symmetrical wings with respect to the fluid injection point. Hence, authors limit themselves to modelling of one half of the fracture. In our talk, we demonstrate that the case of a symmetrical fracture occurs only in a homogeneous reservoir with constant physical parameters and confining *in situ* stress. Otherwise, the hydro-mechanical interaction due to inhomogeneity in the stress or the rock permeability can significantly change the dynamics of the fracture.

The mathematical model of the hydraulic fracturing is adopted from (Golovin, Baykin, 2016; Baykin, Golovin, 2016). The model is based on the Biot's poroelasticity equations coupled with the lubrication equation within the fracture. Using this model we demonstrate that in the case of the non-constant confining *in situ* stress the fracture extends non-symmetrically, i.e. the wing in the layer with the higher confining stress stops whereas the wing in the layer with the lower stress extends. The same effect of the fracture non-symmetry can be reached in case of inhomogeneous physical properties of the reservoir due to the formation of the backstress caused by the pressure of pore fluid.

To demonstrate this effect, we perform numerical experiment for fracture propagation in a composite medium such that two neighboring semi-spaces have different permeabilities (see Figure 1). The fracture is originated in the higher-permeable part and propagates towards the lower-permeable region. As one of two fracture's tips approaches the border between the regions, the fracture either breaks into the low-permeable region or penetrates the high-permeable zone depending on the distance between the injection point and the border. The second is demonstrated in Figure 2. The right fracture's tip stops as it almost reaches the border between the two layers, whereas the left tip moves until it reaches the barrier. As the fracture cannot penetrate the barrier, it first widens up and, after some time, breaks into the low-permeable part and propagates to the right layer such that the left wing shuts-in.

This behavior is explained by the hydro-mechanical interaction between the pressure of pore fluid and the elastic response of the rock due to the formation of the so-called backstress. In our talk, we give a formal definition of the backstress and compute its

---

<sup>1</sup> Lavrentyev Institute of Hydrodynamics, Novosibirsk, Russia, [alexey.baykin@gmail.com](mailto:alexey.baykin@gmail.com)

<sup>2</sup> Novosibirsk State University, Novosibirsk, Russia, [golovin@hydro.nsc.ru](mailto:golovin@hydro.nsc.ru)

value for cases with non-monotonic fracture development in order to explain the observed effects of the fracture non-symmetry.

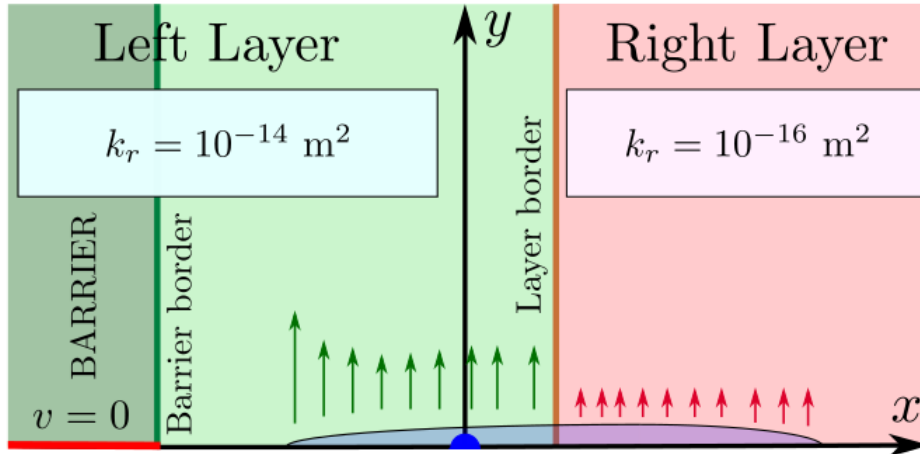

Figure 1: Reservoir with high-permeable (left) and low-permeable (right) layers. The barrier prevents the fracture propagation. Arrows sketch the velocity of the fluid filtration

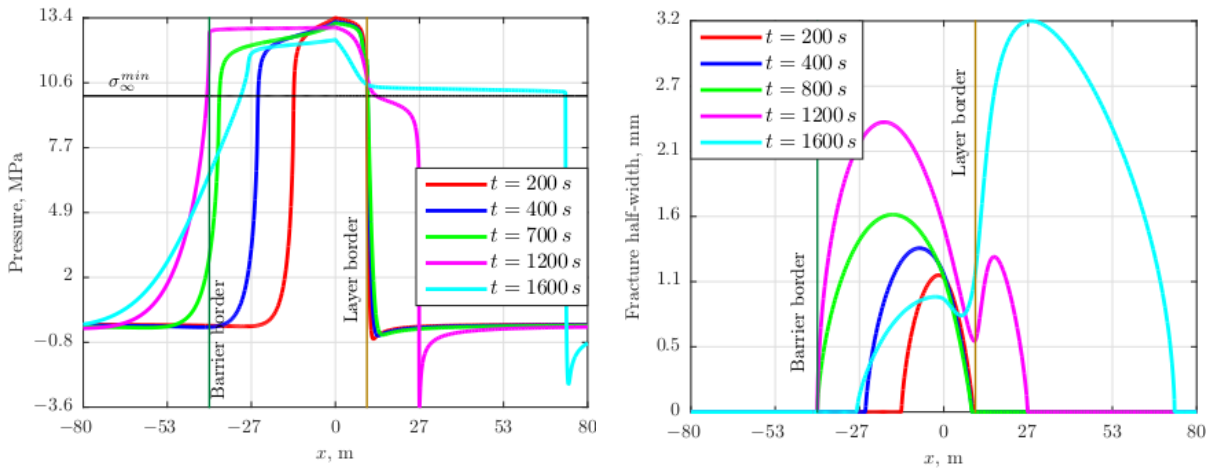

Figure 2 : Pressure (left) and fracture half-width (right) along the fracture at different time for reservoir with two zones with high permeability contrast.

In order to support our conclusions, we perform the same numerical experiments for the case of uncoupled medium where the pore pressure and fluid filtration are not linked with the rock deformation. In this case, the backstress is zero and we obtain almost symmetrical picture of fracture propagation with a small non-symmetry of the two wings explained by the difference of the leakoffs in the two regions.

The non-symmetry of fracture propagation due to the inhomogeneity of confining stresses or the reservoir's physical properties evidences that modelling of fracture propagation within the classical approaches where hydro-mechanical interaction within the reservoir is not taken into account, can lead to significant errors in the estimation of the parameters of hydraulic fractures.

The work is supported by Russian Science Foundation (grant 15-11-20013) and President grant for support of Leading scientific schools (grant SSc-8146.2016.1).

## References

- Golovin S.V., and A.N. Baykin (2016), Influence of pore pressure to the development of a hydraulic fracture in poroelastic medium, <https://arxiv.org/abs/1608.08001>
- Baykin A.N., and S.V. Golovin (2016), Modelling of hydraulic fracture propagation in inhomogeneous poroelastic medium, *J. Phys.: Conf. Ser.*, 722, 012003, doi:10.1088/1742-6596/722/1/012003



## GeoProc2017

6th International Conference on Coupled THMC Processes in Geosystems  
5-7 Jul 2017 Paris (France)

### **Numerical Advances to simulate Shear Failure and Tensile Failure due to Hydraulic Fracturing Operations**

*B. Gómez-Castro<sup>1 3</sup>, S. De Simone<sup>2 3</sup>, J. Carrera<sup>2 3</sup>*

*Keywords: Hydraulic Fracturing, Thermo-Hydro-Mechanical Coupling, Shear failure, Tensile Failure, Numerical Methods*

In recent years, some geological applications like the CO<sub>2</sub> storage or the hydraulic fracturing have attracted the attention not only of the scientific community but also of the general public. One of the reasons of the controversy generated by these topics is the ignorance about some processes that can take place during the realization of this kind of operations. In fact, several questions are still unresolved: how long will the fractures propagate?, Will the contaminated fluid or the released gas leak to aquifers or to the atmosphere? Will the injection process induce seismicity? What magnitude?

Hence, the aim of this work (developed as a part of the EU - FracRisk project) is to answer some of these questions identifying the parameters which are key in the hydraulic fracturing operation. In order to do that, a new thermo-hydro-mechanical Finite Element code has been developed in the *Kratos* framework using C++. As part of this code, a different method to solve the shear and the tensile failure has been proposed. In this method, fractures are represented as a zero thickness element, this means that both sides of the element lie together in the initial configuration (it seems a 1D element in a 2D domain, and a 2D element in a 3D domain) and separate as the adjacent matrix elements deform (Figure 1).

Since the hydraulic fracturing operations take place in hard, fragile rocks, an elastic matrix can be assumed and irreversible displacements in fractures when rock failure occurs can be imposed. The formulation used to simulate shear and tensile failure is based on the analytical solution proposed by Okada (1992) and it is part of an iterative process. Thus, the fracture failure is calculated in a straightforward manner, avoiding numerical issues and capturing the domino effect that may occur when the failure process is triggered in a zone.

---

<sup>1</sup> Department of Civil and Environmental Engineering, Universitat Politecnica de Catalunya (UPC), Jordi Girona 1-3, 08034 Barcelona, Spain

<sup>2</sup> Institute of Environmental Assessment and Water Research (IDAEA), CSIC, Jordi Girona 18-36, 08034 Barcelona, Spain

<sup>3</sup> Associated Unit: Hydrogeology Group

In conclusion, the goal of this work is to analyze the main uncertainties related with the thermo-hydro-mechanical behavior of fractures derived from the hydraulic fracturing operations by means of the new code and method developed.

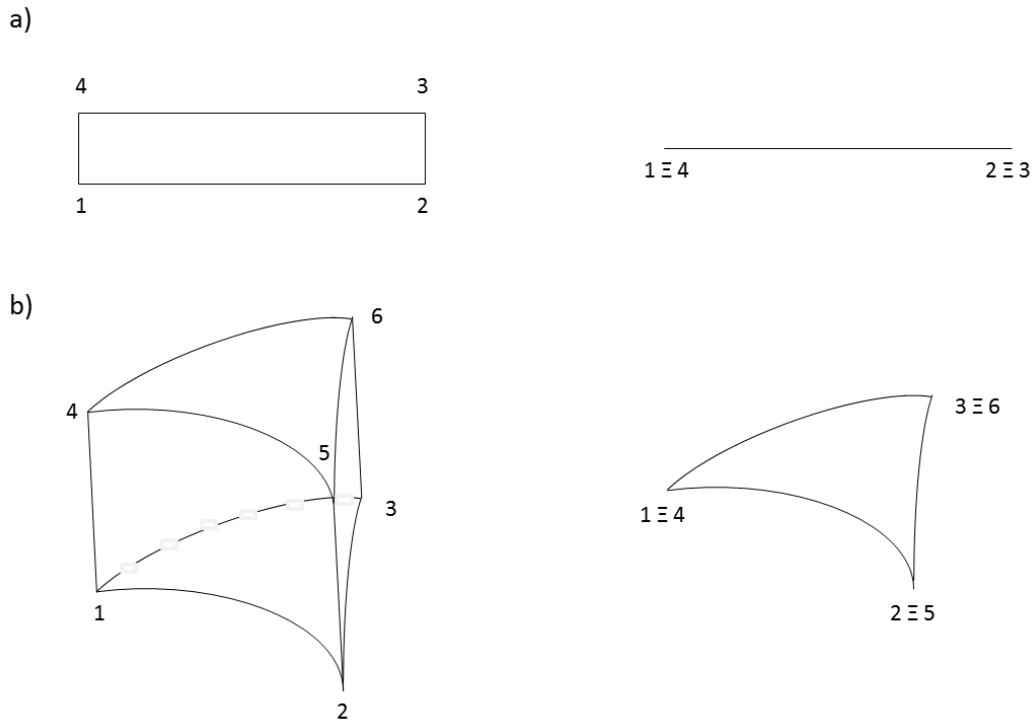

Figure 1. **a)** Interface element in a 2D domain. **Left:** Deformed configuration. **Right:** Initial configuration with zero thickness. **b)** Interface element in a 3D domain. **Left:** Deformed configuration. **Right:** Initial configuration with zero thickness.

## References

Okada, Y. (1992). Internal deformation due to shear and tensile faults in a half-space. Bulletin of the Seismological Society of America, 82(2).



## GeoProc2017

6th International Conference on Coupled THMC Processes in Geosystems  
5-7 Jul 2017 Paris (France)

### **Gas seepage from saturated sediments: Coupling flow and Geomechanics**

*R. Holtzman*<sup>1</sup>, *I. Vaknin*<sup>2</sup>, *O. Katz*<sup>3</sup>, *E. Aharonov*<sup>4</sup>

*Keywords: Fluid-fluid displacement; Mechanical deformation; Analog Experiments*

Natural gas is emitted in large quantities from the ocean floor. Many gas seeps originate from oil and gas reservoirs and from methane hydrate deposits, and thus affect, and serve to indicate, energy resources. Hydrocarbon seepage networks often deform the sediment, producing structures like pockmarks, mud volcanoes, and domes. The coupling between seepage and sediment deformation controls the spatially-and temporally variable seepage dynamics, and understanding it is key to using near-surface geochemical methods for basin assessment and prospect evaluation.

Here, we simulate coupled gas seeps and sediment deformation, to identify the underlying mechanisms for gas escape from oceanic sediments. Experimentally, we inject air into water-saturated sand "reservoir" layer overlain by fine clay "seal". We observe three main seepage mechanisms: (i) diffuse, continuous seepage, without appreciable deformation, for thin "reservoirs" (small gas-column) and thick seals; (ii) gas bubble that migrate upwards in the clay by ductile deformation of the matrix; and (iii) episodic gas-venting through fractures, often preceded by doming (Fig. 1). When the seal is thin and gas-column is tall, doming occurs, doming of the seal layer often precedes gas release by mechanism (ii) and (iii). Our experiments suggest that these mechanisms depend on the interplay between gas-buoyancy force (controlled by gas-column height, constrained by "reservoir" thickness), confining stress (here lithostatic, i.e. seal layer thickness) and sediment mechanical properties. Our findings improve our understanding of gas-seepage mechanisms, rates, timing and locations.

---

<sup>1</sup> The Hebrew University of Jerusalem, holtzman.ran@mail.huji.ac.il

<sup>2</sup> The Hebrew University of Jerusalem, inbar.vaknin@mail.huji.ac.il

<sup>3</sup> Geological Survey of Israel, odedk@gsi.gov.il

<sup>4</sup> The Hebrew University of Jerusalem, einatah@mail.huji.ac.il

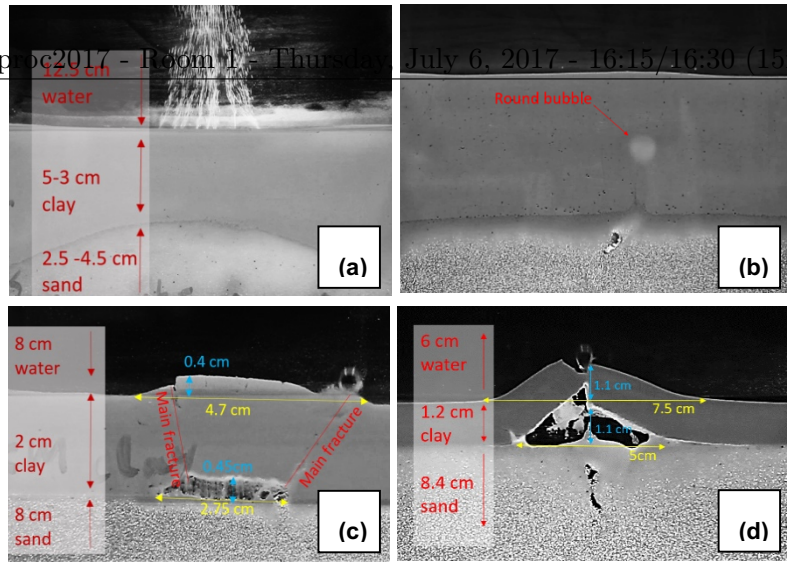

Figure 1: Experimental realization of the three main seepage modes at different layer thickness and clay types: (i) diffusive seepage in limestone clay, when clay layer is relatively thick (panel a); (ii) seepage by plastic deformation in kaolinite (b); (iii) doming, fracturing and seepage along fractures when clay layer is relatively thin in (c) limestone clay and (d) kaolinite.



## GeoProc2017

6th International Conference on Coupled THMC Processes in Geosystems  
5-7 Jul 2017 Paris (France)

### On Poroelastic State Initialization under the Influence of Gravity

*E. Holzbecher<sup>1</sup>*

*Keywords: Poroelastics, Steady State, Layered System*

The Biot poroelastical approach is commonly used for the hydraulic-mechanical coupling in THMC models. In application cases it is often required to start with an initial solution that represents no-flow hydrostatic conditions, before the transient response of the geological system to an altered stress or pressure regime can be simulated.

If gravity is to be considered in both the hydraulic and geomechanical approaches the hydrostatic no-flow state solution is not compatible with the zero displacement solution. Modelers mostly circumvent this problem by introducing a pre-stress time period, in which the numerical simulation is assumed to converge to the undisturbed steady state.

The described procedure requires additional work that is not directly related to the problem. Several test runs may be necessary in order to find the appropriate length of the time-period to reach the steady state. In this contribution a more elegant procedure is demonstrated.

For the undisturbed steady state under hydrostatic conditions an analytical solution is derived, for a single layer as well as for multi-layer systems (Holzbecher 2016). For typical problems of changed stress/pressure, loading as well as pumping or injection, it is convenient to utilize the solution as initial condition. Moreover the analytical formulae are useful as a reference for transient and stationary states under a changed regime.

The procedure is demonstrated for an application case, introduced by Nopper et al. (2012), where water is injected into a three-layer geological system. The intermediate injection layer is characterized by a higher permeability and a lower E-modul. The entire depth is 3000 m. The system is considered in cylindrical and planar coordinate systems.

For numerical modeling the COMSOL Multiphysics code (2016) is used. The software calculates numerical solutions for coupled systems of partial differential equations using the method of finite elements. The versatile graphical user interface allows easy coupling of various physics modes. Moreover there are multiple options for the finite elements, for meshing and solution procedures, not to speak of output visualization. Thus COMSOL Multiphysics is very convenient for solving THMC problems.

---

<sup>1</sup> German University of Technology in Oman (GUtech), P.O.Box 1816, 130 Muscat, Oman, [ekkehard.holzbecher@gutech.edu.om](mailto:ekkehard.holzbecher@gutech.edu.om)

For the demonstration case Figure 1 shows the development of deformations along the borehole in the cylindrical coordinate system. The lower layer (0-1000m) shrinks up to approximately 0.5m, while the upper layer (above 1500m) is shifted 3.5 m upward, at maximum, before the injections stops after 7 days (legend number in days). After that the deformations decrease.

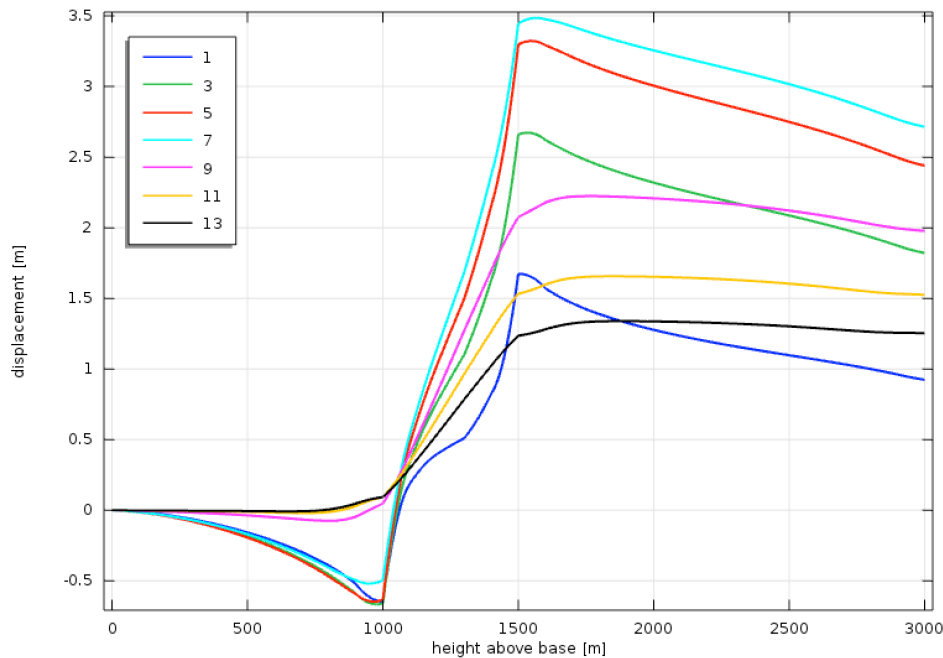

Figure 1. Transient deformation due to injection, legend denotes days after injection start; see text for details

In a study on energy piles Holzbecher (2014) presented another application case, in which the thermal regime was considered in addition to the hydraulic-mechanical coupling (THM). Major findings from that study will be presented also.

## References

- COMSOL Multiphysics (2016), <http://www.comsol.com>
- Holzbecher E. (2014), Energy Pile Simulation – an Application of THM-Modeling, *COMSOL Conf. 2014*, Cambridge, UK
- Holzbecher E. (2016), Poroelastical Regimes under the Influence of Gravity, submitted
- Nopper R.W., Clark J.E., Miller C. (2012) Poroelastic models of stress diffusion and fault re-activation in underground injection, *COMSOL Conf. 2012*, Boston, USA



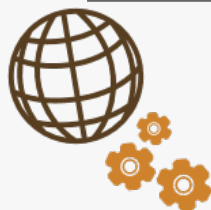

## GeoProc2017

6th International Conference on Coupled THMC Processes in Geosystems  
5-7 Jul 2017 Paris (France)

### THMC in deep geological nuclear waste disposal

*Manman Hu<sup>1</sup>, Manolis Veveakis<sup>2</sup>, Klaus Regenauer-Lieb<sup>3</sup>*

*Keywords: THMC coupling, shear instability, nuclear waste management, geological disposal.*

In the context of managing geological disposal of radioactive nuclear waste, safety is of the priority concern. From the regulatory perspective, investigations on the coupled Thermo-Hydro-Mechanical-Chemical (THMC) processes occurring in the host environment at various stages of the disposal implementation are essential. For clayey host rocks, the main THMC related issues that might trigger instability in the isolation system include thermal softening of the host formations by residual heat of the nuclear waste, the swelling of clay minerals, clay dehydration, thermally activated water-releasing chemical reactions, thermal pressurization of the fluid, as well as potential microbiological processes (Bernier et al., 2017).

Among currently available options of isolation method, deep geological disposal has been considered as the most promising method, endorsed by the Blue Ribbon Commission on US's Nuclear Future (2012). An essential challenge for implementation of deep geological disposal is to understand the coupled THMC processes within an even more complicated scenario: the high pressure high temperature conditions. The goal is to prevent re-activation of pre-existing cracks or generation of new cracks in the surrounding rock formation, which could lead to the leakage of radioactivity and contaminated fluids. Nuclear waste in the containers heats up the repository host rock, creating a so-called melt zone around the borehole. Ductile processes are thermally activated in the melt zone, triggering chemical dissolution/ precipitation, feeding back on pore pressure change as well as material degradation. This study investigates potential shear banding in a high temperature borehole scenario from a material bifurcation point of view. Each involved physical process can provoke instability in the system of governing equations, which eventually induces localized permeability channels at different scales.

Our preliminary simulation results have shown localization pattern of normalized temperature as logarithmic spirals around a heated borehole (Fig.1 a) and the respective pore pressure profile (Fig.1 b) within a Thermo-Hydro-Mechanical

<sup>1</sup> School of Petroleum Engineering, UNSW Sydney, manman.hu@unsw.edu.au

<sup>2</sup> School of Petroleum Engineering, UNSW Sydney and CSIRO Australia, e.veveakis@unsw.edu.au

<sup>3</sup> School of Petroleum Engineering, UNSW Sydney, klaus@unsw.edu.au

framework. Various factors affecting shear localization are studied, including rock type, borehole wall temperature, and thermal diffusivity of the surrounding rock. The future work will include implementing the chemical effect into this framework and studying its feedback mechanisms between other physical processes and eventually forming a full THMC model.

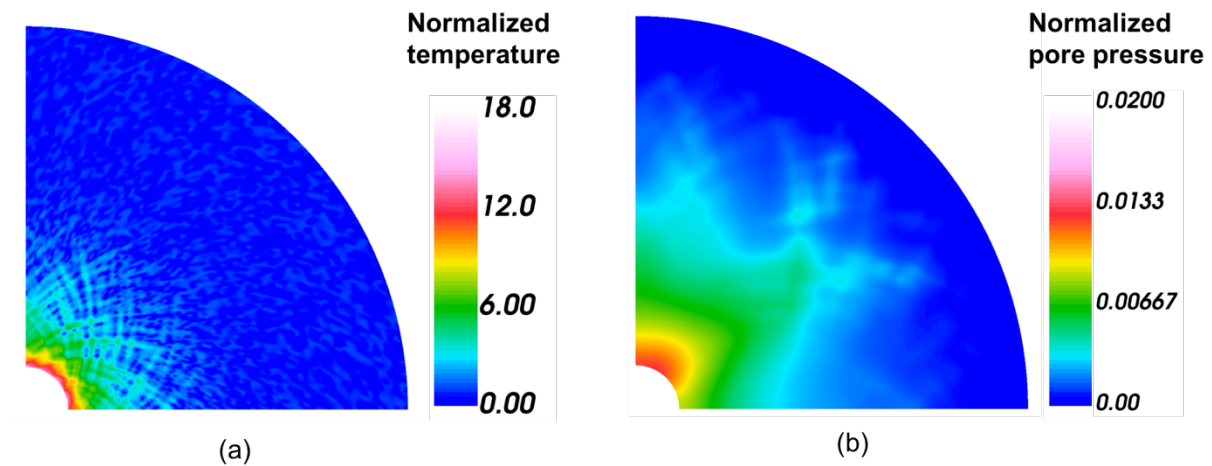

Figure 1. a) Shear bands (indicated by temperature localization) self-organize into logarithmic spirals with random temperature perturbation; b) Profile of normalized pore pressure.

## References

- Bernier, F., Lemy, F., De Cannière, P., & Detilleux, V. (2017), Implications of safety requirements for the treatment of THMC processes in geological disposal systems for radioactive waste, *Journal of Rock Mechanics and Geotechnical Engineering*. doi: 10.1016/j.jrmge.2017.04.001.
- Report to the Secretary of Energy (2012), Blue Ribbon Commission on America's Nuclear Future: Executive Summary, January 2012.



## GeoProc2017

6th International Conference on Coupled THMC Processes in Geosystems  
5-7 Jul 2017 Paris (France)

### **Model development for fully coupled hydro-thermal-mechanical analysis of brine migration in salt**

*M. Hu<sup>1</sup>, J. Rutqvist<sup>2</sup>*

*Keywords: Full hydro-thermal-mechanical coupling, nuclear waste disposal, salt formation, brine migration, dual-continuum model*

The disposal of heat-generating nuclear waste in a salt repository results in a thermal gradient around the waste package that may lead to migration brine inclusions towards the heat source. The inclusions can migrate up the thermal gradient by salt dissolution at the hot face of the inclusion and crystallizing at the cold face. Brine migration towards the waste package may lead to increased corrosion of the waste package and can also impact the mechanical evolution of crushed salt backfill around the waste package. Therefore, it is important to analyze the migration of brine inclusions under thermal gradients to properly evaluate the performance of nuclear wastes storage in salt host formations. To study and analyze such a phenomenon, in this study a coupled hydro-thermal-mechanical (THM) model based on the finite volume method (FVM) was developed. Fluid flow in terms of advective and diffusive fluxes in the interconnected pore space, and diffusive and thermal-diffusive fluxes in the salt grains is thoroughly considered. Due to very distinct behavior of fluid flow in the interconnected pore space and in the salt grains, this process is simulated based on a dual-continuum model (Figure 1). In the dual-continuum model, mass balance of salt and water in these two continuum is separately considered, and their coupling is represented by flux associated with brine migration. Meanwhile, energy balance in the whole system is uniformly simulated. The mechanical equilibrium is established on the assumption of equivalent continuous media. Based on finite-element concept, the approximation for mechanical analysis is shared with the centers of the rectangular finite volume cells. The coupling between thermal and mechanical fields is only considered in terms of thermal expansion. And the coupling between the hydraulic and mechanical fields are in terms of pore-volume effects governed by Biot's equations. Therefore, a fully coupled THM model is developed. Such a formula constitutes a coupled THM model with strong nonlinear feature, involving salt concentration effect on fluid mass associated with advection, and involving thermal effect on brine migration. Newton-Raphson iteration formula is used to generate the linearized equations for this nonlinear problem. The model was verified by pore-scale and large-scale brine inclusion migration for TH coupling, and by consolidation problems for HM coupling. Then it was verified against an independent numerical model (TOUGH2-

<sup>1</sup> Lawrence Berkeley National Laboratory, [mengsuhu@lbl.gov](mailto:mengsuhu@lbl.gov)

<sup>2</sup> Lawrence Berkeley National Laboratory, [jrutqvist@lbl.gov](mailto:jrutqvist@lbl.gov)

FLAC3D) for THM modeling. Lastly, it was applied for large-scale, long-term analysis of heat-generating nuclear waste disposal in salt formation.

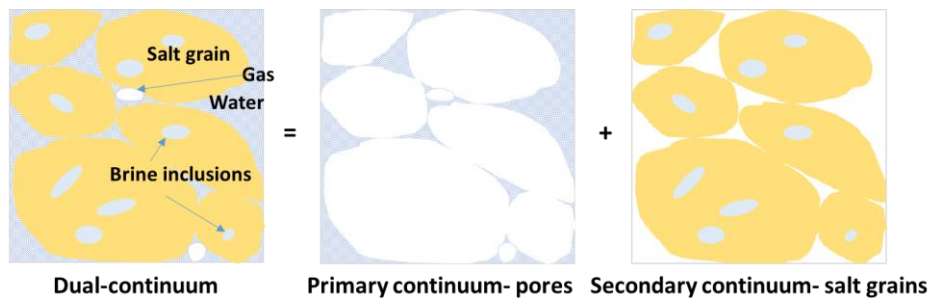

Components	In primary continuum	In secondary continuum
<b>Salt</b>	Salt (solid or dissolved)	Salt (solid or dissolved)
<b>Water</b>	Water (liquid and gas)	Water (liquid)

Figure 1. Schematic of the dual-continuum model for salt migration.



## GeoProc2017

6th International Conference on Coupled THMC Processes in Geosystems  
5-7 Jul 2017 Paris (France)

### **Long- and short-term evolution of engineering properties of geomaterials: drying of capillary water**

*T.Hueckel*<sup>1</sup>, *B. Mielniczuk*<sup>2</sup>, *M.S. El Youssoufi*<sup>3</sup>

*Keywords: drying, capillary bonds, intergranular forces*

Long term and short term multi-physical processes in geo-materials often critically affect mechanical stability and resilience of earthen structures. These processes may be intentional and often engineered, and in such cases taken into design considerations, but frequently they are unintentional, or right away poorly recognized or overlooked. Many geotechnical and structural failures are believed to originate from a misguided understanding of their failure mode and/or their long-term performance assessment. The best example is a Terzaghi (1950) landslide analysis showing, that the causes are persistent chemical reactions of rock weathering which “weakens intergranular bonds” leading to decrease in cohesion, rather than mere pore pressure increase.

Another example of processes that develop over long time scale, but evolve into a critical state through short term instabilities at different length scales are drying and drying-cracking. Drying of soils contributes to (often critical) degradation of earth structures such as levees, dykes, earth dams, clay liners, clay buffers and backfills in nuclear waste disposal. Drying and cracking of soils follows an involved scenario, which consists of several phases: (i) shrinkage of the solid upon evaporation induced suction, or total tensile stress build up, if the soil is constrained against displacement. Effective stress in the presence of high suction and low total tensile stress results to be compressive; (ii) air entry when the water-air interface undergoes instability; (iii) total tensile stress concentration at the tip of the air entry finger; (iv) development of a tensile crack, since due to stress magnification the latter becomes larger than suction, and the effective stress becomes tensile. Peron et al. 2009 observed via mercury porosimetry that first to dry are the larger pores, which consistently become smaller contributing to the macroscopic shrinkage of soil. The larger pores closure and practically soil shrinkage ceases simultaneously with the air entry. However, the smaller pores continue to evaporate, but their contribution to shrinkage is minor. Modeling of the above phenomena requires considerations at several scales. Hu et al. 2013 simulated evaporation from a porous system seen as a bunch of parallel deformable tubes of two sizes, including a moment of air entry.

<sup>1</sup> Duke University, Durham, NC, USA, hueckel@duke.edu,

<sup>2</sup> University of Montpellier, France, boleslaw.mielniczuk@umontpellier.fr

<sup>3</sup> University of Montpellier, France, moulay-said.el-youssoufi@umontpellier.fr

Air entry occurs at a point when a decreasing meniscus radius becomes smaller than the largest pore throat radius, the latter depending on deformability of the vessels, reaching a critical pressure difference between fluid,  $p$ , and atmosphere,  $p_a$ . It was observed that air entry occurs within 1/1000 of a second producing a well-articulated singularity of the external surface of the porous medium, Fig. 1. We postulate that at the tip of that singularity, a feeble total tensile stress induced by a constrained shrinkage becomes amplified by an order of magnitude, what changes the compressive effective stress to tensile while its value easily becomes larger than tensile strength. Using the principles of linear fracture mechanics, the stress at the external boundary of the tubes, which are placed near the flaw tip. Once a crack is generated at a most stressed air entry point, it propagates further at a modest speed controlled by the rate of continuous evaporation (for details see Hueckel et al. 2015). The critical time to cracking depends on the water advection to the interface with the atmosphere and solid compressibility that define suction required to trigger the air entry.

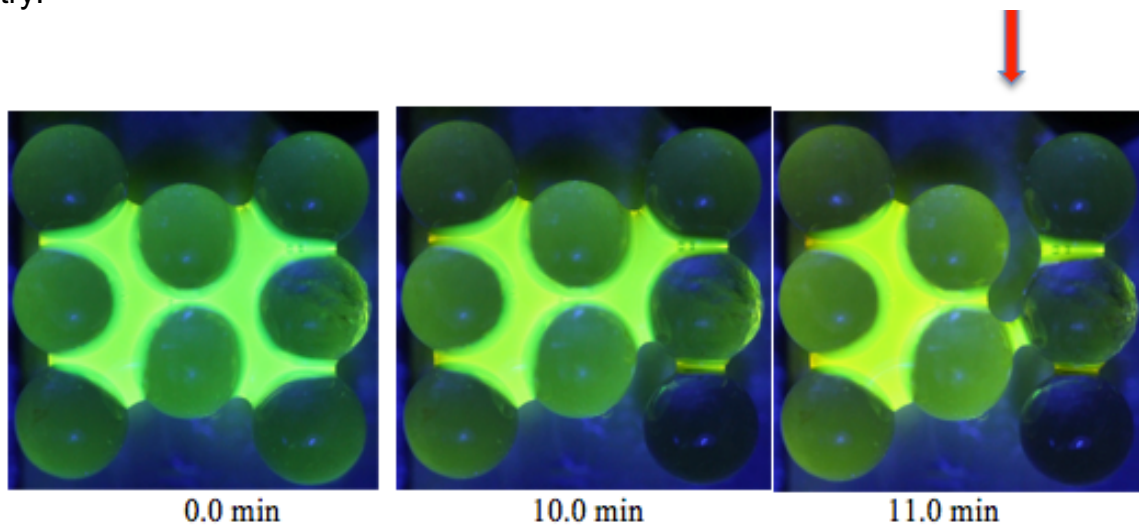

Figure 1. Air entry into a drying body of capillary water in a form of a boundary instability forming a flaw and a stress concentration

The air entry has been seen taking on two different forms depending on local Gaussian curvature of the water body. The value of the initial air entry pressure seems to follow the classical Laplace law. It was also found that intergranular attractive forces grow insignificantly during drying before declining to zero or jump to zero at rupture. Suction in drying capillary bridges never reaches high values reported in macroscopic studies, and often evolves into positive pressure prior to rupture. In final phases of evaporation high gradient of pressure and visible internal flow are seen.

## References

- Hu, L.B., Peron, H., Hueckel, T., Laloui, L. (2013) Desiccation shrinkage of non-clayey soils: multi-physics mechanisms and a microstructural model. *J. N. Anal. Meth. Geomech.* 37(12), 1761–81.
- Hueckel, T., Mielniczuk, B., El Youssoufi, M.S., Hu, L.B., Laloui, L. (2014): A three-scale cracking criterion for drying soils. *Acta Geophys.* 62(5), 1049–1059.
- Peron, H., Hueckel, T., Laloui, L., Hu, L.B. (2009), Fundamentals of desiccation cracking of finegrained soils: experimental characterisation and mechanisms identification. *Can. Geot. J.* 46, 1177–1201.
- Terzaghi, K. Mechanism of Landslides (1950). *Cambridge: Harvard University, Depart. of Eng.*



## GeoProc2017

6th International Conference on Coupled THMC Processes in Geosystems  
5-7 Jul 2017 Paris (France)

### **From localized to homogeneous deformation of porous rocks – insights from laboratory experiments and numerical modelling**

*A. B. Jacquey<sup>1</sup>, M. Cacace<sup>2</sup>, G. Blöcher<sup>3</sup>, H. Milsch<sup>4</sup> and F. Deon<sup>5</sup>*

*Keywords: Strain localization, Hydro-mechanical, Laboratory, Numerical modelling*

Hydraulic stimulation of geothermal wells is often used to increase heat extraction from deep geothermal reservoirs. Initiation and propagation of fractures due to pore pressure build-up increase the effective permeability of the porous medium. Understanding the processes controlling the initiation of fractures, the evolution of their geometries and the hydro-mechanical impact on transport properties of the porous medium is therefore crucial for enhanced geothermal energy production. In this study, we present an approach including laboratory results of tri-axial experiments on sandstones, micro-structure analysis and numerical modeling aiming at better understanding and identifying the processes controlling micro-cracking and strain localization.

#### **Laboratory experiments**

Three tri-axial experiments under drained conditions were conducted at room temperature on cylindrical sandstone samples (Bentheimer sandstone) under different confining pressures (40, 70 and 100 MPa). In addition, continuous porosity measurements were conducted during these experiments. It can be observed from these experiments that the deformation behaviour ranges from homogeneous compaction to localized features and therefore depends on the confining pressure (see Figure 1). The first experiment under low confinement led to a clear shear failure. The second one with high confinement showed more homogeneous deformation with initiation of shear-induced compaction bands. The last one with an intermediate confinement showed a transitional regime between the two first experiments. The evolution of the porosity is tightly coupled with the deformation behaviour.

To better identify the physical processes controlling the different deformation behaviours, micro-structure analysis has been conducted including X-ray Powder Diffraction (XRD), Electron Microprobe (EMP) and three-dimensional CT scanning. These analyses showed evidences of micro-cracking processes and help quantifying

---

1 GFZ – German Research Centre for Geosciences, antoine.jacquey@gfz-potsdam.de

2 GFZ – German Research Centre for Geosciences, cacace@gfz-potsdam.de

3 GFZ – German Research Centre for Geosciences, bloech@gfz-potsdam.de

4 GFZ – German Research Centre for Geosciences, milsch@gfz-potsdam.de

5 Delft University of Technology, f.deon@tudelft.nl

distribution and extend of a damage domain around the localized fracture planes. Evidences of pore collapse were also identified.

## Modelling strategy and implementation

A model for deformation of porous rocks dealing with the physical processes mentioned above will be presented. It makes use of a poro-elastoplastic model including hardening and softening of the elastic stiffness of the porous rock in order to represent micro and macro cracking processes. To avoid mesh-dependency of the results obtained by the elastoplastic constitutive laws with softening, we introduce a viscous correction term (Maxwell viscoelasticity) as a regularization technique. This approach can be considered as an alternative to the viscoplastic constitutive laws of Perzyna [Perzyna 1971]. Hydro-mechanical coupling is also considered by introducing appropriate porosity and permeability dependencies.

The model presented here as been implemented in a multiphysics finite-element-method based numerical simulator called GOLEM, based on the MOOSE (Multiphysics Object-Oriented Simulation Environment) framework [Gaston et al. 2009]. Calibration of the model will be presented by means of the experimental results introduced previously.

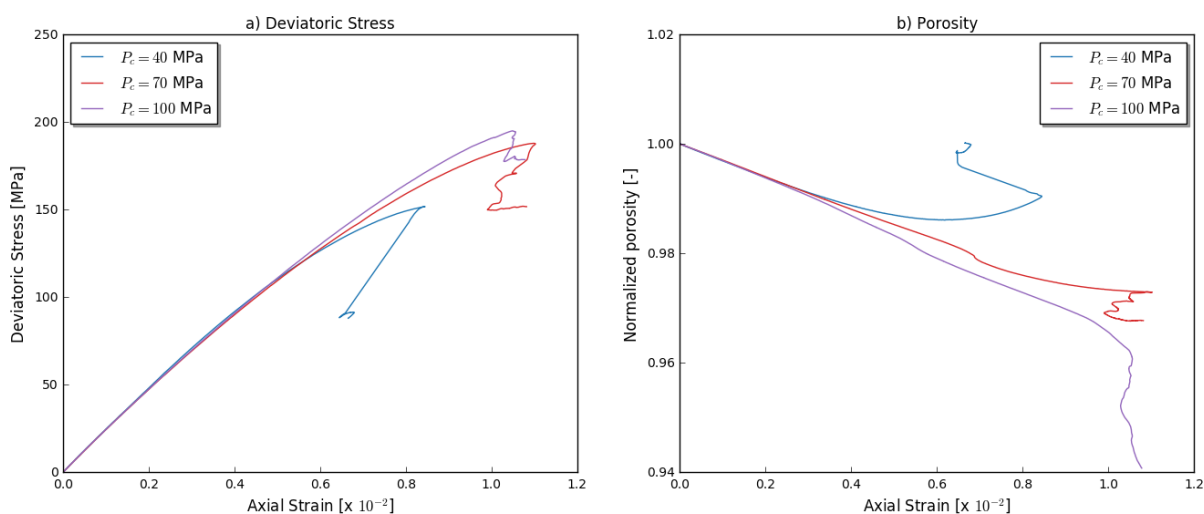

Figure 1: Results from laboratory drained tri-axial experiments with different confinements. a) shows the deviatoric stress and b) the porosity as functions of the axial strain.

## References

- Gaston, D., C. Newman, G. Hansen, and D. Lebrun-Grandie (2009), MOOSE: A parallel computational framework for coupled systems of nonlinear equations, *Nucl. Engrg. Design*, 239, 1768-1778, doi:10.1016/j.nucengdes.2009.05.021
- Perzyna, P. (1971), Thermodynamic Theory of Viscoplasticity, *World Journal of Mechanics*, 11, 313-354.





## GeoProc2017

6th International Conference on Coupled THMC Processes in Geosystems  
5-7 Jul 2017 Paris (France)

### **Modeling stress transfer during hydraulic stimulation of geothermal reservoirs**

*G. Jansen<sup>1</sup>, S.A. Miller<sup>2</sup>*

*Keywords: EGS, stress transfer, discrete fracture, induced seismicity*

A large fraction of the world's water and energy resources are located in naturally fractured reservoirs within the earth's crust. Depending on the lithology and tectonic history of a formation, fracture networks can range from dense and homogeneous highly fractured networks to single large scale fractures dominating the flow behaviour. Understanding the dynamics of such reservoirs in terms of flow and transport is crucial to successful application of engineered geothermal systems (also known as enhanced geothermal systems or EGS) for geothermal energy production in the future.

Fractured reservoirs are considered to consist of two distinct separate media, namely the fracture and matrix space respectively. Fractures are generally thin, highly conductive containing only small amounts of fluid, whereas the matrix rock provides high fluid storage but typically has much smaller permeability.

Simulation of flow and transport through fractured porous media is challenging due to the high permeability contrast between the fractures and the surrounding rock matrix. However, accurate and efficient simulation of flow through a fracture network is crucial in order to understand, optimize and engineer reservoirs. It has been a research topic for several decades and is still under active research. Accurate fluid flow simulations through field-scale fractured reservoirs are still limited by the power of current computer processing units (CPU).

We present an efficient implementation of the embedded discrete fracture model, which is a promising new technique in modeling the behavior of enhanced geothermal systems. An efficient coupling strategy is determined for numerical performance of the model. We provide new insight into the coupled modeling of fluid flow, heat transport of engineered geothermal reservoirs with focus on the stress changes during the stimulation process. We account for thermo- and poro-elastic stress changes as well as slip induced stress changes in the model to provide better estimations to the onset of fracture slip. Slip-induced stress changes are modeled based on Okada's analytical formulas derived from a Green's function solution to the elastic half space problem (Okada, 1992). The type of deformation largely controls the pattern of the induced stress change (cf. Figure 1). Thus all deformation modes are included in our model. Combined with a statistic displacement estimation, the stress changes induced during

---

1 CHYN - Centre for Hydrogeology and Geothermics, Laboratory of Geothermics and Geodynamics, University of Neuchâtel, Rue Emile-Argand 11, CH-2000 Neuchâtel (gunnar.jansen@unine.ch)

2 CHYN - Centre for Hydrogeology and Geothermics, Laboratory of Geothermics and Geodynamics, University of Neuchâtel, Rue Emile-Argand 11, CH-2000 Neuchâtel (stephen.miller@unine.ch)

the injection period of reservoir development can be studied. A detailed evaluation of the individual components of stress transfer as well as their combination will conclude our presented work.

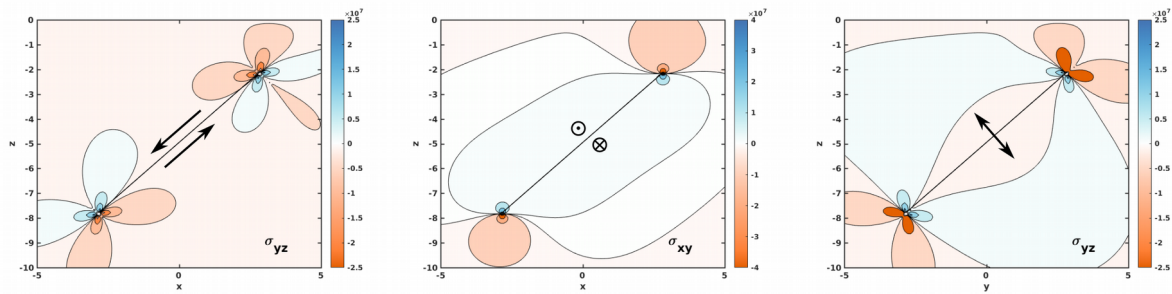

*Seismological Society of America*, 82(2), 1018-1040.



## GeoProc2017

6th International Conference on Coupled THMC Processes in Geosystems  
5-7 Jul 2017 Paris (France)

### Finite Strain description of Fractal Damage in Geo-materials

A. Karrech<sup>1</sup>, H. Basarir<sup>2</sup>, F. Abbassi<sup>3</sup>, A. Seibi<sup>4</sup>, M. Elchalakani<sup>5</sup>

*Keywords: Finite strain, Up-scaling, Self-Similar Damage, Finite Element Method*

In this communication, we present an up-scaling approach that describes the overall non-linear behavior of geo-materials embedding local defects both in the reversible and irreversible thermodynamic regimes. We introduce a self-consistent scheme (Mori, T. and Tanaka, K. (1973)) that takes into account the fractal distributions of such defects.

Based on Diamond Anvill Cell experimental data obtained for a wide range of minerals, we verify that the logarithmic (Hencky) strain produces the closest agreement with experiment compared to common Seth-Hill measures of deformation (Karrech et al. (2011)). In addition, we extend the Eshelby-Hill based self-consistent up-scaling of heterogeneous media to the context of logarithmic finite strain (Nemat-Nasser, S. (1999) Eshelby, J. D. (1957)). Consequently, we develop a damage mechanics method that investigates the effects of self-similar (fractal) distribution of defects and their propagation. The whole framework is implemented numerically using the finite element method with a particular emphasis on material and geometrical nonlinearities that are both represented in the proposed integration algorithm.

To verify the applicability of the model, we introduce particular examples where solid blocks are subjected to partial/full confinement conditions under force/displacement controlled loading. We solve the problems analytically and numerically and show that the proposed methodologies produce acceptable agreements.

#### References

- Eshelby, J. D. (1957). The determination of the elastic field of an ellipsoidal inclusion, and related problems. *Proceedings of the Royal Society of London A: Mathematical, Physical and Engineering Sciences*, 241(1226):376–396.
- Mori, T. and Tanaka, K. (1973). Average stress in the matrix and average elastic energy of materials with misfitting inclusions. *Acta Materialia*, 21:571–574.
- Nemat-Nasser, S. (1999). Averaging theorems in finite deformation plasticity. *Mechanics of Materials*, 31(8):493 – 523.
- Karrech, A., Regenauer-Lieb, K., and Poulet, T. (2011b). Frame indifferent elastoplasticity of frictional materials at finite strain. *International Journal of Solids and Structures*, 48(3–4):397 – 407

<sup>1</sup>ali.karrech@uwa.edu.au

<sup>2</sup>hakan.basarir@uwa.edu.au

<sup>3</sup>Fethi@du.edu.om

<sup>4</sup>acs9955@louisiana.edu

<sup>5</sup>Mohamed.elchalakani@uwa.edu.au



# GeoProc2017

6th International Conference on Coupled THMC Processes in Geosystems  
5-7 Jul 2017 Paris (France)



geoproc2017 - Room 1 - Wednesday, July 5, 2017 - 17:45/18:00 (15min)



## GeoProc2017

6th International Conference on Coupled THMC Processes in Geosystems  
5-7 Jul 2017 Paris (France)

### Hydraulic apertures of open and sealing fractures

T. Kling<sup>1</sup>, J.-O. Schwarz<sup>2</sup>, F. Wendler<sup>3</sup>, F. Enzmann<sup>4</sup>, P. Blum<sup>5</sup>

*Keywords: Fracture flow, sealing, phase-field model, Navier-Stokes simulation*

Permeabilities of rock fractures in reservoir simulations often are defined by the global hydraulic (or effective) fracture aperture ( $a_h$ ) and the common cubic law [e.g. Blum et al.; 2009]. Typically, hydraulic apertures cannot be directly reproduced from fracture geometries, however rather result from various fracture properties such as mechanical apertures and intrinsic roughness features forming tortuous flow channels. Hence, various corrections have been formulated to estimate hydraulic apertures [e.g. Zimmerman & Bodvarsson, 1996]. These formulas most widely rely on observations made for open (chemically unaffected) fractures. Concerning partially sealed fractures, where mineral precipitation can cause mineral-specific unique sealing and roughness patterns, estimating hydraulic apertures appears to be more challenging.

The objective of this study is therefore to examine how growth patterns of two different crystal habits affect fracture flow with progressive sealing. Since this study focus on the effect of the fracture geometry on fluid flow and not vice versa, growth and flow simulations are sequentially performed. Growth patterns are obtained for needle and compact quartz growth in a parallel plate fracture, by applying the phase-field model (PFM) by Wendler et al. [2015], which was validated for polycrystalline quartz growth in hydrothermal experiments. Based on the 3D volume data resulting from this PFM, fluid flow simulations are performed using the GeoDict software package solving the Navier-Stokes-equation for laminar flow conditions (cf. Figure 1). Both, PFM and flow simulations provide information on geometry-related hydraulics of the fractures at the single stages of progressive sealing.

Simulation results indicate two different growth, and thus flow patterns related to the crystal habits. In particular at lower sealing stages such as 20% sealing, the growth of needle crystals reduces initial fracture permeability by up to ~80%, while the compact quartz fracture still disposes about 40%. This gap relies on the early formation of bridge structures resulting in highly tortuous flow paths resembling a porous media, while compact quartz forms continuous crystal fronts growing against each other. The porous characteristics of the needle quartz patterns also become obvious when applying the Carman-Kozeny equation for porous media, which fits well for the simulation results of

<sup>1</sup> Institute of Applied Geosciences, Karlsruhe Institute of Technology, [tobias.kling@kit.edu](mailto:tobias.kling@kit.edu)

<sup>2</sup> Math2Market GmbH, Kaiserslautern/Germany, [jens-oliver.schwarz@math2market.de](mailto:jens-oliver.schwarz@math2market.de)

<sup>3</sup> Institute of Microstructure Technology, Karlsruhe Institute of Technology, [frank.wendler@kit.edu](mailto:frank.wendler@kit.edu)

<sup>4</sup> Institute of Geosciences, Johannes Gutenberg University Mainz, [enzmann@uni-mainz.de](mailto:enzmann@uni-mainz.de)

<sup>5</sup> Institute of Applied Geosciences, Karlsruhe Institute of Technology, [philipp.blum@kit.edu](mailto:philipp.blum@kit.edu)

needle quartz growth. In contrast, the analytical cubic law fits well for both sealing fractures. Hence, a semi-theoretical equation based on the relative roughness and a geometry factor  $\alpha$  is introduced to link between the (mean) geometrical aperture and  $a_h$  for needle ( $\alpha = 2.5$ ) and compact ( $\alpha = 1.0$ ) quartz growth. Since growth fronts of compact quartz crystals resemble the rough surfaces of chemically unaffected fractures the new equation can also be tested for open fractures.

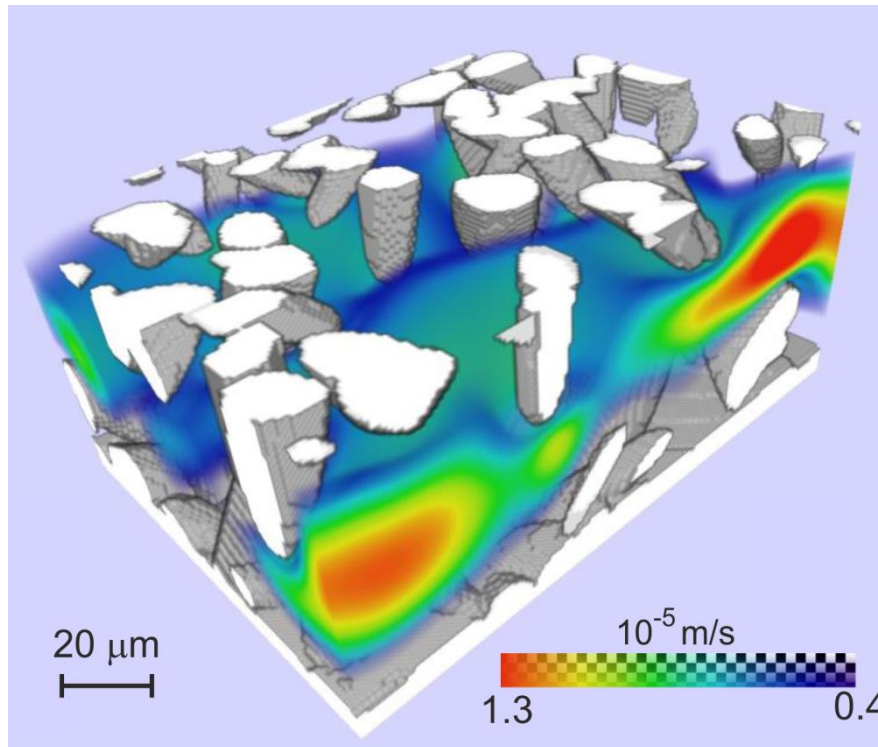

Figure 1. Simulated 3D fluid velocity field in a fracture sealed by needle quartz at an intermediate stage of sealing [Kling et al., 2016].

## References

- Blum, P., Mackay, R., and M.S. Riley (2009), Stochastic simulations of regional scale advective transport in fractured rock masses using block upscaled hydraulic property data, *J. Hydrol.*, 369(3-4), 318-325, doi: 10.1016/j.jhydrol.2009.02.009.
- Kling, T., Schwarz, J.O., Wendler, F., Enzmann, F., and Blum P. (2016), Quartz-driven fracture healing and its impact on fluid flow, paper presented at European Geothermal Congress 2016, European Geothermal Energy Council (EGEC), Strasbourg, France.
- Wendler, F., Okamoto, A., and P. Blum (2015), Phase-field modeling of epitaxial growth of polycrystalline quartz veins in hydrothermal experiments, *Geofluids*, 16(2), 211-230, doi: 10.1111/gfl.12144.
- Zimmerman, R.W., and G.S. Bodvarsson (1996), Hydraulic conductivity of rock fractures, *Transp. Porous Media*, 23(1), 1-30, doi: 10.1007/bf00145263.



## GeoProc2017

6th International Conference on Coupled THMC Processes in Geosystems  
5-7 Jul 2017 Paris (France)

### Computational upscaling of Drucker-Prager plasticity from micro-CT images of synthetic porous rock

Jie Liu<sup>1</sup>, Joel Sarout<sup>2</sup>, Minchao Zhang<sup>3</sup>, Jeremie Dautriat<sup>4</sup>, Emmanouil Veveakis<sup>5</sup>,  
Klaus Regenauer-Lieb<sup>6</sup>

*Keywords: porous rock, micro-tomographic data, Drucker-Prager plasticity, finite element computations*

Quantifying rock physical properties is essential for the mining and petroleum industry. Micro-tomography provides a new way to quantify the relationship between the microstructure and the mechanical and transport properties of a rock. Transport and elastic properties have been studied widely, whereas yield and failure properties are still poorly understood. In this study, we simulate the macro-scale plastic properties of a synthetic sandstone sample made of calcite-cemented quartz grains using the micro-scale information obtained from micro-tomography.

The computations rely on the concept of representative volume elements (RVEs). The mechanical RVE is determined using the upper and lower bounds of finite-element computations for elasticity. We present computational upscaling methods from microphysical processes to extract the plasticity parameters of the RVE and compared results to experimental data. The yield stress, cohesion and internal friction angle of the matrix (solid part) of the rock were obtained with reasonable accuracy (see Fig. 1).

Computations of plasticity of a series of models of different volume-sizes showed almost overlapping stress-strain curves, suggesting that the mechanical RVE determined by elastic computations is also valid for plastic yielding. Furthermore, a series of derivative models were created which have similar structure but different porosity values. The analysis of these models showed that yield stress, cohesion and internal friction angle linearly decrease with increasing porosity in the porosity range of between 8% and 28% (Figure 2). The internal friction angle decreases the most significantly, while cohesion remains stable.

<sup>1</sup> School of Earth Sciences and Engineering, Sun Yat-sen University (SYSU), Guangzhou, 510275, China, liujie86@mail.sysu.edu.cn

<sup>2</sup> CSIRO Energy, Perth, Australia, Joel.Sarout@csiro.au

<sup>3</sup> School of Earth Sciences and Engineering, Sun Yat-sen University (SYSU), Guangzhou, 510275, China., 20161602029t@cqu.edu.cn

<sup>4</sup> CSIRO Energy, Perth, Australia, Jeremie.Dautriat@csiro.au

<sup>5</sup> School of Petroleum Engineering, University of New South Wales, Sydney, 2052, Australia & CSIRO Energy, Perth, Australia, e.veveakis@unsw.edu.au

<sup>6</sup> School of Petroleum Engineering, University of New South Wales, Sydney, 2052, Australia, klaus@unsw.edu.au

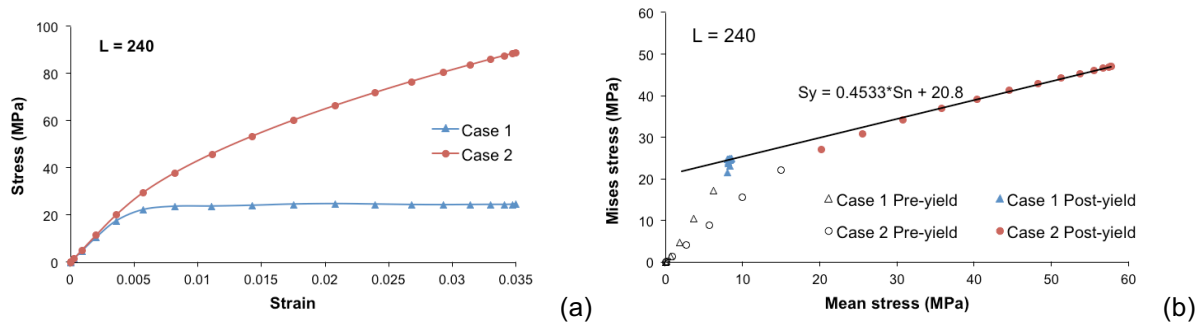

Figure 1. Stress-strain relationships (a) and mean stress vs. Mises stress of the plastic response of the volume of the side-length  $L=240$ . The plateau of (a) corresponds to yield stress ; the fitted relationship in (b) gives a cohesion of 20.8 MPa and a friction angle of  $24.4^\circ$ .

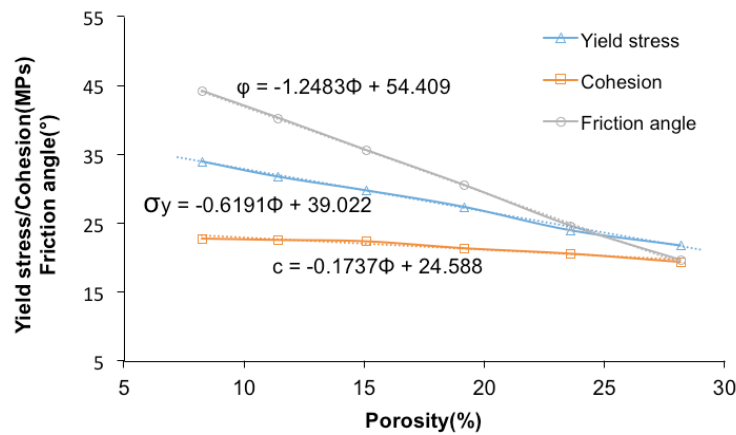

Figure 2. Plastic parameters versus porosity.

Although it is a purely mechanical analysis, this study forms a milestone in the long journey from complex microstructures of rock to coupled THMC at micro-scale and upscaling. The following steps in the way will be 1) mechanical damage related to the geometry of microstructure; 2) coupled damage and fluid interaction in complex microstructures; 3) coupled HMC at micro-scale where damage is included; and 4) coupled THMC at micro-scale and upscaling.

## References

- Regenauer-Lieb, K., A. Karrech, H.Chua, et al. (2010). Time-Dependent, Irreversible Entropy Production and Geodynamics. *Philosophical Transactions of the Royal Society London, A*, 368(1910): 285–300.
- Liu, J., and K. Regenauer-Lieb (2011). Application of percolation theory to microtomography of structured media: Percolation threshold, critical exponents, and upscaling. *Physical Review E - Statistical, Nonlinear, and Soft Matter Physics*, 83, 1–13. doi:10.1103/PhysRevE.83.016106.
- Liu J., R. Freij-Ayoub, K. Regenauer-Lieb (2015). Rock Plasticity from Microtomography and Upscaling, *Journal of Earth Science*, 26(1): 053–059, doi: 10.1007/s12583-015-0520-4.





## GeoProc2017

6th International Conference on Coupled THMC Processes in Geosystems  
5-7 Jul 2017 Paris (France)

### **Fluid-rock interactions in THMC simulations: its numerical challenges and future modeling perspectives**

*A.M.M. Leal<sup>1</sup>, A. Ebigbo<sup>2</sup>, M.O. Saar<sup>3</sup>*

*Keywords: fluid-rock interactions, reactive transport, equilibrium, kinetics, speciation*

Many processes in deep geological formations, such as multiphase flow in fractured porous rock, heat conduction and convection, chemical species transport, and, to some extent, mechanical deformation, can only be accurately modeled if fluid-rock interactions are taken into account. Such interactions occur as a result of geochemical reactions, such as those responsible for dissolution of existing rock-forming minerals and precipitation of secondary formed minerals. The short- and long-term impact of such chemical processes cannot be neglected, as they can create preferential flow paths due to mineral dissolution as well as clog rock pores and reduce fracture apertures as a result of mineral precipitation. These geochemical reactions are thus strongly coupled with the behavior of up-scaled rock properties, such as porosity and permeability, which affect several coupled phenomena. Therefore, simulations of coupled processes can only be claimed to be realistic if geochemical reactions are considered.

The importance and significance of geochemical reactions is even more evident when CO<sub>2</sub> is injected underground. This is commonly done, for example, to enhance oil recovery, to sequester carbon dioxide for climate change mitigation, or to extract geothermal energy both in enhanced geothermal systems (EGS) and in CO<sub>2</sub>-plume geothermal (CPG) systems (Randolph and Saar, 2011). As supercritical CO<sub>2</sub> is injected in the reservoir, it forms a plume that gradually dissolves into the resident brine. As a result, brine is acidified and geochemical reactions are intensified near the interface between CO<sub>2</sub> and water, causing minerals to dissolve. The dissolved minerals will then advect and diffuse as chemical species within the fluid and possibly cause mineral precipitation elsewhere, for example, due to varying temperature and/or pressure conditions the fluid encounters in the reservoir and/or wellbore, or because of local mineral saturation in the fluid.

However, accounting for geochemical reactions in numerical simulations is both realistically challenging and computationally expensive. The reasons are many, ranging from lack of proper upscaling models for updating model parameters such as rock permeability and mineral reactive surface area, to expensive calculations due to chemical systems with many phases (aqueous, gaseous, solid) and several dozens of chemical species that have the potential to exist under a wide range of deep reservoir conditions. Furthermore, such phases might need elaborate thermodynamic models (i.e., equations of state)

<sup>1</sup> ETH Zürich, Geothermal Energy and Geofluids Group, [allan.leal@erdw.ethz.ch](mailto:allan.leal@erdw.ethz.ch)

<sup>2</sup> ETH Zürich, Geothermal Energy and Geofluids Group, [ebigbo@erdw.ethz.ch](mailto:ebigbo@erdw.ethz.ch)

<sup>3</sup> ETH Zürich, Geothermal Energy and Geofluids Group, [saarm@ethz.ch](mailto:saarm@ethz.ch)

to describe their non-ideal behavior as a function of temperature, pressure, and chemical composition. When such models are combined with the rest of the algorithmic calculations to compute the effects of geochemical reactions in all other physical processes, the time spent for chemistry-related calculations could be anywhere from 80% to 99% of the total time spent for the simulation. The reason such chemical calculations take so much time during the simulation is because they are performed at every cell or node of the mesh at every time step, which could be millions of calculations by the end of the simulation. Thus, such calculations need to be as fast as possible. These numbers show that further algorithmic improvements for chemical calculations are timely and essential for THMC simulations.

Chemical processes are modelled with either *chemical equilibrium* or *chemical kinetics*. Ideally, for geochemical systems, a combination of both approaches is preferred. This is because the rates of aqueous and gaseous reactions are orders of magnitude higher than those of mineral dissolution or precipitation reactions. For example, many aqueous reactions equilibrate on the order of microseconds, while days or even years are needed for some mineral dissolution reactions. Therefore, it is reasonable to assume aqueous and gaseous reactions, as well as some fast mineral reactions, to be in equilibrium at all times, while slow mineral reactions are modeled with kinetics.

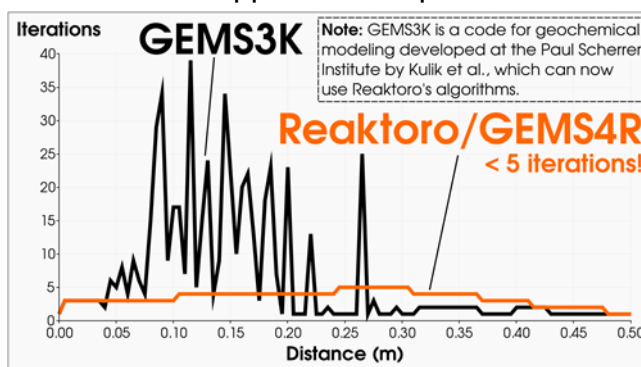

Figure 1. Multiphase equilibrium calculations in a reactive transport simulation: performance comparison between Reaktoro and GEMS3K, the chemical engine of the THMC simulators OpenGeoSys and CSMP++.

**We present novel advances in numerical algorithms for efficient, accurate, and robust computation of chemical equilibrium and kinetics calculations for multiphase complex chemical systems and discuss the innovative features that make them especially suitable for THMC simulators. In particular, we present the recently developed *extended law of mass action (xLMA) method* (Leal et al. 2016a) and the *Gibbs energy minimization (GEM) method* (Leal et al. 2016b), as well as the kinetics method (Leal et al. 2015a) implemented in Reaktoro (Leal 2015b), which were developed particularly with THMC simulations in mind.**

## References

- Leal, A.M.M., D.A. Kulik, G. Kosakowski, and M.O. Saar (2016a), Computational methods for reactive transport modeling: An extended law of mass-action, xLMA, method for multiphase equilibrium calculations, *Adv. Water Resour.*, 96, 405–422, doi:10.1016/j.advwatres.2016.08.008.
- Leal, A.M.M., D.A. Kulik, and G. Kosakowski (2016b), Computational methods for reactive transport modeling: A Gibbs energy minimization approach for multiphase equilibrium calculations, *Adv. Water Resour.*, 88, 231–240, doi:10.1016/j.advwatres.2015.11.021.
- Leal, A.M.M., M.J. Blunt, and T.C. LaForce (2015a), A chemical kinetics algorithm for geochemical modelling, *Appl. Geochemistry*, 55, 46–61, doi:10.1016/j.apgeochem.2014.09.020.
- Leal, A.M.M. (2015b), Reaktoro: A unified framework for modeling chemically reactive systems. [www.reaktoro.org](http://www.reaktoro.org)
- Randolph, J.B., and M.O. Saar (2011), Combining geothermal energy capture with geologic carbon dioxide sequestration, *Geophys. Res. Lett.*, 38(L10401), doi:10.1029/2011GL047265.



## GeoProc2017

6th International Conference on Coupled THMC Processes in Geosystems  
5-7 Jul 2017 Paris (France)

### Fluid pressure feedback on rocks at the micro-scale

*M. Lesueur<sup>1,2</sup>, M. Veveakis<sup>1,2</sup>, T. Poulet<sup>2,1</sup>*

*Keywords: Fluid-Structure Interaction, Viscoplasticity, Euler flow, Micro-CT imaging*

The behaviour of porous rocks in the subsurface is heavily influenced by fluid pore pressure, which can reach high values enough to hydro-frack the rock. Terzaghi (1923) was the first one to propose a law to quantify this influence at the macro-scale that he related directly to the solid stress through the concept of effective stress, defined as

$$\boldsymbol{\sigma}'_s = \boldsymbol{\sigma}_s - p_f \mathbf{I} \quad (1)$$

with  $\boldsymbol{\sigma}'_s$  the effective stress of the solid,  $\boldsymbol{\sigma}_s$  the solid stress and  $p_f$  the pore pressure.

While effective stress proposes a crucial upscaled concept to account for the effect of pore pressure on the mechanical response of rocks, work still remains to be done to fully understand all effects and feedbacks between the pore pressure and mechanical deformation at the micro-scale. In this study, we propose to evaluate this influence directly at the pore-rock interface. In this context, we present a novel numerical simulator to model hydro-mechanical coupling on images reconstructed from computerised tomography images (CT-scans). The simulator uses a finite element implementation of an Eulerian flow solver coupled to a Lagrangian solid mechanics solver, either in a sequentially- or tightly-coupled manner. This implementation can simulate flow and mechanical deformation on 3D meshes reconstructed from a stack of segmented 2D CT-scan images.

The study highlights the importance of considering a tightly-coupled implementation when dealing with strongly non-linear feedbacks between the fluid pressure and mechanical deformation. This is particularly important for the modelling of unconventional reservoirs such as coalbed methane, as illustrated from a synthetic model in Fig 1. We show that Terzaghi's principle (Eq 1) can be retrieved at the CT-scan scale as shown on Fig 2 where the stress-strain curve for the saturated case appears shifted from the unsaturated case by a constant which is interpreted as the macroscopic value of the pore pressure.

This framework is particularly relevant in Petroleum Engineering as part of a multiscale analysis to study the feedbacks of fluids pressures in a fractured reservoir under production such as coalbed methane.

<sup>1</sup> School of Petroleum Engineering, UNSW, Kensington, NSW 2033, Australia

<sup>2</sup> CSIRO, 11 Julius Avenue, North Ryde, NSW 2113, Australia

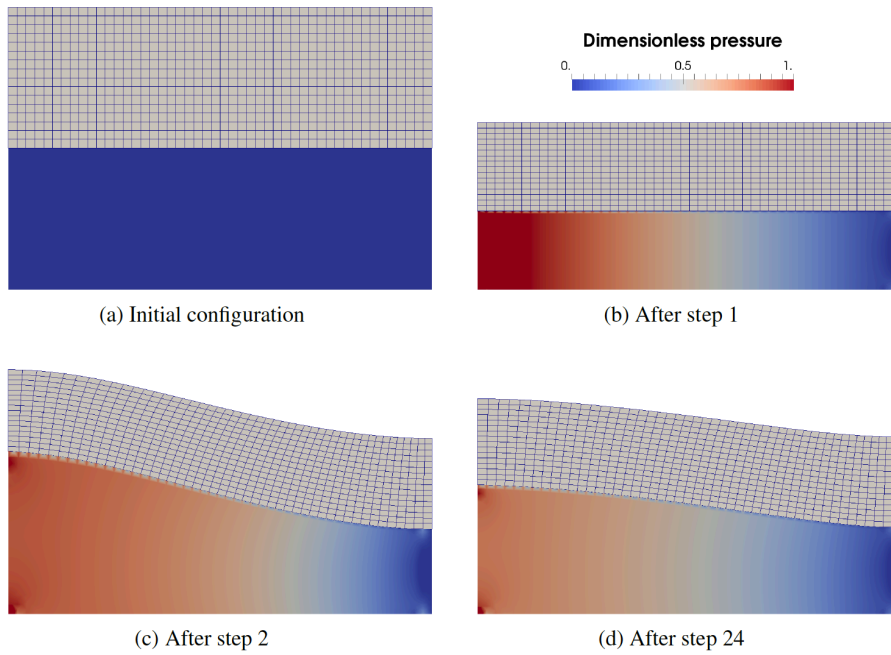

Figure 1. Step by step evolution of sequentially coupled hydro-mechanics. No magnification was applied for visualisation.

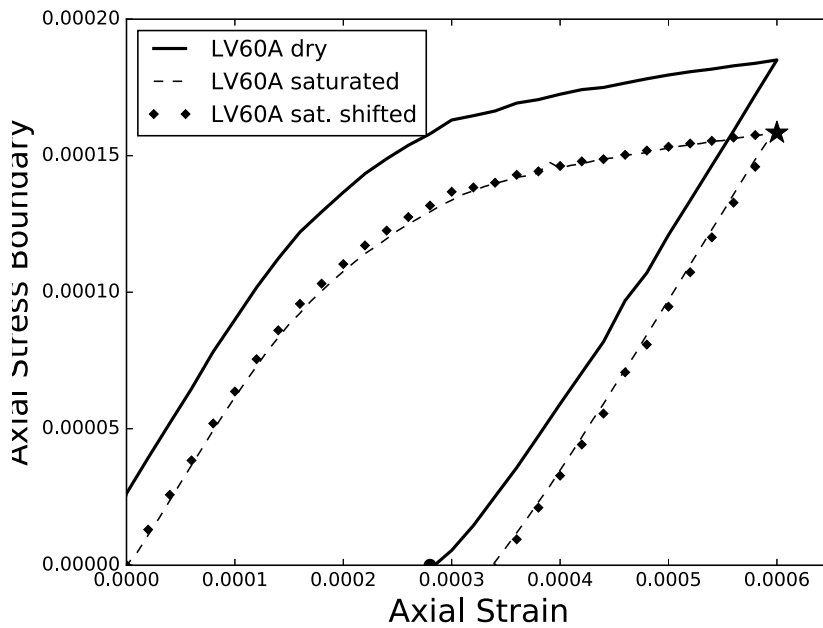

Figure 2. Stress-Strain curve responses for dry and saturated digital rock samples. The dry curve is retrieved when the saturated response is shifted by the pore pressure. The black dot on each figure marks the end of the numerical simulation.

## References

K. v. Terzaghi. Die berechnung der durchlässigkeitsziffer des tones aus dem verlauf der hydrodynamischen spannungsercheinungen. Sitzungsberichte der Akademie der Wissenschaften in Wien, Mathematisch-Naturwissenschaftliche Klasse, Abteilung IIa, 132:125–138, 1923.



## GeoProc2017

6th International Conference on Coupled THMC Processes in Geosystems  
5-7 Jul 2017 Paris (France)

### **Tracer tests and numerical simulations on nonlinear fluid flow behaviors in 2D fracture networks**

*B. Li<sup>1</sup>, Z. Zhong<sup>2</sup>, R. Liu<sup>3</sup>*

*Keywords: Fracture network; Fluid flow; Tracer test; Numerical simulation*

Fluid flow and mass transport behaviors of rock fracture networks are important for safety and stability assessment of various kinds of reservoir engineering, such as nuclear waste disposal and CO<sub>2</sub> sequestration. Single fracture and fracture intersection are two most fundamental elements that constitute rock fracture networks. In the present study, the focus was put on fluid flow behavior of artificial single fracture intersections and upscaling the elemental model to 2-D fracture networks.

Tracer tests were conducted on three crossed fractures with different intersecting angles (60°, 90° and 120°) and a fracture network comprising 41 fractures. These testing models were manufactured by glasses to allow the visualization of fluid flow that was recorded by a CCD camera. Numerical simulations by solving the Navier-Stokes equations were performed to simulate the fluid flow based on the experimental models, and to extensively estimate the effects of geometric characters in fracture networks on the fluid flow behavior.

The tracer test and their numerical simulation results show that when fluid flows through an intersection, the streamline in each branch exhibits a hyperbolic frontline, where the flow velocity at the tip of the frontline is significantly larger than the mean flow velocity. The concentrations of the dye solute near the boundary are lower than those inside due to slight mixing. The influences of intersecting angle on the variation of flow patterns surrounding each intersection are negligible at a necessarily low magnitude of Re, which gradually become significant as the increase of Re.

The relations between permeability of hydraulic gradient for both crossed fracture models and fracture network models exhibit an initial linear regime and a subsequent nonlinear regime. Such transition takes place at some critical values of hydraulic gradient, which have magnitudes around  $10^{-5} - 10^{-3}$ . This is attributed to geometric variations produced by surface roughness of fractures, and intersections, which bring extra frictional loss to flow at high Re. In the present study, since the tested fractures have relatively smooth surfaces, the number of intersections in a model and their geometric characters become the key issue in the nonlinear fluid flow behavior of fracture networks, which need to be quantitatively investigated in future studies.

<sup>1</sup> Shaoxing University, China, libo@usx.edu.cn

<sup>2</sup> Shaoxing University, China, zhongzhen@usx.edu.cn

<sup>3</sup> China University of Mining and Technology, China, my1122002006@126.com

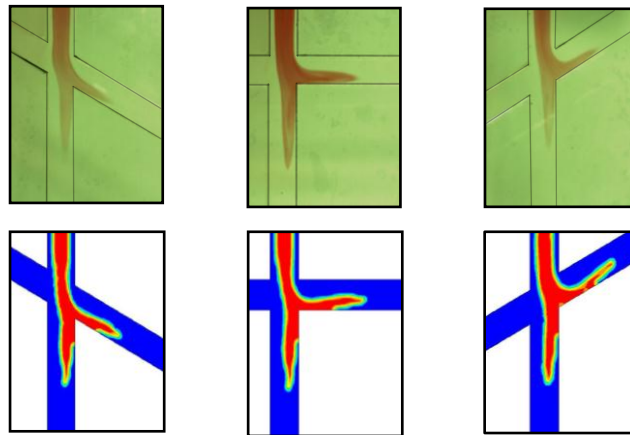

Figure 1. Tracer test and numerical simulation results of fluid flow through single fracture intersections with included angles of 60°, 90° and 120°, respectively.

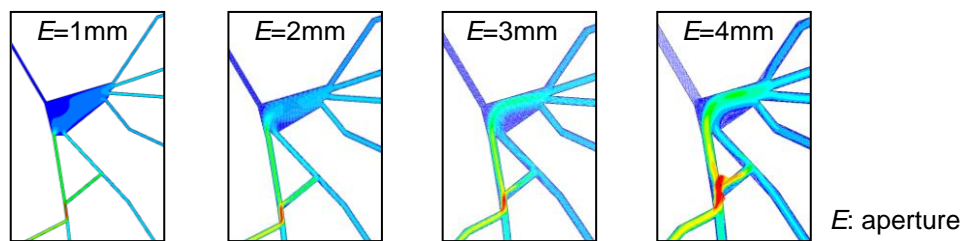

Figure 2. Enlarged view of numerical simulation results of fluid flow through a fracture network.

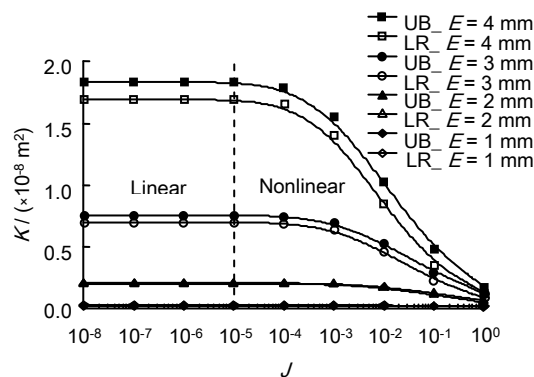
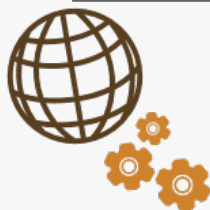

Figure 3. Relationship between permeability and hydraulic gradient for the fracture network.

## References

- Stockman, H.W., J. Johnson, and S.R. Brown (2001), Mixing at fracture intersections: Influence of channel geometry and the Reynolds and Peclet numbers, *Geophys. Res. Lett.*, 28, 4299–4302, doi: 10.1029/2001GL013287.
- Liu, R., Y. Jiang, B. Li (2016), Effects of intersection and dead-end of fractures on nonlinear flow and particle transport in rock fracture networks, *Geosci. J.*, 20, 415–426, doi:10.1007/s12303-015-0057-7.
- Li, B., R. Liu, Y. Jiang (2016), Influences of hydraulic gradient, surface roughness, intersecting angle, and scale effect on nonlinear flow behavior at single fracture intersections, *J. Hydrol.*, 538, 440–453, doi:10.1016/j.jhydrol.2016.04.053.



## GeoProc2017

6th International Conference on Coupled THMC Processes in Geosystems  
5-7 Jul 2017 Paris (France)

### Analytical model of self-sealing process of fractures in claystone

Soheib Maghsoodi<sup>1</sup>, Frédéric-Victor Donzé<sup>2</sup>, Raymi Castilla<sup>3</sup>, Claude Gout<sup>4</sup>

*Keywords: analytical model, self-sealing, fracture, aperture, permeability, claystone*

A key problem is model the self-sealing process occurring in different geological conditions, in order to assess the amount of fluid which can pass through the fractures of these formations (Bock et al, 2010). There is some direct and indirect evidence that fluid-conductive fractures will seal in clayey media (Auvray et al, 2015). An analytical model of self-sealing has been proposed on the basis of experimental experiments (Zhang, 2011). Fractured samples of COX (Argillite) and OPA (Opalinus Clay) samples were used to measure their permeability evolution. Water was injected into the fractured samples with 1 MPa pressure under a confining stress of 2 MPa. An analytical function was formulated to predict the aperture evolution during these hydraulic tests based on the observations. It has been formulated on the basis of an exponential function, such as,

$$A = A_0 e^{-\alpha(t/t_0)^n}$$

Where  $A$  is the aperture of the fracture at time  $t$ ,  $A_0$  is the initial aperture,  $\alpha$  and  $n$  are coefficient and exponent controlling the rate of decay,  $t_0$  is the initial time. The corresponding analytical model proposed for Opalinus clay and Argillite can be expressed as follow,

$$A = 0.004 e^{-1.81(t/t_0)^{0.5}} \text{ for OPA}$$

$$A = 0.001 e^{-1.1(t/t_0)^{0.3}} \text{ for COX}$$

The corresponding curves are presented in Figure 1. Extensions have been also made to take into account a progressive increase of the confinement in a monotonic mode. One of the aims of this study is to show the potential overestimation in fluid migration when self-sealing is not considered. For a given confinement, the amount of flow rate  $Q$  divided by initial flow rate  $Q_0$  for a reference case for which a complete open fracture without considering any effect of self-sealing, (i.e.  $\alpha = 0$ ), is presented in Figure 2 (blue curve

<sup>1</sup> University of Lorraine, soheib.maghsoodi@univ-lorraine.fr

<sup>2</sup> University of Grenoble Alpes, frederic.donze@3sr-grenoble.fr

<sup>3</sup> Total, Jean Feger Scientific and Technical Center, raymi.castilla@total.com

<sup>4</sup> Total, Jean Feger Scientific and Technical Center, claud.gout@total.com

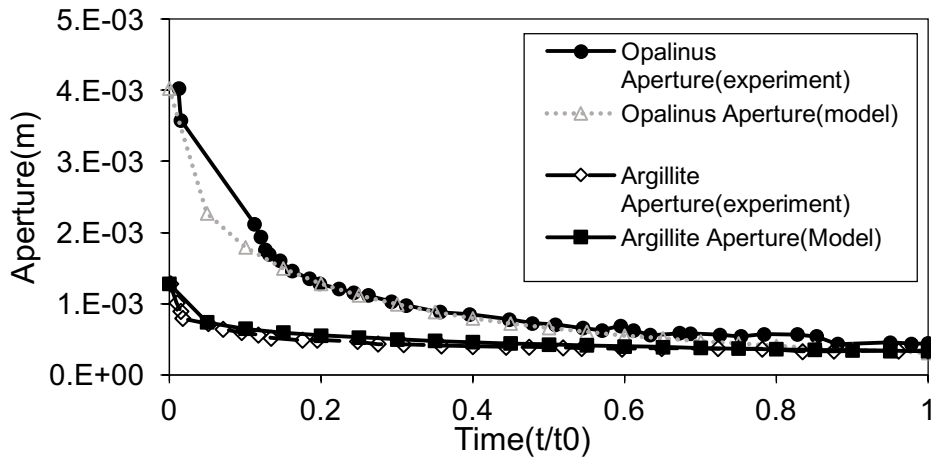

Figure 1. Experimental and analytical results of aperture closure with time for Opalinus clay (OPA) and Argillite (COX).

Compared to this constant aperture case, different closure rate cases (controlled by  $\alpha$ ), are presented on the same figure: for  $\alpha = 1.1$ , representing COX (red curve) or for  $\alpha = 1.8$ , representing OPA (blue dark curve). Considering a reference time of some hundreds of days, the resulting flow rate can exhibit a reduction up to 80%-90% for these types of rocks.

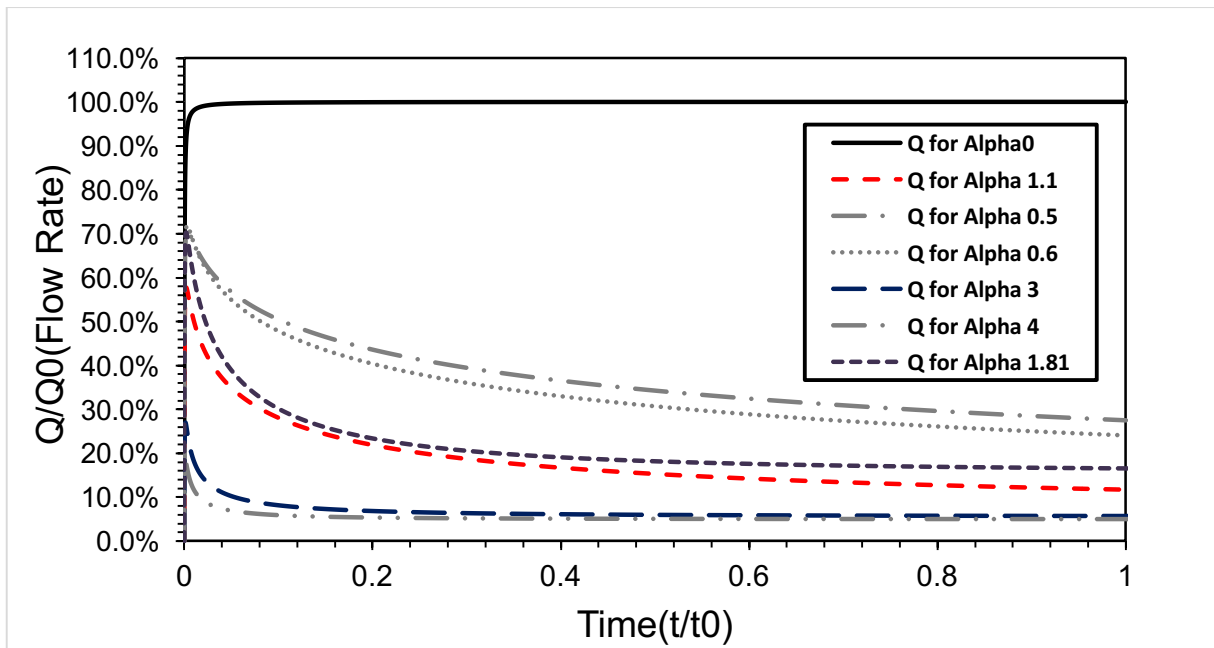

Figure 2.  $Q/Q_0$  for different  $\alpha$  values.

## References

- Bock, H., Dehandschutter, B., Martin, C. D., Mazurek, M., De Haller, A., Skoczylas, F., & Davy, C. (2010). Self-sealing of fractures in argillaceous formations in the context of geological disposal of radioactive waste, Review and Synthesis. Nuclear Energy Agency.
- Auvray, C., Morlot, C., Fourreau, E., & Talandier, J. (2015, January). X-Ray Tomography Applied to Self-Healing Experiments on Argillites. In 13th ISRM International Congress of Rock Mechanics. International Society for Rock Mechanics.
- Zhang, C. L. (2011). Experimental evidence for self-sealing of fractures in claystone. *Physics and Chemistry of the Earth, Parts A/B/C*, 36(17), 1972-1980.





## GeoProc2017

6th International Conference on Coupled THMC Processes in Geosystems  
5-7 Jul 2017 Paris (France)

### **Poroviscoelastic behavior of common sedimentary rock**

*R. Makhnenko<sup>1</sup>, Y. Podladchikov<sup>2</sup>*

*Keywords: Poroviscoelastic model, Experimental Geomechanics, Poroelastic parameters, Bulk viscosity*

Principles behind mathematical models for poroelastic and poroviscoelastic response were recently reviewed. By analogy with Biot's poroelastic relationships, poroviscous model parameter, the bulk viscosity, can be included in the constitutive equations. However, models still require validation and estimation of the viscous parameters. Time-dependent response of fluid-filled sedimentary rocks is experimentally quantified at low temperatures and isotropic stress states. Three poroelastic parameters are measured by drained, undrained, andunjacketed geomechanical tests for quartz-rich Berea sandstone, calcite-rich Apulian limestone, clay-rich material, and Jurassic shale. The bulk viscosity is estimated under constant isotropic stress conditions from time-dependent deformation of rock in the drained regime for time scales on the order of 10<sup>5</sup> seconds. It was found that measurement of this parameter through the observation of the pore pressure growth under undrained conditions is more precise and requires time scales ~ 10<sup>4</sup> s. The bulk viscosity is on the order of ~ 10<sup>15</sup> Pa•s for the sandstone, limestone, and shale, and ~ 10<sup>12</sup> Pa•s for the clay-rich material and decreasing with the increase of pore pressure despite corresponding decrease in the effective stress. Long-term integration in time of these observations would lead to explosive growth of the fluid pressure even under constant isotropic stress, which in natural reservoirs may lead to liquefaction or rock embrittlement causing slip instabilities and earthquakes.

---

<sup>1</sup> Department of Civil & Environmental Engineering, University of Illinois at Urbana-Champaign, USA, romanmax@illinois.edu

<sup>2</sup> Institute of Earth Sciences, University of Lausanne, Switzerland, yury.podladchikov@unil.ch





## GeoProc2017

6th International Conference on Coupled THMC Processes in Geosystems  
5-7 Jul 2017 Paris (France)

### Experimental characterization of THMC behavior in granular uncemented media during heavy oil production (EOR)

*M. Martín<sup>1</sup>, J. Alvarellos<sup>2</sup>, J. Delgado<sup>3</sup>, E. M. Escobar<sup>2</sup>, J.M. Goicolea<sup>1</sup>*

*Keywords: Creep, EOR, Micromechanics, Sand Compressibility, Quartz solubility*

Thermal Enhanced Oil Recovery (EOR) technologies activate Thermo-Hydro-Mechano-Chemical (THMC) processes in the reservoir. It is well known that quartz sand compressibility is dependent on stresses and boundary conditions. However, water saturation, composition, pH and temperature play a significant role on its response. Hence, the increase of intergranular pressure and temperature that occurs during production brings about a series of phenomena at particulate level (crushing, boundary diffusion, pressure-solution and stress-corrosion) that lead to a significant change in soil porosity, permeability, stiffness and strength as a function of time and space.

Sample recovery, handling, gas exsolution and storage, inevitably cause sample disturbance and alter the in situ microfabric being not feasible to reconstitute the sample back to in situ conditions. However, leaving aside costly possible recovery techniques, carefully designed laboratory tests can provide some insight into natural conditions and enable to predict reservoir evolution during EOR. In this regard, in order to uncouple the aforementioned THMC processes, the following laboratory tests have been conducted using sand samples from an oil field which is candidate to a thermal recovery process:

#### **Thermo-Mechanical tests**

Compressibility and crushing tests: Oedometer tests under dry conditions in oil-free sand, monitored by acoustic emissions over a wide range of effective stresses of 0.5-50 MPa and temperature from room temperature up to 250 C, have been carried out. The corresponding grain size distributions have been compared, before and after the tests. As a result, changes in porosity can be inferred by crushing and particle rearrangement.

#### **Thermo-Hydro-Chemical tests**

Tests in autoclave Reactor: An oil-free soil sample in a rotating fine-mesh basket is submerged at approximately 12 MPa for several days at 100, 200 and 300C in a solution with the same composition as the reservoir brine.

From these tests it is possible to determine the relationship between the equilibrium concentration of a solution theoretically in equilibrium with quartz and the experimental one under the stated conditions. As expected, pH and alkali cations yield higher silica concentration than the one corresponding to water. It can be inferred from these tests that the presence of Ca and Mg cations affect the reactivity of quartz cause they exhibit higher equilibrium adsorption coefficients.

(1) Civil Engineering School, Polytechnic University of Madrid (UPM)  
(2) REPSOL S.A.  
(3) Civil Engineering School. University of Coruña (UDC)

## Thermo-Hydro-Mechano-Chemical tests

Oedometer tests in oil-free sand saturated in brine with the reservoir composition: These tests are aimed at assessing the significance of the water composition in the sand compressibility. Tests have been carried out at undrained, drained and water flow conditions. In addition, silica concentration of the outflow water has been determined. As a result, different values in vertical displacement due to water effect are reached by stress-corrosion, pressure-solution and particles rearrangement (figure 1).

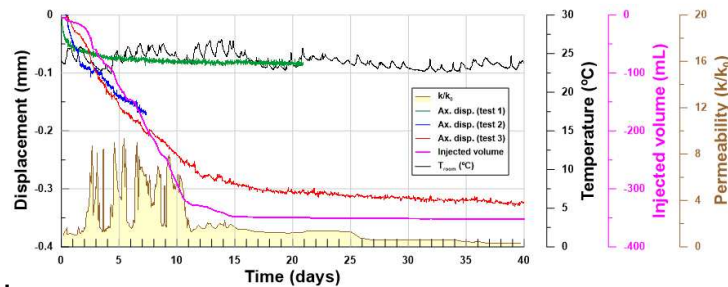

Figure 1. Vertical displacement in oedometer tests at undrained, drained and water flow conditions.

Core flooding test at reservoir pressure: A constant flow of brine through a reconstituted sand plug as the same reservoir porosity has been kept constant for 8 days at 60 and 150 C. Silica concentration has been measured at every residence time. Samples after testing have been observed at CT scan (preserving previously the microfabric generated) and SEM in order to examine the development of interparticle phenomena. Grain size distributions have been compared, before and after the tests. As a result, both stress-corrosion and pressure-solution features are observed.

Taking into account the experiments in which we have tested coupled and uncoupled processes, it turns out that from the mechanical point of view the mere change of temperature is not as significant as the coupled reactivity triggered by thermal increase.

## References

- Chester, F.M., Chester, J.S., Kronenberg, A.K. and Hajash, A. (2007), Subcritical creep compaction of quartz sand at diagenetic conditions: Effect of water and grain size. *J. Geophys. Res. Solid Earth*, **112(B06203)**: 1-15, doi:10.1029/2006JB004317.
- Dove, P.M., Nix, C.J. (1997), The influence of the alkaline earth cations, magnesium, calcium and barium on the dissolution kinetics of quartz. *Geochimica et Cosmochimica Acta*, **61(16)**: 3329-3340.
- Freeman, B. (1986), Deformation mechanism maps and micromechanics of rocks with distributed grain sizes. *J. Geophys. Res. Solid Earth*, **91(B3)**: 3849-3860.
- McClay, K.R. (1977), Pressure solution and Coble creep in rocks and minerals: a review. *J. Geol. Soc. London* **134**: 57-70.
- McDovell, G.R. and Bolton, M.D. (1998), On the micromechanics of crushable aggregates. *Géotechnique*, **48(5)**: 667-679, doi:10.1680/geot.1998.48.5.667.
- Mesri, G. and Vardhanahuti, B. (2009), Compression granular materials. *Can. Geotech. J.* **46(4)**: 369-392, doi:10.1139/T08-123.
- Schutjens, P.M. T.M. (1991), Experimental compaction of quartz sand at low effective stress and temperature conditions. *J. Geol. Soc.* **148**: 527-539, doi: 10.1144/gsjgs.148.3.0527.
- Wheeler J (1992) Importance of pressure solution and Coble creep in the deformation of polymineralic rocks. *J. Geophys. Res. Solid Earth* **97(B4)**: 4579-4586.



## GeoProc2017

6th International Conference on Coupled THMC Processes in Geosystems  
5-7 Jul 2017 Paris (France)

### **Numerical THM Modelling of Performance of Radially Jet-Drilled Laterals in Chalk Reservoirs**

*M.K.Medetbekova<sup>1</sup>, S.Salimzadeh<sup>2</sup>, M.H.Nick<sup>3</sup>*

*Keywords: Radial Jet Drilling, chalk reservoir, damage model, Thermo-Hydro-Mechanical processes*

Radial Jet Drilling is a cost efficient technique that uses a high-pressure water jet to drill radial laterals in one layer or in multiple layers from the main wellbore. The laterals can be drilled relatively fast, penetrating up to 100 - 200m, in up to 16 directions (Buset et al, 2001), thus RJD has become a very attractive well stimulation candidate for both hydrocarbon reservoirs (Buset et al, 2001 ; Kamel, 2014) and geothermal systems (Peters et al, 2015). However, production data from several successfully implemented RJDs shows an immediate increase in the production rates, followed by a fast decrease within one or two years after the implementation (Ragab, 2013). Due to its small size, laterals are prone to fail under stress, pressure and temperature perturbations.

In this study, a coupled thermo-hydro-mechanical (THM) numerical finite element model is developed to assess the induced damage and progressive failure around the jetted holes under service loading (Figures 1, 2). The induced damage to the rock surrounding the lateral could occur during drilling the lateral, as well as during injecting/producing fluids under non-isothermal conditions. The drilling is performed by jetting either water or acid, depending on the rock type. For chalk reservoirs, jetting acid might be inevitable in order to successfully drill the laterals. The injected water for either enhanced oil recovery (EOR) or geothermal doublet is relatively colder than the in situ temperature in North Sea. Therefore, thermal stresses can be important in damaging laterals in the injection wells, while pressure decline is affecting the stability of the laterals in the production wells. The proposed numerical model predicts induced damage to the laterals, due to thermo-hydro-mechanical loadings. The model is implemented in a robust finite element code, Abaqus. The outcome of this model is used in a reservoir simulator to predict the performance of the laterals in their lifetime in chalk reservoirs.

---

<sup>1</sup>Centre for Oil and Gas, Technical University of Denmark, maiyam@dtu.dk

<sup>2</sup>Centre for Oil and Gas, Technical University of Denmark, saeed@dtu.dk

<sup>3</sup>Centre for Oil and Gas, Technical University of Denmark, hamid@dtu.dk

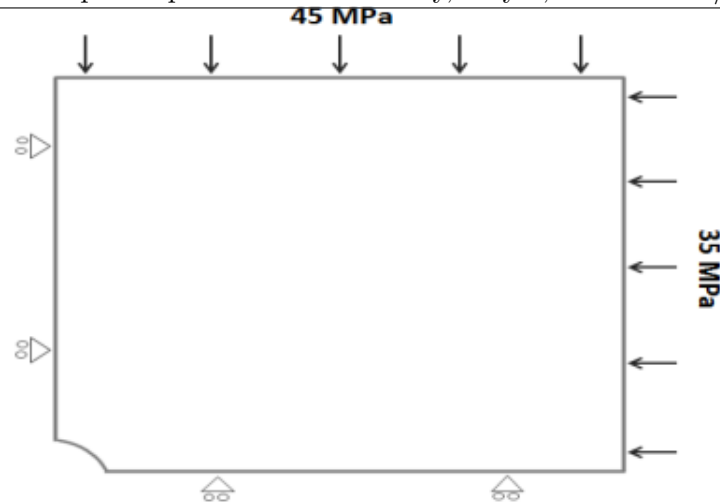

Figure 1 Numerical model setup, boundary conditions and loading

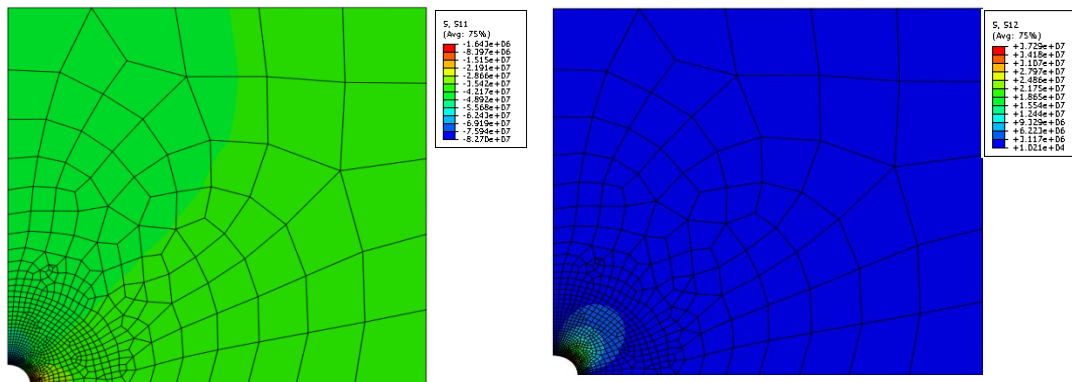

Figure 2 Horizontal (left) and shear stress (right)

## References

- Buset P., Riiber M., Eek A. (2001), Jet Drilling Tool: Cost-Effective Lateral Drilling Technology for Enhanced Oil Recovery. SPE/ICoTA Coiled Tubing Roundtable, Houston, Texas.
- Kamel A.H. (2014), RJD revitalizes mature Kansas oilfield. Oil & Gas Journal 112(10).
- Peters E., Veldkamp J.G., Pluymaekers M.P.D., Wilschut F. (2015), Radial drilling for Dutch Geothermal Applications.
- Ragab, A. (2013), Improving well productivity in an Egyptian oil field using radial drilling technique. Journal of Petroleum and Gas Engineering, vol. 4(5), 103-117 pp, Doi: 10.5897/JPG2013.0153.



## GeoProc2017

6th International Conference on Coupled THMC Processes in Geosystems  
5-7 Jul 2017 Paris (France)

### Thermal shear reactivation in the Callovo-Oxfordian claystone

*H. Menaceur<sup>1</sup>, P. Delage<sup>2</sup>, N. Conil<sup>3</sup>, A.M. Tang<sup>4</sup>*

*Keywords: Nuclear waste disposal, Excavated Damaged Zone, temperature increase, reactivation*

The Callovo-Oxfordian (COx) claystone is a potential host rock for deep geological repository of radioactive waste in France because of its low permeability, good self sealing properties and good radionuclide adsorption capacity. In the close field, an Excavated Damaged Zone (EDZ) develops around the galleries (Armand et al. 2014), that will afterwards be submitted to temperature elevation due to the exothermic nature of the wastes. This contribution is devoted to the thermal reactivation of shear planes comparable to that existing in the EDZ. To do so, a new hollow cylinder triaxial apparatus was used (Monfared et al. 2011). This system has an enhanced drainage system on the lateral faces of the hollow cylinder (70 mm in height, 60 mm in inner and 100 mm in outer diameter) that reduces to 10 mm the drainage length (half the thickness of the hollow cylinder), allowing for reasonably fast saturation (under in-situ stress conditions) and satisfactory drainage during shear.

Following Monfared et al. (2012) on the Boom clay, a stress path including:

- A resaturation phase at 25°C under a Terzaghi mean effective stress  $p'$  close to in-situ stress conditions (confining stress of 9 MPa and pore pressure of 1 MPa);
- A drained shear phase under the same constant mean effective stress;
- A stress release under constant axial deformation down to a shear stress  $q$  of 7.3 MPa;
- An undrained heating phase up to 80°C at a heating rate of 1°C/h;
- A decrease in temperature while bringing back the specimen under isotropic stress.

The results of the undrained heating phase are showed in Figure 1 in terms of change in shear stress with temperature (a), increase in pore pressure due to thermal pressurization (b) and changes in axial and radial strain, from local LVDT measurements (c). One can observe that, due to thermal pressurisation, the pore pressure increases from the initial 1 MPa value to 1.5 MPa when temperature goes from 25 to 28.5°C, while the shear stress increases up to a peak at 7.8 MPa after a first slight decrease to 7.1 MPa, to finally quasi-linearly decrease down to 5.3 MPa at 80°C. This peak corresponds to a

<sup>1</sup> Ecole des Ponts ParisTech, Laboratoire Navier/CERMES, France, pierre.delage@enpc.fr

<sup>2</sup> Ecole des Ponts ParisTech, now at LEMTA, France, Université de Lorraine, hamza.menaceur@univ-lorraine.fr

<sup>3</sup> Andra, Bure, France, nathalie.conil@andra.fr

<sup>4</sup> Ecole des Ponts ParisTech, Laboratoire Navier/CERMES, France, anh-minh.tang@enpc.fr

first peak in thermal pore pressure, that afterwards slightly increases. Inspection of the changes in strains also show that nothing occurs during the thermal pressurization, whereas the shear plane is reactivated after the peaks. Note that these data are rather indicative of the change in displacements that correspond to the remobilization of the shear plane, with a mutual sliding of the parts of the sheared specimen along the plane.

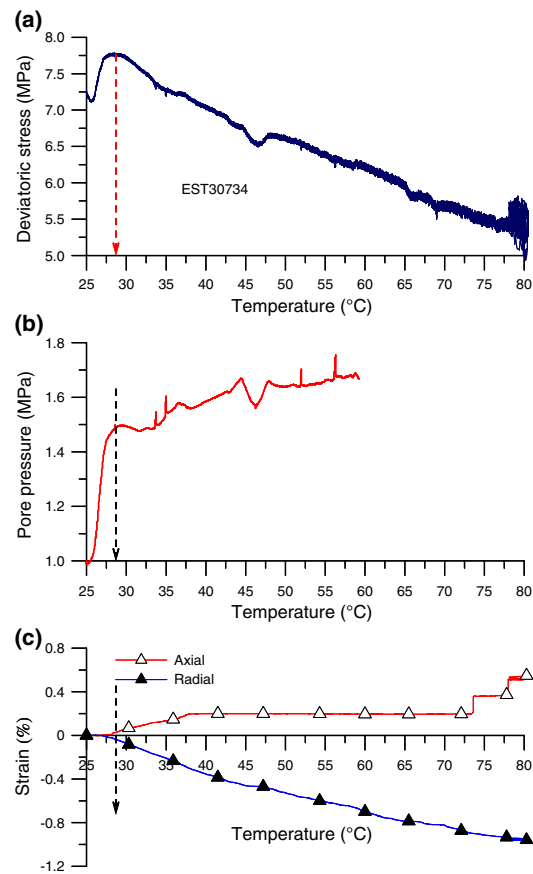

Figure 1. Thermal reactivation of the shear plane.

The rate of thermal pressurization  $\Delta$  derived from Fig. 1b is of 0.156 MPa/°C between 25 and 28.5°C, comparable to the values obtained by Mohajerani et al. (2012) on the COx claystone. The stress path followed in a  $q/p'$  plane indicated a decrease in effective stress with a linear section defined by an equivalent friction angle of 24.7°.

These data, that evidence the thermal reactivation of the shear plane, are useful to better understand the response of the EDZ during the thermal phase of the disposal.

## References

- Armand G., Leveau F., Nussbaum C., De La Vaissière R., Noiret A., Jaeggi D. et al (2014) Geometry and properties of the excavation-induced fractures at the Meuse/Haute-Marne URL drifts. *Rock Mech. Rock Eng.* 47:21–41.
- Mohajerani M., Delage P., Monfared M., Tang A.M., Sulem J., Gatmiri B. (2012). A laboratory investigation of thermally induced pore pressures in the Callovo-Oxfordian claystone. *Int. J. Rock Mech. Min. Sci.* 52:112–121.
- Monfared M., Delage P., Sulem J., Mohajerani M., Tang A.M., De Laure E. (2011). A new hollow cylinder triaxial cell to study the behaviour of geomaterials with low permeability. *Int. J. Rock Mech. Min. Sci.* 48(4):637–649.
- Monfared M., Sulem J., Delage P., Mohajerani M. (2012). On the THM behaviour of a sheared Boom clay sample: application to the behaviour and sealing properties of the EDZ. *Eng. Geol.* 124:47–58.





## GeoProc2017

6th International Conference on Coupled THMC Processes in Geosystems  
5-7 Jul 2017 Paris (France)

### Reactive flow patterns in fractured media

J. Mindel<sup>1</sup>, T. Driesner<sup>2</sup>

*Keywords: Hydrothermal systems, reactive transport, fractured media, numerical modeling*

Understanding the interaction of coupled processes such as mineral precipitation and dissolution, fluid flow, thermal effects, buoyancy, and mechanics is key for risk assessment and planning of Enhanced Geothermal Systems (EGS). With this idea in mind, we created the prototype of a 3D reactive transport simulation tool in which faults and fractures can explicitly be represented within a porous matrix. In order to understand how geometric complexity of the fractures affects reactive transport in a hydrothermal system context, we performed a series of simulations using a benchmark

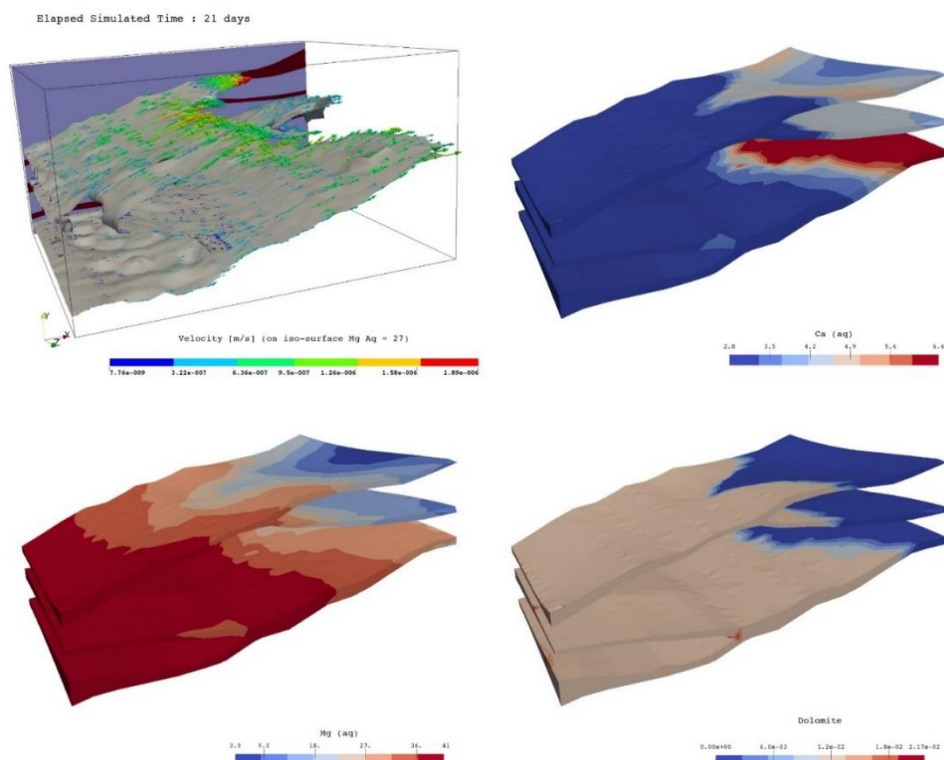

Figure 1 : Reaction progress in the branching faults model. Top left: fluid velocity projected onto a surface representing equal Mg concentration in the fluid (grey); Top right: aqueous Ca mimicking calcite dissolution; Bottom left: aqueous Mg; Bottom right: dolomite distribution.

<sup>1</sup> ETH Zürich, [julian.mindel@erdw.ethz.ch](mailto:julian.mindel@erdw.ethz.ch)

<sup>2</sup> ETH Zürich, [thomas.driesner@erdw.ethz.ch](mailto:thomas.driesner@erdw.ethz.ch)

chemical system from the literature that avoids the additional complications from non-linear feedbacks between changing porosity and transport.

We designed synthetic geometries to study the propagation of reaction fronts using the chemical conditions of the benchmark by Engesgaard and Kipp (1992). Conditions chosen in that benchmark minimize feedbacks such as those resulting from porosity changes. The simulator was constructed using CSMP++ library-based tools (Paluszny et al., 2007), honoring the governing equations for compressible porous media flow and chemical transport (Geiger et al., 2006; Weis et al., 2014), and in conjunction with GEMS software library for chemical modelling (Kulik et al., 2013).

Among other insights, results from simulations demonstrate strong heterogeneity of chemical reaction front advancement, as shown in Figure 1, due to thickness variations inside the fracture zones, their orientation in the fluid pressure field, and the effects of branching on fluid pressure gradients. This work is a further step towards modeling reactive transport with realistic representations of discrete networks of thin fractures in large porous rock masses.

## References

- Engesgaard, P., and K. L. Kipp (1992), A geochemical transport model for redox-controlled movement of mineral fronts in groundwater flow systems: A case of nitrate removal by oxidation of pyrite, *Water Resour. Res.*, 28(10), 2829–2843, doi:10.1029/92WR01264.
- Geiger, S., Driesner, T., Heinrich, C.A., Matthai, S.K. (2006), Multiphase thermohaline convection in the Earth's crust: I. A new finite element - finite volume solution technique combined with a new equation of state for NaCl-H<sub>2</sub>O. *Transport in Porous Media*, 63, 399–434, doi: 10.1007/s11242-005-0108-z
- Kulik D.A., Wagner T., Dmytrieva S.V., Kosakowski G., Hingerl F.F., Chudnenko K.V., Berner U. (2013): GEM-Selektor geochemical modeling package: revised algorithm and GEMS3K numerical kernel for coupled simulation codes, *Computational Geosciences*, 17:1-24, doi: 10.1007/s10596-012-9310-6
- Paluszny, A., Matthai, S.K., Hohmeyer, M., (2007), Hybrid finite element–finite volume discretization of complex geologic structures and a new simulation workflow demonstrated on fractured rocks. *Geofluids*, 7: 186–208. doi:10.1111/j.1468-8123.2007.00180.x
- Weis, P., Driesner, T., Coumou, D., Geiger, S., (2014), Hydrothermal, multiphase convection of H<sub>2</sub>O-NaCl fluids from ambient to magmatic temperatures: a new numerical scheme and benchmarks for code comparison, *Geofluids*, 14(3): 347–371, doi: 10.1111/gfl.12080



## GeoProc2017

6th International Conference on Coupled THMC Processes in Geosystems  
5-7 Jul 2017 Paris (France)

### Tip asymptotic of a hydraulic fracture driven by a power law fluid accounting for the presence of a fluid lag

F-E. Moukhtari<sup>1</sup>, B. Lecampion<sup>1</sup>

*Keywords: Hydraulic fracture mechanics, Complex fluid rheology, The tip region solution, Fluid-solid coupling, Numerical Modeling.*

We investigate the tip region of a hydraulic fracture driven by a power law fluid propagating at a constant velocity  $V$  in an impermeable linear elastic isotropic medium. We account for the presence of a fluid lag of a priori unknown length at the tip of the fracture. The fluid pressurized fracture propagates perpendicular to the far-field compressive minimum stress  $\sigma_o$  in pure opening mode. The solution of this semi-infinite hydraulic fracture problem combines elastic deformation, lubrication flow in the filled region of the fracture and the quasi-static equilibrium fracture propagation condition. It exhibits a multiscale structure related to the strong fluid solid coupling at play near the fracture tip. For a Newtonian fluid, the solution derived by Garagash & Detournay (2000) transition from the classical linear elastic fracture mechanics asymptote near the fracture tip to the viscous asymptote (Desroches et al., 1994) away from the tip (see Fig.1a). The fluid lag was shown to vanish for large values of a dimensionless fracture toughness encapsulating all the problem parameters (viscosity, fracture velocity, plane-strain elastic modulus).

A lot of fluid used in industrial practice exhibit a shear-thinning rheology. Here, we extend the solution previously obtained for a Newtonian fluid to the case of a power-law shear-thinning fluid. For such a rheology, in simple shear, the fluid shear rate  $\tau$  is related to the shear rate  $\dot{\gamma}$  as:

$$\tau = M\dot{\gamma} \quad (1)$$

where  $n$  is the fluid power law index ( $n \in [0,1]$  for shear-thinning fluid) and  $M$  is the consistency index. We formulate the governing equations of the problem and derive a dimensionless form of these equations which only depends on the value of the power law index  $n$  and a dimensionless toughness  $\kappa$  defined as:

$$\kappa = 4 \left( \frac{2}{\pi V} \right)^{\frac{1}{2}} \left( \frac{\sigma_o^{2-n}}{M' E'^{n+1}} \right)^{\frac{1}{2n}} K_{IC} \quad (2)$$

<sup>1</sup>Geo-Energy Laboratory – Gaznat Chair on Geo-Energy, École Polytechnique Fédérale de Lausanne (EPFL), EPFL-ENAC-IIC-GEL, Station 18, CH-1015 Lausanne, Switzerland (fatima-ezzahra.moukhtari@epfl.ch)

where  $E'$  is the plain strain elastic modulus,  $K_{IC}$  is the mode I fracture toughness and  $M' = \frac{2^{n+1}(2n+1)^n}{n^n} M$ . The fracture width  $w$  and net pressure  $p = p_f - \sigma_o$  are scaled by  $\sigma_o/E' L_M$  and  $\sigma_o$  respectively, while the spatial coordinate  $x$  and the fluid lag size  $\lambda$  are scaled by the following viscous lengthscale  $L_M$  defined as

$$L_M = V \left( \frac{M'}{\sigma_o} \right)^{\frac{1}{n}} \left( \frac{E'}{\sigma_o} \right)^{\frac{n+1}{n}}. \quad (3)$$

The integral elasticity equation is discretized using Gauss-Chebyshev polynomials (e.g. Ioakimidis & Theocaris, 1980). We notably transform the coordinates from the semi-infinite interval  $[0, \infty[$  to the finite interval  $[-1, 1]$  and use classical Gauss-Chebyshev method for solving singular integral equations for finite fractures. The lubrication flow equation is discretized using centered finite difference. For a given dimensionless lag, the resulting non-linear system of equations is solved via a quasi-Newton root-finding scheme using the dimensionless toughness and the dimensionless net pressure at the collocation points as the primary unknown variables. For a given value of the dimensionless fluid lag and power law index, our numerical results include the fracture opening  $w$  and fluid pressure  $p_f$  profiles over the whole fracture as well as the corresponding value of the dimensionless toughness.

Our results show that the solution is not only consistent with the square root singularity of linear elastic fracture mechanics near the tip ( $x \ll L_M$ ), but that its asymptotic behaviour in the far field ( $x \gg L_M$ ) corresponds to the solution of a semi-infinite hydraulic fracture driven by a power-law fluid constructed on the assumptions of zero toughness and zero fluid lag (Desroches et al., 1994). Our results also document how the power-law index modifies the variation of the lag size as a function of the dimensionless toughness  $\kappa$ , and its disappearance for large value of  $\kappa$  (see Fig.1b).

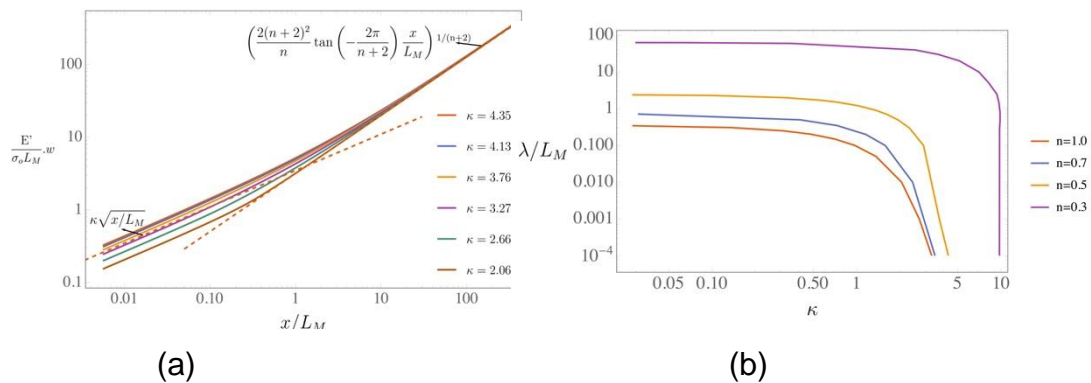

Figure 1. Semi-infinite fluid-driven fracture propagating at constant velocity  $V$  in an impermeable medium: a. Dimensionless opening (in log-log scale) along the fracture for different value of dimensionless toughness ( $n = 0.5$ ), b. Evolution of the dimensionless lag as function of the dimensionless toughness (in log-log scale) along the fracture for different power-law index  $n$ .

## References

- Garagash, D. & Detournay, E. 2000: The tip region of a fluid-driven fracture in an elastic medium. *Journal of applied mechanics* 67(1), 183–192.
- Desroches, J. & Detournay, E. & Lenoach, B. & Papanastasiou, P. & Pearson, J. & Thiercelin, M & Cheng, A. 1994: The crack tip region in hydraulic fracturing. In *Proceedings of the Royal Society of London A: Mathematical, Physical and Engineering Sciences* 447, 39–48.
- Ioakimidis, N. & Theocaris, P. 1980: The practical evaluation of stress intensity factors at semi-infinite crack tips. *Engineering Fracture Mechanics* 13(1), 31–42.



## GeoProc2017

6th International Conference on Coupled THMC Processes in Geosystems  
5-7 Jul 2017 Paris (France)

### Energy-based approaches for the computation of fracture parameters in poroelastic media

Morteza Nejat<sup>1</sup>, Thomas Driesner<sup>2</sup>

*Keywords: poroelasticity, fracture, J-integral, stress intensity factor*

Accurate computation of fracture parameters like energy released rate and stress intensity factor is essential for a reliable modeling of fracture growth using numerical technologies like finite element method. These fracture parameters are often calculated based on contour or domain versions of J- or interaction integrals. One characteristic of these integrals is that if proper additional integral terms are employed, the outcoming values of J- and interaction integrals would be path-independent, indicating that further contours or larger domains can be potentially used. This is crucial for the accurate calculation of fracture parameters since the numerical errors are significantly higher near the crack tip.

In the context of linear elasticity, the J-integral is equivalent to the energy released rate of self-similar crack growth and is defined as (1, 2):

$$G = J = \lim_{\Gamma \rightarrow 0} \int_{\Gamma} \left( W \delta_{1i} - \sigma_{ij} \frac{\partial u_i}{\partial x_1} \right) n_j d\Gamma \quad (1)$$

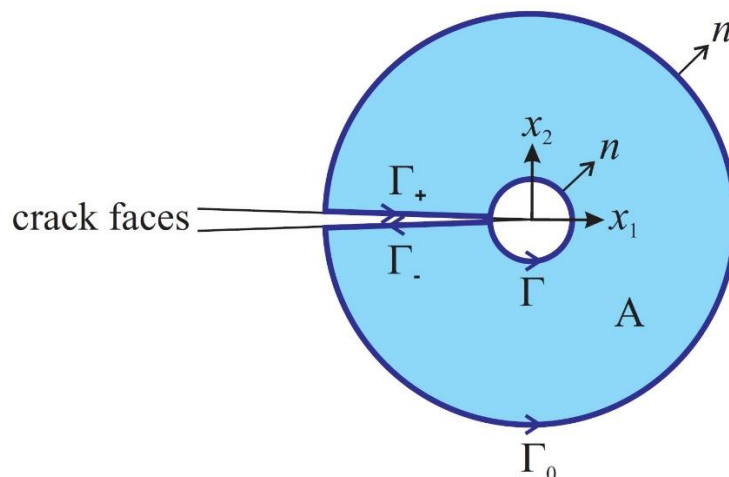

Figure 1. Contour and domain integrals for the evaluation of J- or interaction integrals.

<sup>1</sup> Swiss Competence Center for Energy Research, ETH Zurich, mnejati@ethz.ch

<sup>2</sup> Swiss Competence Center for Energy Research, ETH Zurich, thomas.driesner@erdw.ethz.ch

Here,  $W$  is the strain energy density function,  $\sigma_{ij}$  is the Cauchy stress tensor,  $u_i$  is the displacement vector, and  $n$  is the normal vector to the contour  $\Gamma$  (see Figure 1). In the absence of body force and surface tractions, the intergal in (1) is path-independent for pure mechanical loads (no thermoelasticity or poroelasticity). However, in the case of poroelastic deformation, an additional term is required, which includes the contribution of pore pressure :

$$J = \int_{\Gamma_0} \left( W_m \delta_{1i} - \sigma_{ij} \frac{\partial u_i}{\partial x_1} \right) n_i d\Gamma + \int_A \frac{\alpha}{3K} \sigma_{ii} \frac{\partial p}{\partial x_1} dA \quad (2)$$

Here,  $W_m$  is the mechanical strain energy density function,  $\alpha$  is the Biot's coefficient,  $K$  is the bulk modulus, and  $p$  is the pore pressure.  $A$  is the domain surrounded by  $\Gamma_0$  while  $\Gamma$  is shrunk into the crack tip. The additional term makes the J-integral evaluation path-independent. To the best of our knowledge, the necessity of this term has not been addressed before in literature. Equation (2) has also a domain integral form which is more suitable for finite element calculations:

$$J = \int_{\Gamma} \left( \sigma_{ij} \frac{\partial u_i}{\partial x_1} - W_m \delta_{1i} \right) \frac{\partial q}{\partial x_i} dA + \int_A \frac{\alpha}{3K} \sigma_{ii} \frac{\partial p}{\partial x_1} dA \quad (3)$$

Here, the contour integral in Eq. (2) is transformed into an area integral using an arbitrary continuously differentiable scalar function  $q$  which is equal to unity at the crack tip, while it holds zero along  $\Gamma_0$ . In cases where the computation of stress intensity factors is of main interest, the usage of interaction integral is more convenient since it can compute decomposed modal stress intensity factors. This integral is defined as:

$$I = \int_{\Gamma} \left( \sigma_{ij} \frac{\partial u_i^{aux}}{\partial x_1} + \sigma_{ij}^{aux} \frac{\partial u_j}{\partial x_1} - W_{Im} \delta_{1i} \right) \frac{\partial q}{\partial x_i} dA + \int_A \frac{\alpha}{3K} \sigma_{ii}^{aux} \frac{\partial p}{\partial x_1} q dA \quad (4)$$

Here  $u_i^{aux}$  and  $\sigma_{ij}^{aux}$  are the components of auxiliary displacement vector and stress tensor in a desired crack deformation mode, and  $W_{Im}$  is the mutual mechanical strain energy density function. Once the  $I$  integral is evaluated from Eq. (4), the corresponding stress intensity factor can be calculated. As is seen, the second integral in Eq. (4) considers the contribution of the pore pressure in the total integral evaluation. Therefore, neglecting this term can result in inaccuracies for the calculation of stress intensity factors. This paper will discuss the importance of the additional integral based on the numerical results on coupled poroelastic deformation near the crack tip.

## References

- Shih, C. Moran, B, Nakamura, T., 1986. Energy release rate along a three-dimensional crack front in a thermally stressed body. *International Journal of Fracture* 30, 79-102.
- Nejati, M., Paluszny A., Zimmerman, R.W., 2015. A disk-shaped domain integral method for the computation of stress intensity factors using tetrahedral meshes. *International Journal of Solids and Structures* (69-70), 230-251.



## GeoProc2017

6th International Conference on Coupled THMC Processes in Geosystems  
5-7 Jul 2017 Paris (France)

### Numerical modeling of rock fracturing in geothermal systems

*D.T. Ngo<sup>1</sup>, F.L Pellet<sup>2</sup>, D. Bruel<sup>3</sup>*

*Keywords: Geoenergy, Sismicity, Hydraulic Stimulation, Acoustic Emission, Dynamic*

Geoenergy is one of the most promising techniques to exploit renewable energy resources from the Earth in order to limit emissions of green house gas. It can be considered as base load energy, nearly CO<sub>2</sub> free. In geothermal projects Hydraulic Stimulation (HS) is frequently used to develop naturally fractured reservoir. The basic idea of HS is to pump water with sufficient pressure into the target massif to create a new large scale structure cutting through both injection and production wells. The newly created structure aggregates pre-existent fractures and fresh fractures and should provide sufficient area for heat transfer between water and rock with minimum loss of water from the system. Therefore predicting the fracture propagation during HS process within a given stress field context has become a task of paramount importance.

Rock fracturing due to HS is a multiphysical phenomenon involving coupled thermo-hydro-mechanical processes. Modeling the fracturing of rock requires tracking of the singularities of stresses ahead of a moving fracture. Many methods have been derived to deal with the problem such as finite element method, discrete element method (Cundall & Hart, 1992) or hybrid finite-discrete element method (Lisjak et al., 2017; Munjiza, 2004). The inherent shortcoming of these methods is that the fracture path is mesh-dependent due to methods' assumptions. In our research, eXtended Finite Element Method (XFEM) is chosen because of its advantageous aspects including its capability of capturing the stress singularities and allowing arbitrary propagation of fracture.

In this paper, we present numerical simulations of crack initiation and propagation in lab tests (uniaxial compressive test – UCT- and Brazilian test) performed on hard crystalline rocks. We examined some different criteria for crack initiation based on both tensile stress and shear stress. The tension-based crack initiation criterion is appropriate to model crack growth in Brazilian test. The crack initiated from the central part where tensile stress dominated and then propagated along the diametrical direction through the disc. But when applied to UCT this criterion gives unrealistic cracks. An alternative criterion based on shear stress of Mohr-Coulomb type is proposed and more realistic results were obtained. Moreover rock fracturing is an unstable process, thus dynamic effects are accounted for in the model. Great

<sup>1</sup> Mines ParisTech - PSL Research University, dac-thuong.ngo@mines-paristech.fr

<sup>2</sup> Mines ParisTech - PSL Research University, frederic.pellet@mines-paristech.fr

<sup>3</sup> Mines ParisTech - PSL Research University, dominique.brueel@mines-paristech.fr

attention is paid to the crack propagation in correlation with induced acoustic emission. The last part of the paper is devoted to the upscaling to a geothermal reservoir, accounting for the initial stress regime.

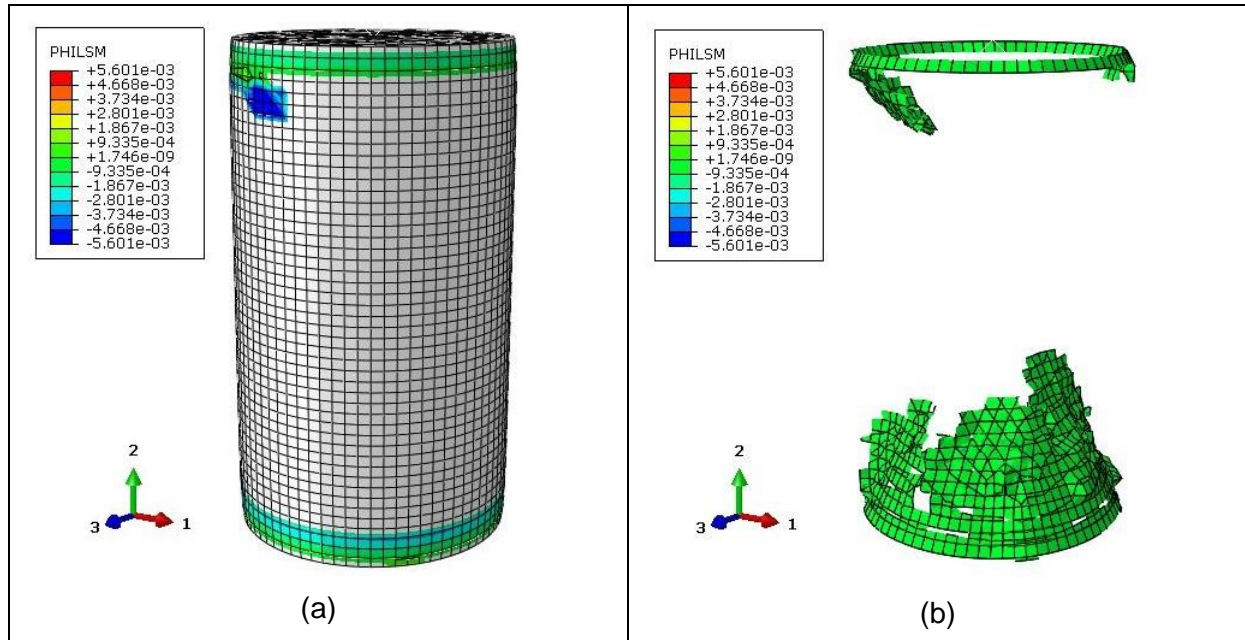

Crack initiation and propagation in Unconfined Compressive Test: a) Crack initiation location (colored zones); b) Crack profile

## References

- Cundall, P. A., and Hart, R. D. (1992). Numerical modeling of discontinua, *Engineering Computations*, 9 (2), 101–113.
- Lisjak, A., Kaifosh, P., He, L., Tatone, B. S. A., Mahabadi, O. K., and Grasselli, G. (2017). A 2D, fully-coupled, hydro-mechanical, FDEM formulation for modelling fracturing processes in discontinuous, porous rock masses. *Computers and Geotechnics*, 81, 1–18.
- Munjiza, A. (2004). *The Combined Finite-Discrete Element Method*. John Wiley & Sons, Ltd.
- Bruel, D., (1995) Modelling heat extraction from forced fluid flow through stimulated fractured rock masses: evaluation of the soultz-sous-forets site potential , *Geothermics*, Volume 24, Issue 3, Pages 439-450
- Bruel, D. (2007). Using the migration of the induced seismicity as a constraint for fractured Hot Dry Rock reservoir modelling. *International Journal of Rock Mechanics and Mining Sciences*, 44, 1106–1117.
- Faivre, M, Paul B, Golfier F, Giot R, Massin P. and Colombo D. (2016) 2D coupled HM-XFEM modeling with cohesive zone model and applications to fluid-driven fracture network, *Engineering Fracture Mechanics*, 159:115-143
- Lisjak, A., Liu, Q., Zhao, Q., Mahabadi, O.K. and Grasselli, G. (2013) Numerical simulation of acoustic emission in brittle rocks by two-dimensional finite-discrete element analysis, *Geophysical Journal International*, Volume 195, Issue 1, Pages 423-443
- Pellet F. L. (2014), Rock mechanics' contribution to environmental geotechnics, *Environmental Geotechnics*, vol. 3, n°3, pp. 140
- Selvadurai, A.P.S. (2015) Normal stress-induced permeability hysteresis of a fracture in a granite cylinder, Special Issue on Crustal Permeability, *Geofluids*, 15, 37-47.





## GeoProc2017

6th International Conference on Coupled THMC Processes in Geosystems  
5-7 Jul 2017 Paris (France)

### Thermal behavior of an underground heat storage designed for large scale thermo-electric energy storage

*D. Nguyen<sup>1</sup>, E.G. Macchi<sup>2</sup>, N. Tauveron<sup>3</sup>*

*Keywords: electricity storage, granite, modeling, heat transfers*

SeleCO<sub>2</sub> research project envisages a large-scale thermo-electric energy storage concept based on a thermal doublet consisting of a “hot storage” and a “cold storage” with CO<sub>2</sub> as working fluid in transcritical Rankine cycles. The “cold storage” is latent heat based (e.g., an ice storage) while energy is stored underground in the “hot storage” in form of sensible heat. The hot storage (aka geostock) is built by setting up several hundreds of vertical co-axial geothermal heat exchangers (typically 15m long and 50cm apart) in an unfractured dry crystalline bedrock (e.g. granite). The exchangers work in both serial and parallel configuration (Figure 1). Thermal energy is transferred from/to the working fluid, circulating the closed-loop geothermal exchangers, to/from the encasing bedrock (during storage charge/discharge). Temperature in geostock is varying between 30°C and 140°C according to the charge-discharge multi-hours operating cycles. The pressure of the working fluid, in supercritical state (sCO<sub>2</sub>), reaches 120bar inside the geothermal exchangers. Implications of such non-standard parameters for a geothermal operation should be studied. Among others things, exceptional high level of turbulence ( $Re \sim 10^6$ ) of the working fluid inside the exchangers and the large size of the system require a simplified modeling approach for simulating all the heat transfers between fluid and encasing bedrock. A 1:10 exchanger prototype has also been built to better understand the heat transfers in sCO<sub>2</sub> flows. Coupled hydro-thermal process is non-relevant as the geostock must be set up in dry bedrock. In addition coupled thermo-mechanical processes are only of a second-order of importance in the operating range of the storage. On the other hand, the diffusion of heat from the geostock towards the surrounding rock needs to be carefully evaluated as it constitutes an energy loss for the storage system, and has a direct incidence on the electric storage efficiency of SeleCO<sub>2</sub> concept. Diffusive heat losses for the hot storage in its environment have been evaluated considering the geostock as a whole. For the geostock two situations are hence simulated (Table 1). Simulation A: geostock temperature is 138°C at start of diffusion with a 20°C surrounding environment; this could approach a situation of stand-by of the geostock between a charge and a discharge cycle, with no circulation of the working fluid in the geothermal exchangers; Simulation B: Succession of 4h duration charges (fluid inlet temperature in the exchangers at core: 138°C) followed by 8h discharges (fluid inlet temperature at periphery 30°C), that could represent typical

<sup>1</sup> BRGM, d.nguyen@brgm.fr

<sup>2</sup> IMFT, edoardo.macchi@imft.fr

<sup>3</sup> CEA, nicolas.tauveron@cea.fr

operating case for the geostock. Noteworthy results of both simulations are: for case A, 73% of the initial stored thermal energy (318MWh) remains in the geostock after 800h of operating stand-by (i.e., diffusive heat loss in the environment is 27%); for case B, exergy efficiency of the storage ~70% note that in some situations the environment can return energy back to the geostock (positive values in Figure 2).

Table 1. Parameters of simulations A & B

Parameter	Values	Observation
Geostock	12.3m radius - 12.3m high	Vertical cylinder
Environment	20m radius - 20m high	Zero heat transfer at boundaries
Bedrock	2650 kg/m <sup>3</sup> - 790 J/(kg·K) - 3,4 W/(m·K)	Unfractured dry granite
Simulation A	Geostock: 411K - Environment: 293K	At t=0s (Start of diffusion)
Simulation B	Geostock periphery during charge cycle: 323K Geostock periphery during discharge cycle: 303K Geostock core: 411K unchanged charge & discharge Environment: 293K	Duration of charge cycle: 4h Duration of discharge cycle: 8h Radial linear thermal zonation  At t=0s (Start of thermal cycling)

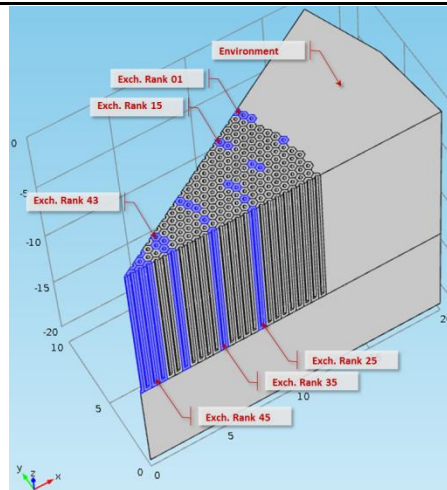

Figure 1. 30° sector of geostock showing 4 lines parallel of 45 geothermal heat exchangers serial

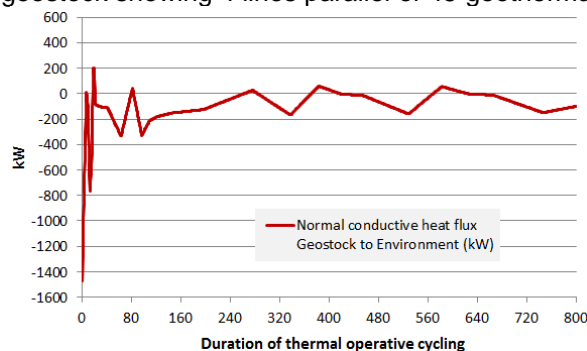

Figure 2. Simulation B: power lost from the geostock over 800h of charges-discharges

## References

- Ayachi, F. et al. (2016), Thermo-Electric Energy Storage involving CO<sub>2</sub> transcritical cycles and ground heat storage, Applied Thermal Engineering 108 (2016) 1418-1428.
- Macchi, E.G. et al. (2016), Thermoelectric energy storage based on CO<sub>2</sub> transcritical cycles: ground heat storage modelling, 1st European Seminar on Supercritical CO<sub>2</sub> (sCO<sub>2</sub>) Power Systems, September 2016, Vienna, Austria.
- Project SeleCO<sub>2</sub>, grant ANR-13-SEED-0004, partners BRGM, CEA, Enertime, ENGIE, IMFT ; project website <http://seleco2.free.fr/>



## GeoProc2017

6th International Conference on Coupled THMC Processes in Geosystems  
5-7 Jul 2017 Paris (France)

### **Modelling continental glaciation to verify the robustness of the geosphere as a barrier to radionuclide migration from a deep geological repository**

*T.S. Nguyen<sup>1</sup>, Z. Li<sup>2</sup>, M. Herod<sup>3</sup> and J. Brown<sup>4</sup>*

Canadian Nuclear Safety Commission

*Keywords: Glaciation, sedimentary, rock, geological, disposal*

Currently in Canada, both sedimentary rocks of the Michigan Basin and crystalline rocks of the Canadian Shield are being considered as potential host rock types for the deep geological disposal of radioactive wastes. The Canadian Nuclear Safety Commission (CNSC), the Canadian regulator, has carried out independent research to identify and assess key issues related to the safety of geological disposal in both types of rock. This paper summarizes our research findings to date, focussing on our understanding of the Michigan Basin sedimentary rocks and their ability to ensure the surface environment, including the Great Lakes, would be protected.

The Michigan Basin is characterized by sedimentary sequences that were deposited onto the Precambrian Shield over several episodes between ~500 – 300 million years ago. The last major tectonic event to have affected the basin occurred during the culmination of the Appalachian orogeny ~250 million years ago. During the last million years, the region has experienced nine glacial cycles, one cycle occurring roughly every 120,000 years. The last glacial cycle began ~120,000 years ago. At glacial maximum, the maximum ice thickness reached ~4 km, imposing pressures of up to 40 MPa on the lithosphere, depressing the crust by up to 500 m, while gouging and carving features, including deep valleys, into the bedrock (Fig. 1). The Great Lakes began to form ~14,000 years ago at the end of the last glacial period when glacial meltwater filled depressions left behind by glaciers. Multiple lines of evidence show that porewaters in the Ordovician host rocks at the site of a proposed deep geological repository (DGR) for low and intermediate level wastes have remained isolated from the surface waters for hundreds of millions of years:

- The porewater in the Ordovician rocks is a brine, with salinity of up to 300 g/l. This suggests that it is ancient and has remained stagnant for hundreds of millions of years.

---

<sup>1</sup> Son.nguyen@canada.ca

<sup>2</sup> Zhenze.li@canada.ca

<sup>3</sup> Matthew.herod@canada.ca

<sup>4</sup> Julie.brown@canada.ca

- Ordovician formations, including the proposed Cobourg limestone host rock and several overlying layers of shale, have remained mechanically unaffected by glaciation, and few fractures have been detected during site investigations to date.
- The Ordovician rocks are underpressured relative to hydrostatic conditions. This underpressure was likely due to depressurization after glacial retreat, and subsists to the present time because of very low rock permeability.

A mathematical model that couples mechanical, hydraulic, and chemical processes was developed to simulate the nine glacial cycles that occurred over the last million years. The model was able to confirm that Ordovician porewaters have remained unconnected to surface waters and shallow groundwaters (Fig. 2). The model was then used to assess the effect of a future glacial cycle on the proposed DGR. The model showed that the rock formations would remain resilient to such a future glaciation event and would effectively contain any radionuclide released from the DGR, ensuring long-term safety. Surface water bodies, such as the Great Lakes, would be unaffected.

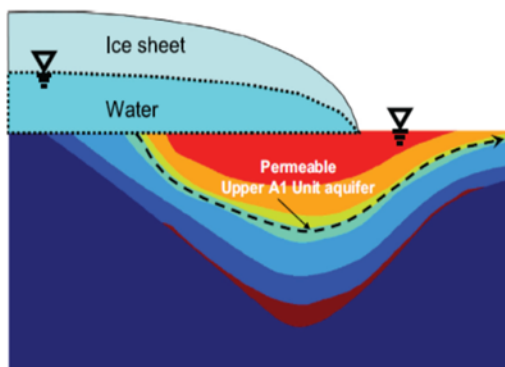

Figure 1. Illustration of continental ice sheet on the Michigan sedimentary rock basin

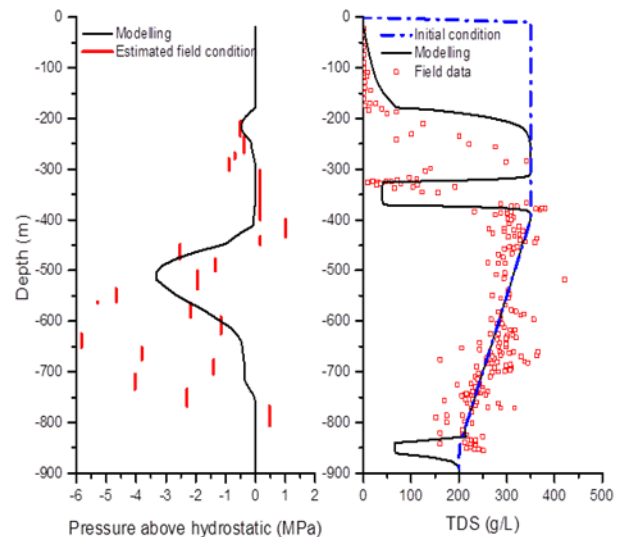

Figure 2. Present day pressure and tracer profiles – an indication of the resilience of the rock formations to nine glacial cycles.

## Reference

Nuclear Waste Management Organization, 2011. OPG's Deep Geologic Repository for Low&Intermedaite Level Waste – Geosynthesis, NWMO DGR-TR-2011-11.

Nuclear Waste Management Organization, 2011. OPG's Deep Geologic Repository for Low&Intermedaite Level Waste – Long-Term Climate Change, NWMO DGR-TR-2011-14.



## GeoProc2017

6th International Conference on Coupled THMC Processes in Geosystems  
5-7 Jul 2017 Paris (France)

### Characterization of bentonite seal infiltrated with brine from laboratory test and theoretical modelling

Z. Li<sup>1</sup>, T.S. Nguyen<sup>2</sup>, G. Su<sup>3</sup>, M. Herod<sup>4</sup>

*Keywords: bentonite, diffusive double layer, swelling, water retention curve, permeability*

Geological repositories have been considered in several countries, including Canada, as the preferred option for the disposal of radioactive wastes. In addition to the geological barrier, a major safety component of the repository system consists of engineered seal materials that include highly expansive clay minerals, such as bentonite MX-80. In Canadian sedimentary rock formations that are currently considered as one of the candidate host rock types, highly concentrated brine has been found. This concentrated brine affects the hydraulic-mechanical properties of the bentonite seal by reducing the swelling potential of the bentonite clay mineral. Therefore, it is important to further understand how the above factor influences the performance of bentonite-based seals as a barrier to radionuclide migration.

In this study, a model based on the diffusive-double-layer (DDL) theory for bentonite clay minerals was developed from the microscale and further calibrated with laboratory experimental results. The model can explain the observed dependence of swelling pressure on salt concentration and dry density, water retention curve at dilute and saturated solution, as well as the permeability dependence on dry density and salinity.

Major findings include:

- Development of a unified theoretical framework on the basis of the Poisson-Boltzmann (PB) equation and by conditioning the classic assumption of DDL upon clay-water interface, in order to model different characteristics of the bentonite seal, i.e. the swelling pressure (as shown in Fig. 1), water retention curve and permeability (as shown in Fig. 2) of expansive soil (i.e. MX-80).
- Using the same set of PB equation and the governing equation for electrokinetic flow, the permeability of compacted bentonite at various dry densities and

<sup>1</sup> Canadian Nuclear Safety Commission, zhenze.li@canada.ca

<sup>2</sup> Canadian Nuclear Safety Commission, son.nguyen@canada.ca

<sup>3</sup> Canadian Nuclear Safety Commission, grant.su@canada.ca

<sup>4</sup> Canadian Nuclear Safety Commission, matthew.herod@canada.ca

salinities were numerically evaluated and compared against the reported test data with satisfying agreement.

The above results provide better understanding on the hydro-mechanical behaviour of bentonite seals in highly saline environments.

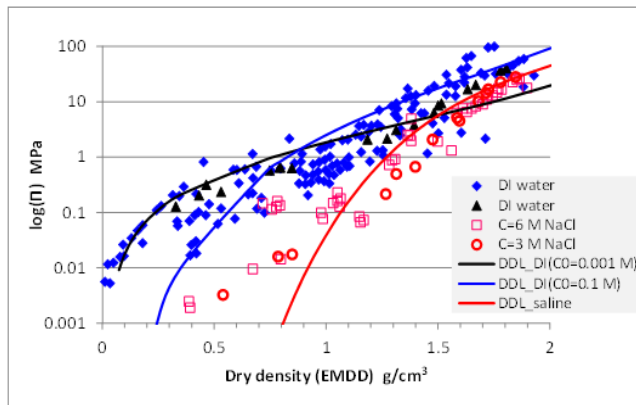

Figure 1. Swelling pressure vs effective montmorillonite dry density for MX-80 bentonite (dots are data from Man and Martino (2009) while curves are modelling results with DDL theory)

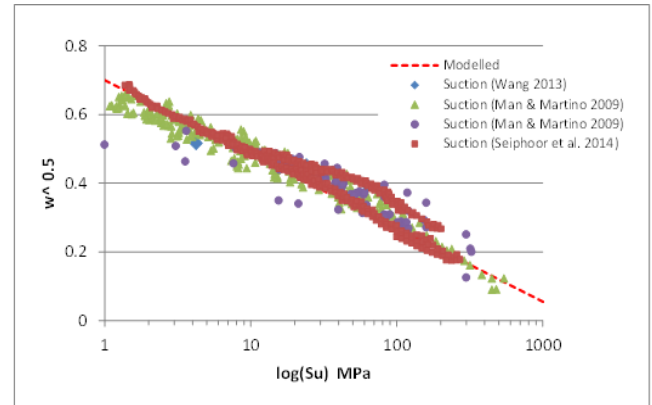

Figure 2. Linearized mass-ratio-based water retention curves for MX-80 bentonite from various sources

## Reference

Man, A. and Martino, J.B. (2009). Thermal , hydraulic and mechanical properties of sealing materials. Nuclear Waste Management Organization report NWMO TR-2009-20.



## GeoProc2017

6th International Conference on Coupled THMC Processes in Geosystems  
5-7 Jul 2017 Paris (France)

### **Modelling the desiccation induced damage zone for a bedded argillaceous rock with a visco-elastoplastic model**

*T.S. Nguyen<sup>1</sup>, Z. Li<sup>2</sup>, G. Su<sup>3</sup>, J.D. Barnichon<sup>4</sup>*

*Keywords: anisotropy, Tournemire shale, constitutive model, desiccation, EDZ*

Argillaceous rocks are candidate host and/or cap formations for the geological disposal of nuclear wastes in many countries, including Canada, France and Switzerland. The understanding of the long-term mechanical behaviour of such rocks is an essential requirement for the assessment of their performance as a barrier against radionuclide migration. Using the laboratory test data on Tournemire shale, we developed an anisotropic visco-elastoplastic constitutive model (Fig. 1) for its mechanical behaviour (Li et al. 2016).

The proposed constitutive relationship was implemented in a finite element model to simulate the shape and extent of the excavation damaged zone (EDZ) around the century-old tunnel at the Tournemire Underground Research Laboratory, from which the laboratory test samples were retrieved. Hydraulic-mechanical coupling was considered in that model. The same parameters as those determined from the laboratory tests were used as input to the model. It is found that the mechanical model alone fails to explain the observed shape and extent of the EDZ.

The tunnel was exposed to seasonal fluctuations in temperature and relative humidity, resulting in desaturation and desiccation on the walls, floor and ceiling. Therefore, the additional effect of desiccation-induced cracking has been included in the model, using an empirical relationship for suction-desiccation strain. With the above consideration, the hydro-mechanical modelling reproduced satisfactorily the observed arrow-head shaped damage zone (DDZ) above the tunnel ceiling and the layered DDZ around the tunnel's walls (Fig. 2). The fault zone that intersects the tunnel was also found to contribute to the propagation of desiccation and therefore influenced the shape of the DDZ.

Repositories for the disposal of radioactive wastes could be open during the operational period for decades or more, and could be exposed to humidity variations before being sealed and closed. Desaturation and possible desiccation of the

---

<sup>1</sup> Canadian Nuclear Safety Commission, son.nguyen@canada.ca

<sup>2</sup> Consultant, Canadian Nuclear Safety Commission, zhenze.li@canada.ca

<sup>3</sup> Canadian Nuclear Safety Commission, grant.su@canada.ca

<sup>4</sup> Institute for Radiation Protection and Nuclear Safety, JDbarnichon@irsn.fr

argillaceous rock mass around the openings should be considered in the design and safety assessment of the repositories.

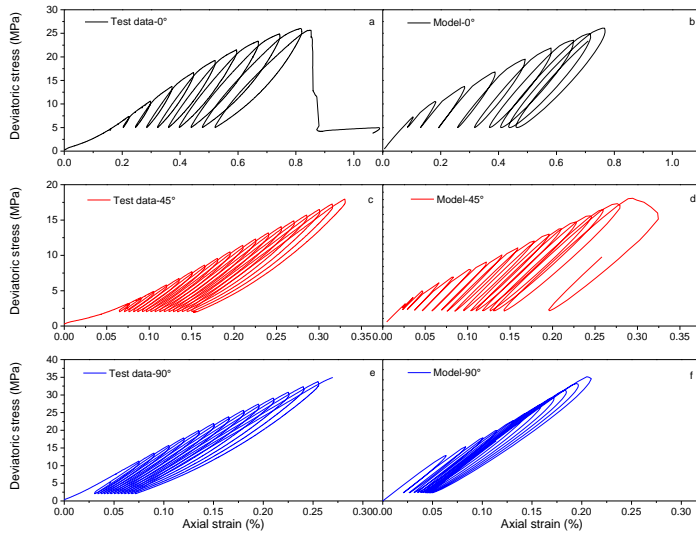

Figure 1. Unconfined stress-strain behaviour of Tournemire shale under cyclic axial loading at different bedding orientations

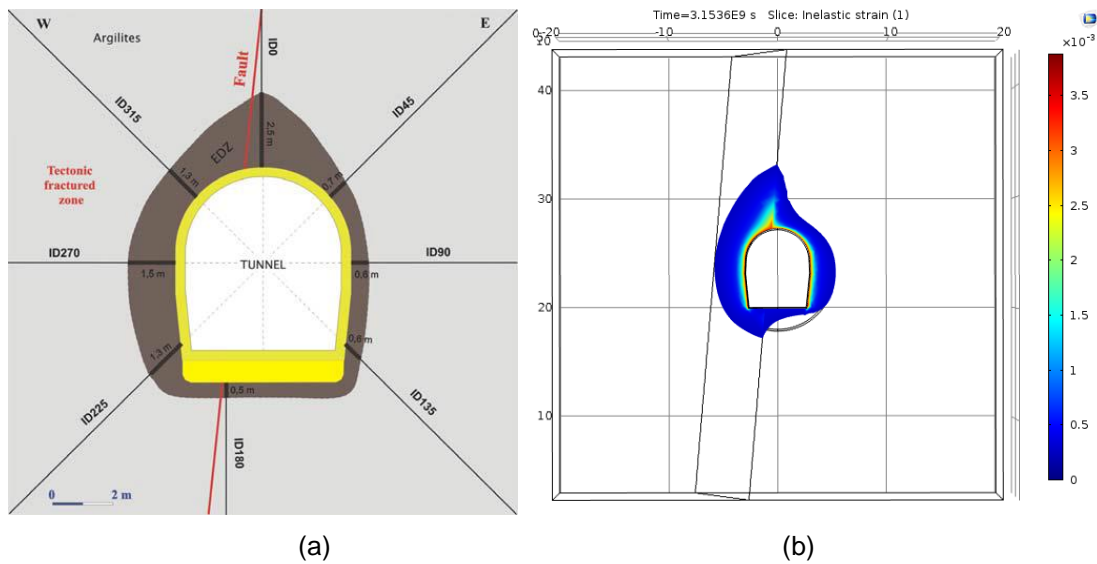

Figure 2. The extent of the EDZ around the old tunnel, near the fault (Rejeb and Stephansson, 2007) (a) and the inelastic strain (sum of plastic and desiccation strains) after 100 years of exposure since the excavation (b)

## Reference

Rejeb, A., O. Stephansson, (2007), DECOVALEX-THMC Project, Task C: Excavation damaged zone (EDZ) in argillaceous rock at Tournemire site (France). SKI Report 2007:09, ISSN 1104-1374.

Li, Z.Z., T.S. Nguyen, G. Su, D. Labrie, J.D. Barnichon (2016), Development of a viscoelastoplastic model for a bedded argillaceous rock from laboratory triaxial tests, *Canadian Geotechnical Journal*, e-first version, (doi: 10.1139/cgj-2016-0100)





## GeoProc2017

6th International Conference on Coupled THMC Processes in Geosystems  
5-7 Jul 2017 Paris (France)

### **Effect of thermal cycles on the mechanical behavior of a model energy pile in dry sand**

*V.T. Nguyen<sup>1</sup>, A. M. Tang<sup>2</sup>, J. M. Pereira<sup>3</sup>*

*Keywords: thermal cycles, mechanical behavior, scale energy pile, dry sand*

Energy piles, or heat exchanger piles, have a dual function: (i) providing support for overhead structures as a conventional pile foundation; (ii) and exchanging heat with the ground for the purpose of building heating and/or cooling. However when the pile foundation undergoes temperature changes, the mechanical response of the pile will be changed due to temperature change. In general, energy pile foundation is often designed for the lifetime of the building. Thermal exchange between the pile and surrounding soil depends on the annual energy needs of the building, heating mode in winter and cooling mode in summer. Thus energy pile foundation must undergo a heating-cooling cycle per year, and this process is repeated in the following years. In spite of various studies on the thermo-mechanical behavior of energy piles, few works have investigated their long-term behavior.

The main objective of the present study is to investigate the thermo-mechanical behavior of a small-scale model of energy pile under the thermal cycles loading. The pile model (20 mm in external diameter and 600 mm in length) was installed in dry sand. Thirty thermal cycles were applied while the pile head load was maintained at 0, 20, 40 and 60% of pile's ultimate bearing capacity. A similar pile model has been used in the works of Kalantidou et al., [2012], Yavari et al., [2014] on dry sand and Yavari et al., [2016] on saturated clay.

The long-term behavior of the pile was observed in terms of pile's head settlement and axial force profile along the pile length. The results evidenced the irreversible settlement of the pile's head induced by thermal cycles under constant load head. The incremental irreversible settlement, accumulating after each thermal cycle, decreased when the number of cycles increased and the evolution of irreversible pile head settlement versus number of cycles can be reasonably predicted by the asymptotic equation that was developed by Pasten and Santamarina, [2014] (figure 1).

---

<sup>1</sup>Hanoi University of Mining and Geology (Vietnam), triviet08@gmail.com

<sup>2</sup>Ecole des Ponts ParisTech (France), anh-minh.tang@enpc.fr

<sup>3</sup>Ecole des Ponts ParisTech (France), jean-michel.pereira@enpc.fr

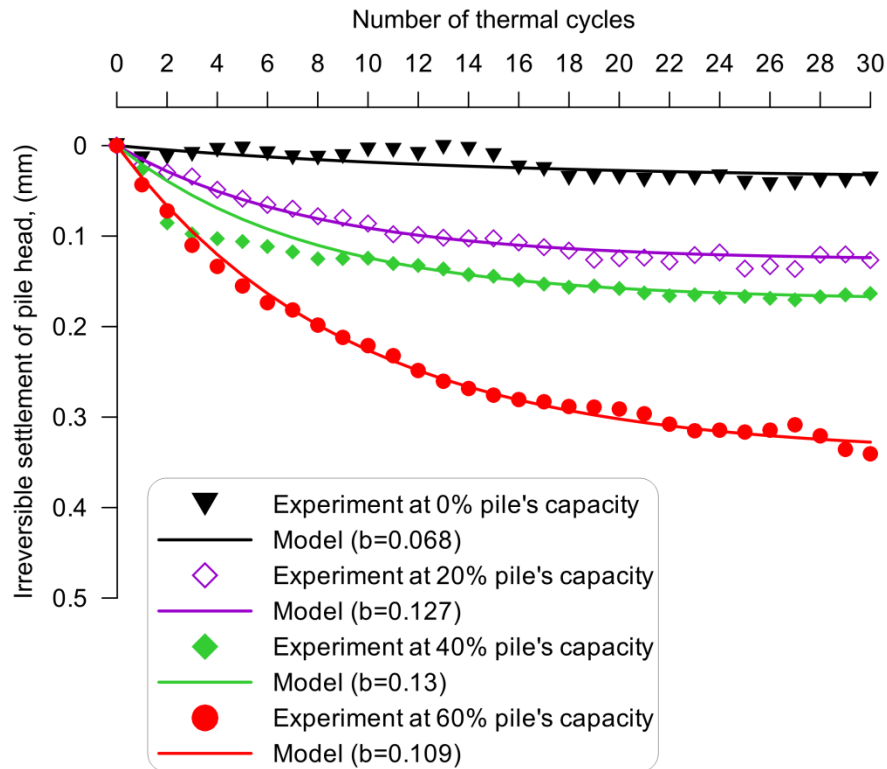

Figure 1. GeoProc2017 logo.

## References

- Kalantidou, A., A. M. Tang, J.-M. Pereira, and G. Hassen (2012), Preliminary study on the mechanical behaviour of heat exchanger pile in physical model, *Géotechnique*, 62(11), 1047–1051, doi:10.1680/geot.11.T.013.
- Pasten, C., and J. C. Santamarina (2014), Thermally Induced Long-Term Displacement of Thermoactive Piles, *J. Geotech. Geoenvironmental Eng.*, 140(5), 6014003, doi:10.1061/(ASCE)GT.1943-5606.0001092.
- Yavari, N., A. M. Tang, J.-M. Pereira, and G. Hassen (2014), Experimental study on the mechanical behaviour of a heat exchanger pile using physical modelling, *Acta Geotech.*, 9(3), 385–398, doi:10.1007/s11440-014-0310-7.
- Yavari, N., A. M. Tang, J. Pereira, and G. Hassen (2016), Mechanical behaviour of a small-scale energy pile in saturated clay, *Géotechnique*, doi:10.1680/jgeot.15.T.026.



# GeoProc2017

6th International Conference on Coupled THMC Processes in Geosystems  
5-7 Jul 2017 Paris (France)

## Coupling mechanical and swelling effects on natural stiff clays under unloading-reloading loops

X.P. Nguyen<sup>1</sup>, M. Camusso<sup>1</sup>, D. Billiaux<sup>1</sup>, Y.J. Cu<sup>2</sup>, A.M. Tang<sup>2</sup>, X.L. Li<sup>3</sup>

*Keywords: physico-chemical effect, swelling, unloading/reloading loops, FLAC*

In the framework of the Belgian deep geological radioactive waste disposal program, Boom Clay and Ypresian Clay tertiary sediments have been extensively studied for several sites (Mol, Essen, Doel, Kallo ...) and depths. In the present study, numerical simulations using a swell model in the *FLAC* software [3] have been carried out to reproduce the clay volume behaviour under unloading-reloading oedometer cycles.

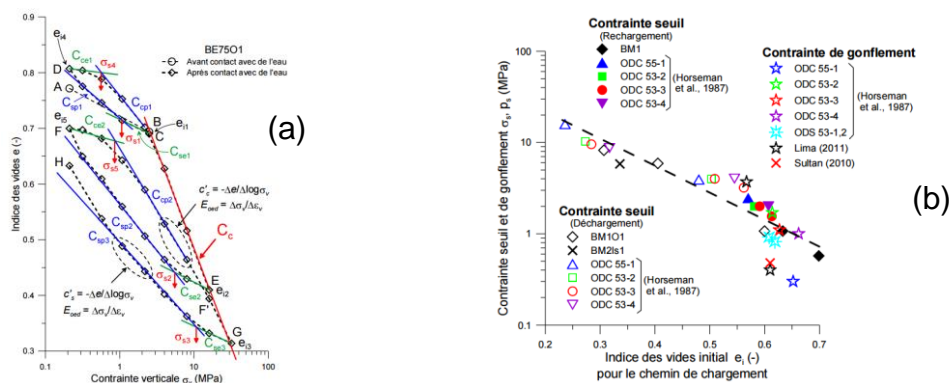

Figure 1 : Oedometer compression curve of Boom Clay at Essen (a). Swelling/threshold stress of Boom Clay at Mol (b)

Experimental results (Figure 1a) clearly exhibited a normal consolidation line characterised by a slope  $C_c$ . In addition, typical unloading/reloading hysteretic loops were also observed as in literature for sensitive fine-grained soils. Each of the unloading/reloading paths can be considered as bi-linear curve, with a change in slope for a vertical stress threshold,  $\sigma_s$ . From a microstructural-variation point-of-view this threshold stress can be seen as the swelling pressure corresponding to the void ratio before the specimen undergoes the unloading or reloading path (Figure 1b).

Indeed, during unloading, negligible microstructural changes occur when the applied stress is above  $\sigma_s$  (elastic unloading). Once the stress is reduced below  $\sigma_s$ , physico-chemical effects become prevailing, and soil swelling occurs with a larger microstructure change. Similarly, upon reloading, when the applied stress is below  $\sigma_s$ ,

<sup>1</sup> ITASCA Consultants S.A.S., [x.nguyen@itasca.fr](mailto:x.nguyen@itasca.fr), [m.camusso@itasca.fr](mailto:m.camusso@itasca.fr), [d.billiaux@itasca.fr](mailto:d.billiaux@itasca.fr)

<sup>2</sup> Ecole des Ponts ParisTech, Laboratoire Navier/CERMES, [yu-jun.cui@enpc.fr](mailto:yu-jun.cui@enpc.fr), [anhminh.tang@enpc.fr](mailto:anhminh.tang@enpc.fr)

<sup>3</sup> Euridice Group, c/o SCK/CEN, [xiang.ling.li@euridice.be](mailto:xiang.ling.li@euridice.be)

the microstructure is not significantly affected thanks to the clayey matrix suction. Above  $\sigma_s$ , the mechanical effects become dominant, producing larger volume change associated with microstructure collapse. Further loading beyond the pre-consolidation stress  $\sigma_p$  produces higher volume change due to plastic straining [1].

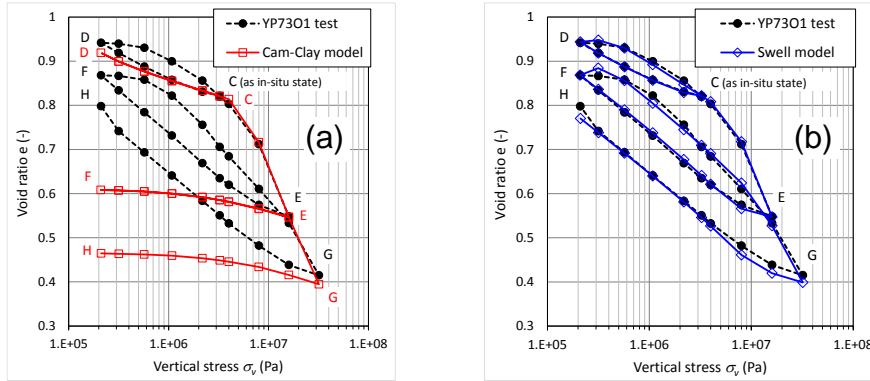

Figure 2 : Oedometer compression curve of Ypresian Clays: experiments vs simulations with Cam-Clay (a) and swell (b) models

The stress-dependent mechanical and physico-chemical features cannot be simulated by common elasto-plastic models such as the Cam-Clay [2] (Figure 2a), which only allows to reproduce the normal consolidation line and the first part of the unloading paths.

However, this limitation can be overcome by introducing swelling/collapse strain components to the elastic strains calculated by the model [3]:

$$\Delta \varepsilon^s_{y'y'} = c_1 \text{Log} \frac{-\sigma_{y'y'}}{\sigma_s} ; \quad \Delta \varepsilon^s_{x'x'} = \Delta \varepsilon^s_{z'z'} = c_3 \text{Log} \frac{-\sigma_{y'y'}}{\sigma_s} \quad (1)$$

where  $x'$  and  $y'$  are the principal swelling directions. The corresponding swelling/compression stress increments are then computed by Hooke's law:

$$\Delta \sigma^s_{y'y'} = -[(K + 4/3G)\Delta \varepsilon^s_{y'y'} + (K - 2/3G)(\Delta \varepsilon^s_{x'x'} + \Delta \varepsilon^s_{z'z'})] \quad (2)$$

and similarly for  $\Delta \sigma^s_{x'x'}$  and  $\Delta \sigma^s_{z'z'}$ . Figure 2b shows that the unloading-reloading volume changes of Ypresian Clays are satisfactorily predicted by the implemented swell model. Further extensions of the model to reproduce deviatoric behaviour and clay anisotropy may be possible through the parameter  $c_3$  and/or by involving other stress component in equation (1).

## References

- [1] Cui YJ, Nguyen XP, Tang AM, Li XL (2013), An insight into the unloading/reloading loops on the compression curve of natural stiff clays. *App. Clay Sc.*, 83–84, 343-348.
- [2] Schofield A, Wroth P. (1968), *Critical state soil mechanics*. McGraw-Hill.
- [3] ITASCA (2016), *FLAC V8. Fast Lagrangian Analysis of Continua. Constitutive Models*.



## GeoProc2017

6th International Conference on Coupled THMC Processes in Geosystems  
5-7 Jul 2017 Paris (France)

### Earthquake rupture modeling on complex fault systems and complex media

*K. Okubo<sup>1,2</sup>, H. S. Bhat<sup>2</sup>, Y. Klinger<sup>3</sup>, E. Rougier<sup>4</sup>*

*Keywords: Earthquake rupture modeling, Off-fault damage, Combined finite-discrete element method*

Earthquake rupture modeling has been developed for understanding seismic source mechanism and its radiation and producing scenarios of earthquake events based on proper constitutive law and friction law. Complexities of earthquake ruptures contain a wide range of length scale; complex fault geometry such as fault branches and kinks is on kilometeric scale, while coseismic off-fault damage would be regarded to be on metric scale. Therefore, the earthquake rupture modeling should be conducted rectifying these complexities, which has the different length scale from metric to kilometeric.

Previous studies have shown a part of this problem with various numerical techniques. *Aochi and Fukuyama* [2002] applied boundary integral equation method (BIEM) for earthquake rupture modeling on complex fault geometry and it shows slip distribution on the fault and geophysical information such as stress drop. Recently, *Thomas et al.* [2016] applied spectral element method (SEM) for earthquake rupture modeling with coseismic off-fault damage. They adopted a modified constitutive law by damage mechanics to homogenize the effect of coseismic off-fault damage and found that high-frequency radiation is enhanced by the coseismic off-fault damage.

Although state of the art techniques can partially deal with those complexities, they should be ideally included simultaneously in the earthquake rupture modeling to reveal complex interactions and obtain realistic estimations of geophysical information. In this study, we propose a new scheme for the earthquake rupture modeling, combined finite-discrete element method (FDEM). It has been developed originally by *Munjiza* [2004] and applied for problems on modeling of fracturing in the past decade [e.g., *Rougier et al.*, 2011]. The FDEM-based software tool used for this analysis is called HOSSedu (Hybrid Optimization Software Suite – Educational Version), which was developed by Los Alamos National Laboratory. We applied this method for the earthquake rupture modeling to deal with dynamically generated coseismic off-fault damage by extending it with slip-weakening friction law and appropriate fracture nucleation and growth criteria.

<sup>1</sup> Institut de Physique du Globe de Paris, Paris, France, okubo@ipgp.fr

<sup>2</sup> École Normale Supérieure, Paris, France, bhat@geologie.ens.fr

<sup>3</sup> Institut de Physique du Globe de Paris, Paris, France, klinger@ipgp.fr

<sup>4</sup> Los Alamos National Laboratory, Los Alamos, NM, USA, erougier@lanl.gov

Our result shows coseismic off-fault damage following rupture front shown in Figure 1 (a). The cracks appear more on extensional side (bottom half), which has good agreement with experimental results [Ngo *et al.*, 2012] and theoretical analysis [Rice *et al.*, 2005]. The high-frequency radiation is enhanced by the coseismic off-fault damage shown in Figure 1 (b).

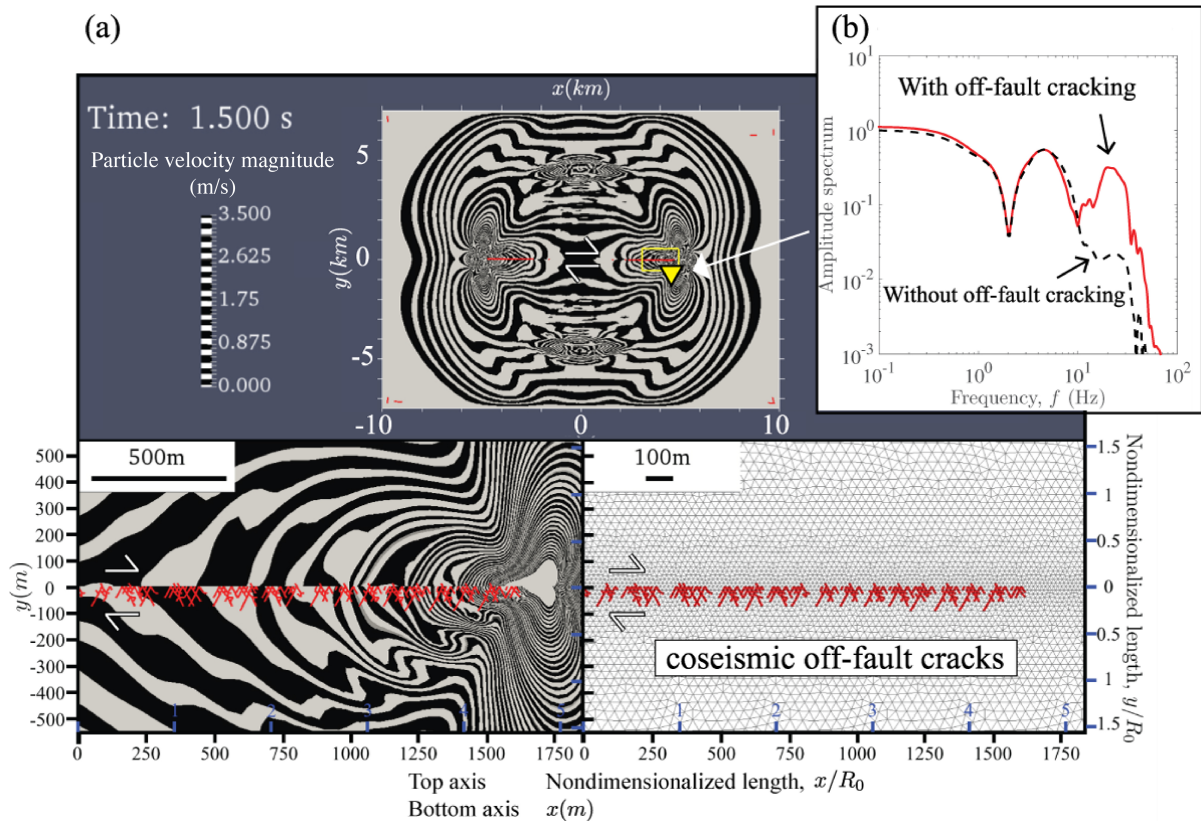

Figure 1. (a) Snapshot of earthquake rupture modeling with coseismic off-fault damage. Pseudo color contour shows particle velocity magnitude and red line shows dynamically generated coseismic off-fault cracks. Axes of bottom windows show actual size and nondimensionalized length,  $x/R_0$ , where  $R_0$  is estimated process zone size with linear slip-weakening law. (b) Comparison of amplitude spectrum of acceleration with/without off-fault damage.

## References

- Aochi, H., and E. Fukuyama (2002), Three-dimensional nonplanar simulation of the 1992 landers earthquake, *J. Geophys. Res.*, *107* (B2), doi:10.1029/2000JB000061.
- Munjiza, A. (2004), The Combined Finite-Discrete Element Method, *Wiley Online Library*, doi:10.1002/0470020180.
- Ngo, D., Y. Huang, A. J. Rosakis, W. A. Griffith, and D. D. Pollard (2012), Off-fault tensile cracks: A link between geological fault observations, lab experiments, and dynamic rupture models, *J. Geophys. Res.*, *117*(B01), doi:10.1029/2011JB008577.
- Rice, J. R., C. G. Sammis, and R. Parsons (2005), Off-fault secondary failure induced by a dynamic slip pulse, *Bull. Seism. Soc. Am.*, *95* (1), 109–134, doi:10.1785/0120030166.
- Rougier, E., E. Knight, A. Sussman, R. Swift, C. Bradley, A. Munjiza, S. Broome, et al. (2011), The combined finite-discrete element method applied to the study of rock fracturing behavior in 3d, in *45th US Rock Mechanics/Geomechanics Symposium*, American Rock Mechanics Association.
- Thomas, M. Y., H. S. Bhat, and Y. Klinger (2016), Dynamic off-fault damage and seismic radiation, in *Fault Zone Properties and Processes during Dynamic Rupture*, vol. accepted, edited by M. Y. Thomas, H. S. Bhat, and T. M. Mitchell, AGU Monographs.



## GeoProc2017

6th International Conference on Coupled THMC Processes in Geosystems  
5-7 Jul 2017 Paris (France)

### The effects of temperature on oil wellbore stability in rocks using coupled THM numerical simulation

*M. Oliaei<sup>1</sup>, S.M. Ghazi Mirsaeed<sup>2</sup>, M. Torkaman<sup>3</sup>*

*Keywords: coupled THM, thermal effects, wellbore stability, yielding surface*

In the past decades, the oil companies and wellbore owners asked contractors to reduce time-and thereby the cost- of drilling oil wells. Also, as about 10% of the drilling cost is being spent to deal with wellbore instability, the wellbore stability analysis should be investigated thoroughly. In recent years, different conditions and types of oil well instability have been analyzed; however, coupled thermo-hydro-mechanical analyses are usually neglected due to complexity of governing equations.

In this research, firstly, thermal effects on stresses were investigated by comparing HM and THM models using finite element method (FEM) in Abaqus 6.14 software (Figure 1).

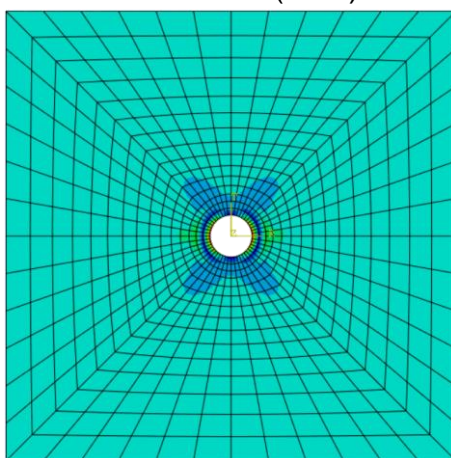

Figure 1. Stresses around wellbore after THM analysis

The constitutive model was elastic perfect plastic and, Mohr-Coulomb failure criterion was employed. The input data were obtained from a section at the depth of 1589 meters of a North Sea exploration well [1]. The maximum temperature of mud during drilling was considered 150°C and the temperature of formation at this depth is 100°C.

After comparison between HM and THM models, in the second step, the effects of temperature variations on the cohesion ( $c$ ) and friction angle ( $\phi$ ) parameters of the rock were investigated in order to determination of the temperature effects on yielding

<sup>1</sup> Assistant Professor at Tarbiat Modares University, Iran, Tehran

<sup>2</sup> Ms. Student at Tarbiat Modares University, Tehran, Iran

<sup>3</sup> Visitor at Tarbiat Modares University, Tehran, Iran

surface. For this purpose, data were obtained from some triaxial tests carried out at 20, 100, 150, 200°C temperatures [2]. (Figure 2)

The results showed that the increase in temperature causes the stresses to increase (Figure 3). Moreover, the friction angle ( $\phi$ ) and cohesion ( $c$ ) of the rock and consequently yield strength decreased as the temperature increased (Figures 4,5). As a result, the instability potential was enhanced in both cases. To sum up, the temperature increased instability twice by surge in stress and drop in strength.

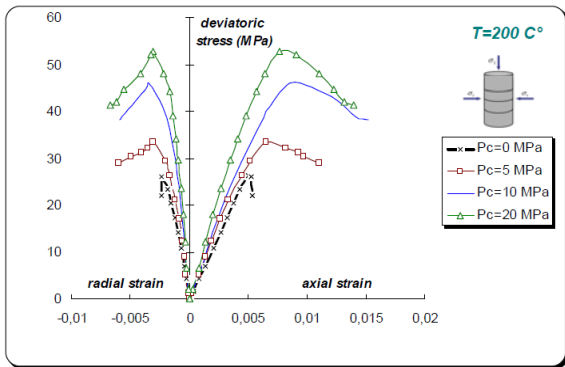

Figure 2. A set of triaxial test results carried out at 200°C [2]

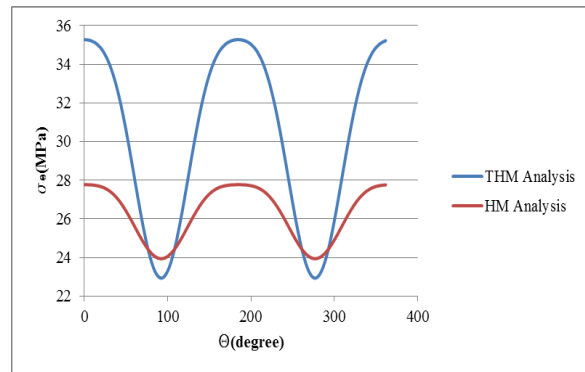

Figure 3. The effects of temperature on the stresses analysis results

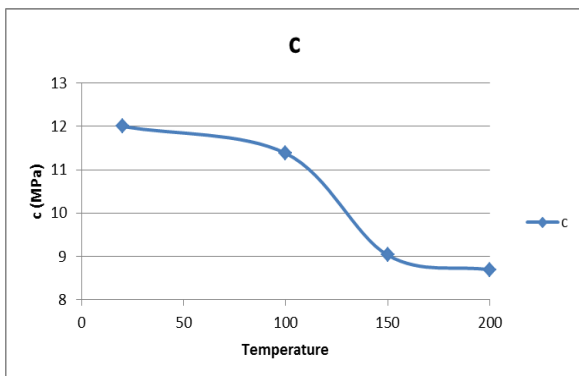

Figure 4. The decrease rate of rock cohesion ( $c$ )

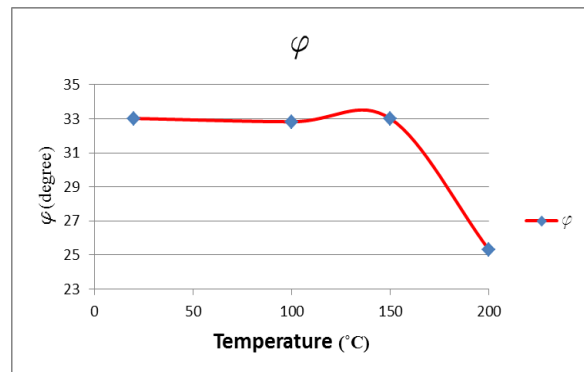

Figure 5. The decrease rate of rock friction angle ( $\phi$ )

## References

[1] Prazeres, I. (2015), Wellbore Stability and the Thermal Effects Analysis for a North Sea Exploration Well, M.S. thesis, Department of Petroleum Engineering and Applied Geophysics, Norwegian University of Science and Technology, Trondheim, Norway.

[2] Masri, M., Sibai, M., & Shao, J. F., 2008, October, Experimental Study of the Thermomechanical Behavior of the Petroleum Reservoir, paper presented at SPE Eastern Regional/AAPG Eastern Section Joint Meeting, Society of Petroleum Engineers, Pittsburgh, Pennsylvania, USA





## GeoProc2017

6th International Conference on Coupled THMC Processes in Geosystems  
5-7 Jul 2017 Paris (France)

### Experimental characterization of desiccation of lime treated clayey silt

*N. Poncelet<sup>1</sup>, B. François<sup>2</sup>*

*Keywords: desiccation, unsaturated effective stress, lime-treatment, shrinkage*

Lime treatment is commonly used in civil engineering to improve soil mechanical properties. It is demonstrated since decades that stiffness and strength of clayey soils are drastically increased by the addition of a few percent of lime while the swelling potential is significantly reduced (Guney et al. 2008). However, the behaviour of lime-treated soils upon wetting/drying cycles is still under debate. The use of lime-treatment technique for hydraulic works, such as earth dams or dikes, is narrowed because of those uncertainties on the effects of the moisture evolution on the soil behaviour.

The present work investigates the desiccation effects on a lime-treated clayey silt used in the construction of a prototype dike. The objective is to identify the conditions that could generate desiccation cracking and identify the role of lime treatment in their mitigation. First of all, the samples are reconstituted by a compaction at a water content 2% wetter than the optimum normal proctor condition. Then, the wetting and/or drying processes of lime-treated soil samples are imposed through two complementary techniques: the osmotic method for suction lower than 10 MPa and the saline solutions technique for higher suctions.

Multiple tests are carried out to determine hydro-mechanical properties of the natural and lime-treated soils: water retention tests, unconfined compression tests and indirect tensile tests at different suction levels and free and constrained drying to evaluate the shrinkage potential (for free drying) and the conditions of desiccation crack triggering (upon constrained drying). A 3D scanner (Figure 1) is used to precisely determine the time evolution of the crack network, and the global shrinkage.

- At the end, generalized effective stress framework (Nuth and Laloui, 2008) is used to provide a constitutive interpretation of the occurrence of desiccation cracks in relation with the water retention properties, the soil stiffness, the tensile strength and the geometrical constraints of the soil samples. The role of lime treatment on the mitigation of desiccation cracking is discussed.

<sup>1</sup> Université Libre de Bruxelles, nponcele@ulb.ac.be

<sup>2</sup> Université Libre de Bruxelles, bertrand.francois@ulb.ac.be

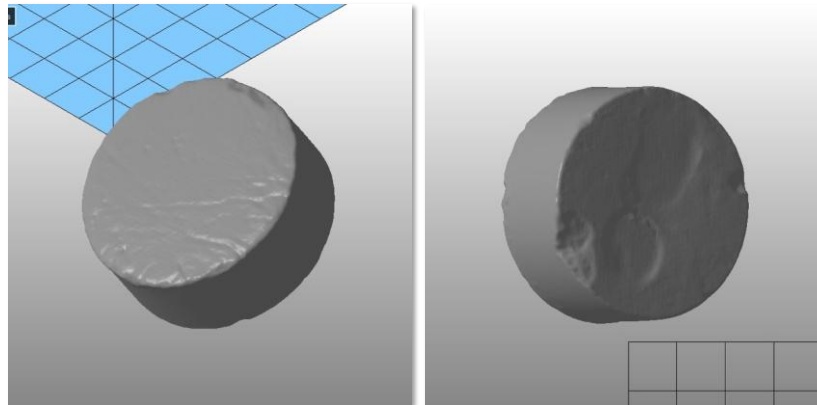

Figure 1. Soil sample shape obtained by the 3D scanner.

## References

- Guney, Y., Sari, D., Cetin, M., & Tuncan, M. (2007). Impact of cyclic wetting–drying on swelling behavior of lime-stabilized soil. *Building and Environment*, 42(2), 681-688.
- Nuth M., Laloui L. (2008). Effective stress concept in unsaturated soils: clarification and validation of a unified framework. *International Journal of Numerical and Analytical Methods in Geomechanics*; 32(7), 771-801.



## GeoProc2017

6th International Conference on Coupled THMC Processes in Geosystems  
5-7 Jul 2017 Paris (France)

### **Hydraulic – natural fracture interactions and stress field perturbation, insights from a coupled 3D discrete element model**

*E. Papachristos<sup>1</sup>, L. Scholtès<sup>2</sup>, FV. Donzé<sup>3</sup>, B. Chareyre<sup>4</sup>*

*Keywords: hydraulic fracture, stress field perturbation, natural fractures, fault zone activation*

Pre-existing fracture networks or large scale single natural discontinuities (i.e., large bedding planes, vertical joints or fault zones) are ubiquitous in shale-plays. However, the factors driving the interaction between hydraulic fractures and pre-existing defects remain yet to be clarified. In this work a three-dimensional hydro-mechanically coupled discrete element method (Papachristos et al., 2016, 2017) is used to investigate how a propagating hydraulic fracture can interact with a single pre-existing defect.

During the numerical simulations, the recording of both the spatio-temporal evolution of the cracking events and of the pressure field enables to follow the evolution of the hydraulic fracture in the medium [Figure 1]. In addition, the deformation as well as the local stress field magnitude and orientation are studied in an attempt to discriminate the nature of the interaction taking place between the hydraulic fracture and the pre-existing defect. This interaction can be classified according to different criteria available in the literature determining if the hydraulic fracture crosses the defect or if it induces dilation or shearing of the latter (Warpinsky et al., 1987, Liu et al., 2015).

An extensive sensitivity analysis is performed in order to assess the role of the differential boundary stress applied ( $\sigma_1 - \sigma_3$ ), approach angle, friction and dilation angles, stiffness ratio between rock matrix and natural fractures and fluid viscosity during the interaction process. The effect of each parameter is analyzed and discussed separately. We show that the numerical results agree well with the analysis given by [4] (Figure 2).

---

<sup>1</sup> Univ. Grenoble Alpes, 3SR, CS 40700, F-38058, Grenoble Cedex 9, France, [efthymios.papachristos@3sr-grenoble.fr](mailto:efthymios.papachristos@3sr-grenoble.fr)

<sup>2</sup> Univ. de Lorraine & CNRS & CREGU, Laboratoire GeoRessources, Nancy, France, [luc.scholtes@univ-lorraine.fr](mailto:luc.scholtes@univ-lorraine.fr)

<sup>3</sup> Univ. Grenoble Alpes, 3SR, CS 40700, F-38058, Grenoble Cedex 9, France, [frederic.donze@3sr-grenoble.fr](mailto:frederic.donze@3sr-grenoble.fr)

<sup>4</sup> Univ. Grenoble Alpes, 3SR, CS 40700, F-38058, Grenoble Cedex 9, France, [bruno.chareyre@3sr-grenoble.fr](mailto:bruno.chareyre@3sr-grenoble.fr)

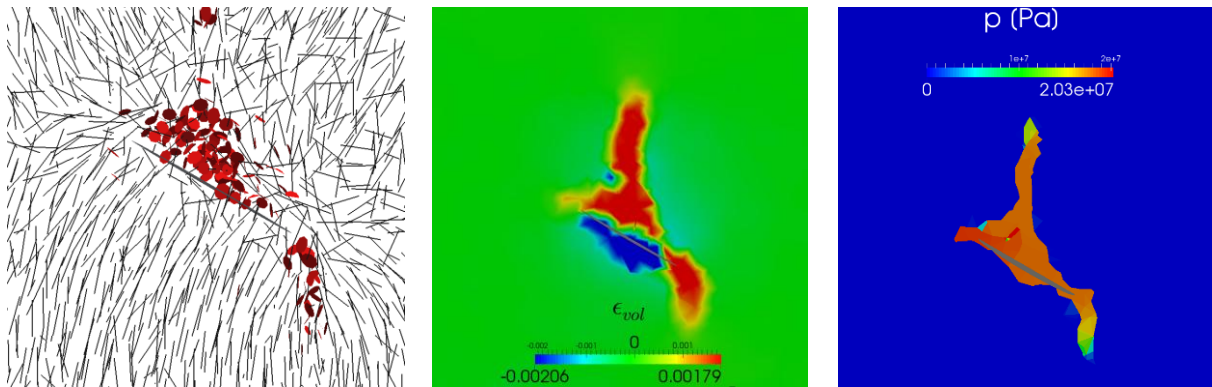

Figure 1. (Left) Local maximum principal stress ( $\sigma_1$ ) direction and micro crack events, (Centre) volumetric strain field  $\epsilon_{vol}$  and (Right) pressure field around a compliant natural fracture during the intersection with a hydraulic fracture.

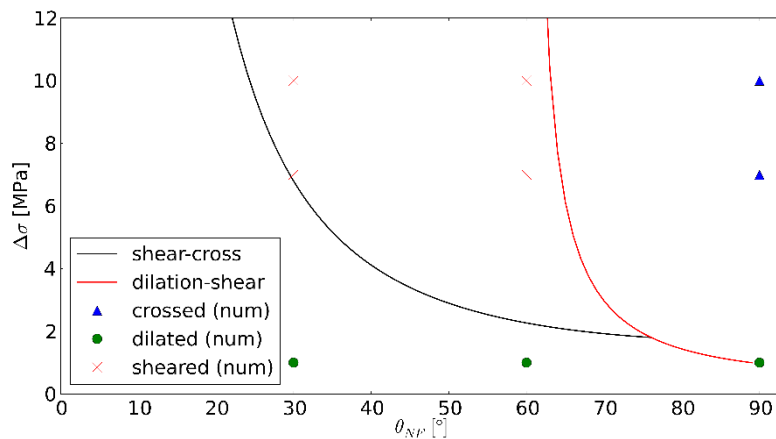

Figure 2. Comparison of numerical results to the analysis of [4] for different approach angles ( $\theta_{NF}$ ) and differential stresses ( $\Delta\sigma$ ) applied.

## References

- Papachristos, E., and Scholtès, L., and Donzé FV., Chareyre, B., and Pourpak, H. (2016), 3D hydro-mechanical modeling of multiple injections, 50<sup>th</sup> US Rock Mechanics/Geomechanics Symposium, American Rock Mechanics Association.
- Papachristos, E., and Scholtès, L., and Donzé FV., and Chareyre, B. (2017), Intensity and volumetric characterizations of hydraulically driven fractures by hydro-mechanical simulations, International Journal of Rock Mechanics and Mining Sciences.
- Warpinski, N. R., & Teufel, L. W. (1987). Influence of geologic discontinuities on hydraulic fracture propagation (includes associated papers 17011 and 17074). Journal of Petroleum Technology, 39(02), 209-220.
- Liu, Y., Xiu, N., Ding, Y., Wang, X., Lu, Y., Dou, J., Yan, Y., and Liang, T. (2015). Analysis of multi-factor coupling effect on hydraulic fracture network in shale reservoirs. Natural Gas Industry B, 2(2), 162-166.



## GeoProc2017

6th International Conference on Coupled THMC Processes in Geosystems  
5-7 Jul 2017 Paris (France)

### Pore and grain scale changes during pore collapse and liquefaction in chalk

*E Papamichos<sup>1,2</sup>, LE Walle<sup>2</sup>*

*Keywords: Chalk, pore collapse, liquefaction, pore scale*

Hollow cylinder (HC) tests with radial fluid flow towards the hole are typical tests in studying borehole stability and failure in reservoir rocks during hydrocarbon production. In such tests in Mons chalk, a high porosity chalk analogue of North Sea fields, pore collapse (PC) and/or Liquefaction Failure (LF) are possible and may lead to sudden chalk influx. The identification of locations of PC and LF is important in order to elucidate the effect of PC in the observed chalk influx. First Scanning Electron Microscope (SEM) analysis was used to visually study changes in the grain and pore structure and cementation. SEM analysis was able to identify a smaller number of intact coccoliths in the tested samples but not a clear distinction as to the type of failure. Therefore, Mercury Porosimetry (MP) was employed and proven successful. The liquefaction failure area is considered here to be the area adjacent to the catastrophic failure zone observed in hollow cylinder (HC) type tests, as shown in Figure 1.

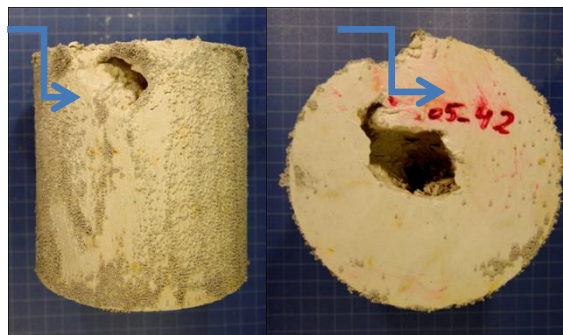

Figure 1. Typical liquefaction type failure on hollow cylinder on brine saturated Mons chalk. Arrows indicate the location of the failure area.

Three Mons specimens were tested. At each specimen twin samples were taken to check the variability and homogeneity of the pore structure which proved to be relative small. The samples were obtained from the following specimens and locations: (a) Virgin Mons, (b) Hydrostatic test on oil saturated specimen with pore collapse (Figure

<sup>1</sup>AristotleUniversityof Thessaloniki, Greece, [epapamic@civil.auth.gr](mailto:epapamic@civil.auth.gr)

<sup>2</sup>SINTEF Petroleum Research, Trondheim, Norway, [euripides.papamichos@sintef.no](mailto:euripides.papamichos@sintef.no)

2\_left), and (c) From liquefaction zone of a HC depletion type test on a brine saturated specimen(Figure 2\_right).

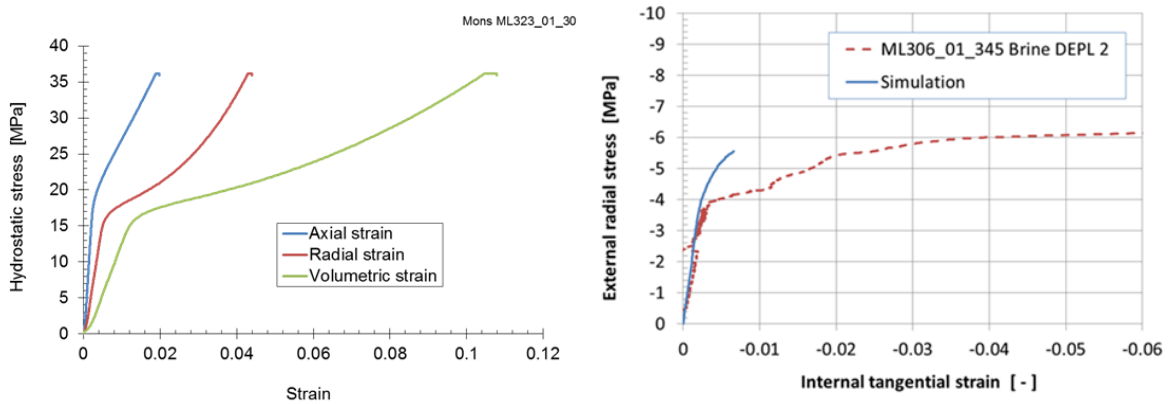

Figure 2. Hydrostatic test stress strain curve showing pore collapse at ca. 16 MPa (left) and HC depletion test externals stress vs normalized with internal radius cavity closure (right).

As presented in Figure 3, mercury porosimetry analysis led to the following conclusions with respect to the pore structure during pore collapse and liquefaction where  $k_0$  is the permeability of virgin Mons:

- Pore collapse leads to (i) reduction in porosity, (ii) reduction in pore area, (iii) no significant change in mean pore diameter, (iv) both largest and smallest pores are reduced, (v) reduction in permeability  $k$ .
- Liquefaction leads to (i) some reduction in porosity, (ii) no significant reduction in pore area, (iii) larger pores become smaller, (iv) reduction of average pore diameter, i.e. shift to the left in pore size distribution, and (v) reduction in permeability  $k$ .

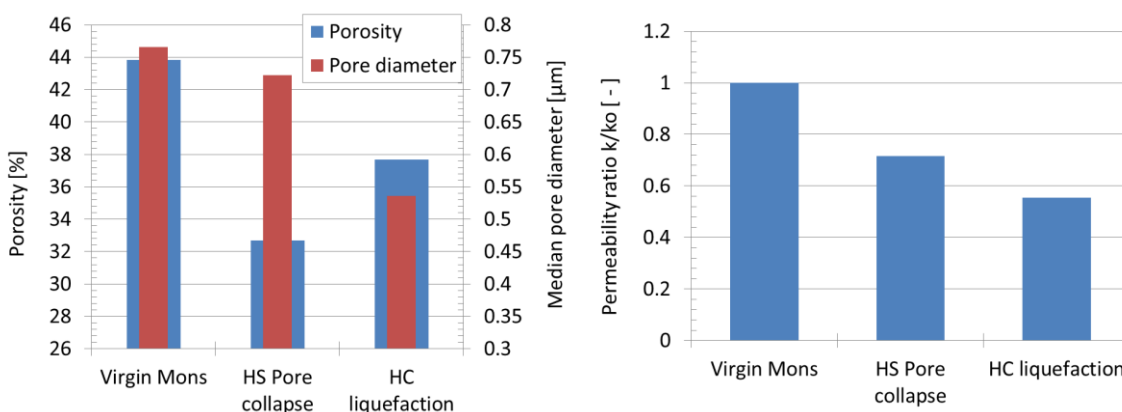

Figure 3. Mercury porosimetry results for virgin Mons, pore collapsed Mons under hydrostatic compression and liquefied Mons during HC testing. Porosity and median pore diameter (left) and permeability (right).



## GeoProc2017

6th International Conference on Coupled THMC Processes in Geosystems  
5-7 Jul 2017 Paris (France)

### Crack-tip plastic deformation in fluid-saturated solids

*Panos Papanastasiou*<sup>1</sup>

*Keywords:* crack-tip, singular plastic fields, elastoplastic, non-associative material.

The near tip processes of a propagating hydraulic fracture influences the propagation pressure and the fracture dimensions. These processes include the viscous flow in the fracture and the formation of a dry zone (fluid-lag), the cohesive zone and the wider area dominated by shear plastic deformation called here a process zone. These mechanisms are coupled and interact with each other eliminating the relative importance of one mechanism or may result in an elevated effective fracture toughness at the macroscopic level.

One of the mechanisms that so far has not been studied is the shear stresses that are transferred by the viscous fluid on the crack surfaces near the tip (Wrobel et al, 2017). In order to assess the role of the shear stresses we study its influence on the stress singular behaviour near a tip of a fracture (Papanastasiou and Durban, 2001) or a wedge (Papanastasiou et al, 2003) embedded in a Drucker-Prager power law hardening material. We carried out an asymptotic analysis for determining the stress and pore pressure fields near the tip of a crack that propagates under quasi-static, plane strain and Mode I loading conditions in a saturated solid (Radi et al, 2002). The coupling of porous fluid-flow and skeleton solid deformation is done through the Biot effective stress definition. The crack propagates in an elastoplastic fluid-saturated Drucker-Prager solid with a power law hardening and non-associative dilatant behavior. Both conditions of permeable and impermeable crack faces are examined.

The level of singularity and the corresponding singular field for the stress, strain, displacement and pore pressure are determined. The sensitivity of these quantities to the level of hardening, friction and degree on non-associativity is illustrated for representative cases. We found that the shear stresses decreases the lever of singularity which increases more the importance of the plastic region, as well the formation of plastic area near the crack faces that may influence its roughness. As an example, Figure 1 shows a comparison of the stress singularity ( $s$ ) at the tip of a wedge indentation in a power-law hardening ( $n=3$ ), pressure sensitive plastic material ( $\mu=0, 0.5$ ) for normal crack loading ( $m=0$ ) and shear stress loading ( $m=0.5$ ). The singularity decreases when shear stresses are applied at the crack surfaces resulting in increase of the area near the

---

<sup>1</sup> University of Cyprus, 1678 Nicosia, Cyprus, panospap@ucy.ac.cy

crack-tip that yields. Finally the relation between the level of singularity and increase in the effective fracture toughness is examined

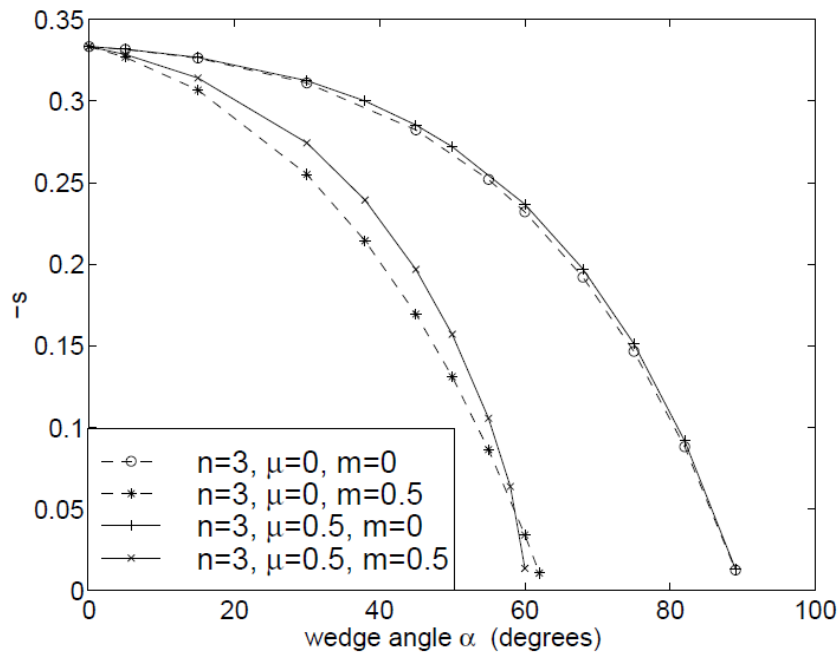

Figure 1. Comparison of the stress singularity ( $s$ ) at the tip of a wedge indentation in a power-law hardening ( $n=3$ ), pressure sensitive plastic material ( $\mu=0, 0.5$ ) for normal crack loading ( $m=0$ ) and shear stress loading ( $m=0.5$ ).

## References

- Papanastasiou, P. and D. Durban, (2001). Singular plastic fields in non-associative pressure sensitive solids. *Int. J. Solids and Struct.* 38, 1539-1550.
- Papanastasiou P, Durban D and Lenoach B (2003). Singular plastic fields in wedge indentation in non-associative, pressure-sensitive solids. *Int. J. Solids Struct.* 40, pp.2521-2534.
- Radi, E., Bigoni, D. and B. Loret (2002). Steady crack growth in elastic-plastic fluid-saturated porous media, *Int. J. Plasticity*, 18, 345-358.
- Wrobel M., Mishuris G. and Piccolroaz A. (2017). Energy Release Rate in hydraulic fracture: can we neglect an impact of the hydraulically induced shear stress? *Int. J. Eng. Sc.* (in press)





## GeoProc2017

6th International Conference on Coupled THMC Processes in Geosystems  
5-7 Jul 2017 Paris (France)

### **Boudinage and folding as the same fundamental energy instability in ductile deformation**

*M. Peters*<sup>1</sup>, *T. Poulet*<sup>2</sup>, *K. Regenauer-Lieb*<sup>3</sup>, *M. Veveakis*<sup>2,3</sup>

Keywords: *Boudinage and folding theory, Thermo-mechanical feedbacks, Layered materials, Shear heating, Numerical methods*

In classic mechanics, folding and boudinage are regarded as a geometric problem. This means that an initial infinitesimal small imperfection amplitude grows, which ultimately leads to localization through a process known as wavelength selection. One drawback of this approach using a linearized material response is that folding and boudinage develop for different material parameters or power-law exponents. In the past, this complication has led to a discussion about the applicability of such approaches to localized structures in real rocks (Hobbs et al., 2010 and references therein). Here, we are concerned with a more generic localization theory, i.e. strain localization out of steady-state conditions inside a homogeneous material at a critical material parameter and deformation rate (e.g. Regenauer-Lieb and Yuen, 2003; Peters et al., 2015). In this framework considering energy flows and microphysical processes, instability arises out of the constitutive description itself for a critical amount of shear heating and layer thickness (Gruntfest, 1963). The implementation of the coupled thermo-mechanical 2-D finite element model comprises an elastic and rate-dependent *von Mises* plastic rheology (Peters et al., 2016). The underlying system of equations is solved in a 3-layer pure shear box for constant velocity and isothermal boundary conditions, using the open-source finite element software *REDBACK* (Poulet et al., 2016). In order to examine the transition from stable to localized creep, we study how material instabilities are related to energy bifurcations, which arise independently of the sign of the stress conditions imposed on the boundaries, whether in compression or extension. The onset of localization is determined by a critical amount of shear heating, termed *Gruntfest* number, when dissipative work by temperature-sensitive creep translated into heat overcomes the diffusive capacity of the layer of a given thickness. Through an additional mathematical bifurcation analysis using constant stress boundary conditions, we test whether both structures develop at a same critical *Gruntfest* number. By means of alternating boundary conditions and parameter sensitivity studies, the numerical experiments reveal that folding develops for the same material parameters and power-law exponent as boudinage, by only inverting the sign of displacement. Boudinage and folding instabilities occur when the mechanical work, which is translated into heat, overcomes the diffusive capacity of the layer.

1) Karlsruhe Institute of Technology, Institute of Applied Geosciences, Geothermal Research, max.peters@kit.edu  
2) CSIRO Energy and Resources Group, Australia  
3) School of Petroleum Engineering, The University of New South Wales, Australia

Consequently, both instabilities develop for the same critical *Gruntfest* number (Peters et al., 2016). Further, we find that boudinage instability emerges for values of the stress exponent below  $n < 5$  and especially for a *Newtonian* response ( $n = 1$ ) of the layer. This finding implies that not only can folding and boudinage instabilities be treated as the same energy bifurcation, but also that the energy theory predicts boudinage in cases where classic theories anticipate no growth of the structure. Since the critical material parameters and boundary conditions for both structures to develop are found to coincide, the initiation of localized deformation in mechanically strong layered media within a weaker matrix can be captured by means of a unified theory for localization in ductile materials. In this energy framework, neither intrinsic nor extrinsic material weaknesses are required, as the nucleation process of strain localization arises out of homogeneous conditions. This finding allows us to approach localization problems as coupled rheological bifurcations and to describe folding and boudinage structures as the same energy attractor of ductile deformation.

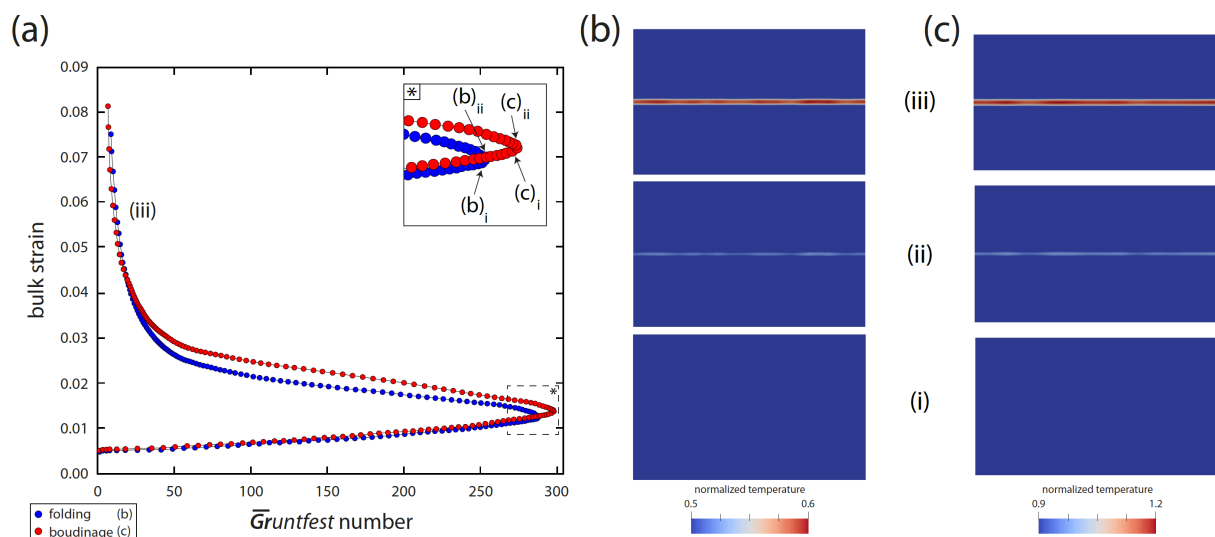

Figure 1. Comparison of the thermal and structural evolution during a folding and boudinage simulation. (a) With increasing energy input to the system, boudinage and folding instabilities occur at the same critical Gruntfest number. (b,c) Profiles of the temperature across the layer directly before (i) and right after (ii) the bifurcation point.

## References

- Gruntfest, I.J., 1963. Thermal feedback in liquid flow; plane shear at constant stress. *Transactions of the Society of Rheology* 7. doi:10.1122/1.548954.
- Hobbs, B.E., Regenauer-Lieb, K., Ord, A., 2010. Folding with thermal mechanical feedback: another reply. *Journal of Structural Geology* 32. doi:10.1016/j.jsg.2009.10.005.
- Peters, M., Herwegh, M., Paesold, M.K., Poulet, T., Regenauer-Lieb, K., Veveakis, M., 2016. Boudinage and folding as an energy instability in ductile deformation. *Journal of Geophysical Research Solid Earth*, 121, doi:10.1002/2016JB012801.
- Peters, M., Veveakis, M., Poulet, T., Karrech, A., Herwegh, M., Regenauer-Lieb, K., 2015. Boudinage as a material instability of elasto-visco-plastic rocks. *Journal of Structural Geology* 78. doi.org/10.1016/j.jsg.2015.06.005.
- Poulet, T., Paesold, M.K., Veveakis, M., 2016. Multi-physics modelling for fault mechanics using REDBACK: a parallel open-source simulator for tightly coupled problems. *Rock Mechanics and Rock Engineering*. doi:10.1007/s00603-016-0927-y [http://github.com/pou036/redback.git].
- Regenauer-Lieb, K., Yuen, D.A., 2003. Modeling shear zones in geological and planetary sciences: solid- and fluid thermal-mechanical approaches. *Earth-Science Reviews* 63. doi:10.1016/S0012-8252(03)00038-2.



## GeoProc2017

6th International Conference on Coupled THMC Processes in Geosystems  
5-7 Jul 2017 Paris (France)

### Numerical modelling of multi-physics instabilities using REDBACK

T. Poulet<sup>1</sup>, S. Alevizos<sup>2</sup>, M. Lesueur<sup>3</sup>, R. Tung<sup>4</sup>, V. Boussange<sup>5</sup>, E. Veveakis<sup>6</sup>

*Keywords: Multi-physics, Multi-scale, Pseudo Arclength Continuation, Localisation*

Localisation phenomena are of particular interest in geology, as scientists have been studying extensively geological features like faults, folds, or boudinage. Such features can involve more than one physical process and some of the most interesting and unsolved features are actually characterized by multiple processes. This is the case for example for chemical shear zones (Alevizos et al, 2014), which are responsible for Episodic Tremor and Slip events in active subduction zones or extremely thin shear zones with tens of kilometers of displacement in exhumed megathrusts (Poulet et al, 2014).

To investigate numerically such phenomena, we built REDBACK, an open-source parallel simulator for Rock mEchanics with Dissipative feedBACKs that was specially developed to simulate multi-physics processes. This finite-element simulator is built on the Multiphysics Object-Oriented Simulation Environment (MOOSE) framework (<http://mooseframework.org>), and implements a novel overstress plasticity model (Poulet & Veveakis, 2016). The strength of the code is to solve multiphysics problems with non-linear feedbacks in a tightly coupled manner, but it is also particularly well adapted to solve multi-scale problems by coupling simulations sequentially (see Fig.1).

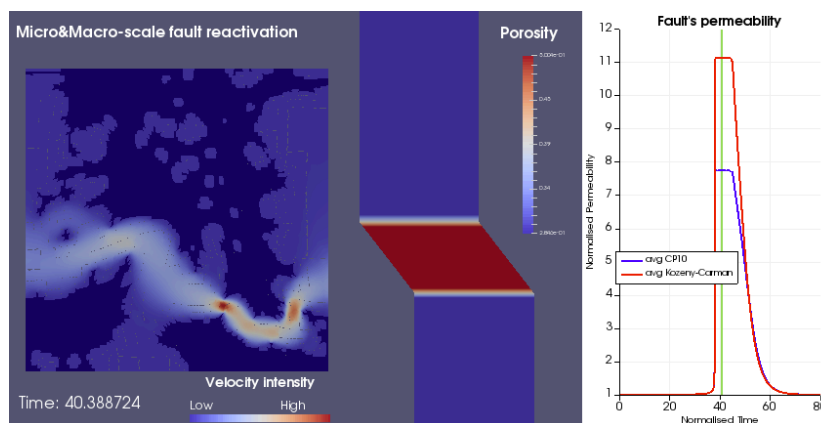

Figure 1. Coupling of shear zone simulation at the meter-scale with flow simulation at the micro-scale.

<sup>1</sup> CSIRO Mineral Resources, Sydney, Australia, [thomas.poulet@csiro.au](mailto:thomas.poulet@csiro.au)

<sup>2</sup> School of Petroleum Engineering, UNSW, Sydney, Australia, [s.alevizos@unsw.edu.au](mailto:s.alevizos@unsw.edu.au)

<sup>3</sup> School of Petroleum Engineering, UNSW, Sydney, Australia, [m.lesueur@unsw.edu.au](mailto:m.lesueur@unsw.edu.au)

<sup>4</sup> Curtin University, Perth, Australia, [rebecca.tung@postgrad.curtin.edu.au](mailto:rebecca.tung@postgrad.curtin.edu.au)

<sup>5</sup> INSA Lyon, France, [victor.boussange@insa-lyon.fr](mailto:victor.boussange@insa-lyon.fr)

<sup>6</sup> School of Petroleum Engineering, UNSW, Sydney, Australia, [e.veveakis@unsw.edu.au](mailto:e.veveakis@unsw.edu.au)

This versatile simulator has been used to study a variety of geological scenarios, often from a material instability perspective. In this contribution, we present a novel way to use REDBACK through a pseudo-arclength continuation algorithm to study the influence of any given numerical parameter on the stability of a system. We demonstrate this capability through the study of convective faulted systems, showing the importance of shear heating in active faults and its impact on lowering the minimum permeability required for the onset of convection (see Fig.2).

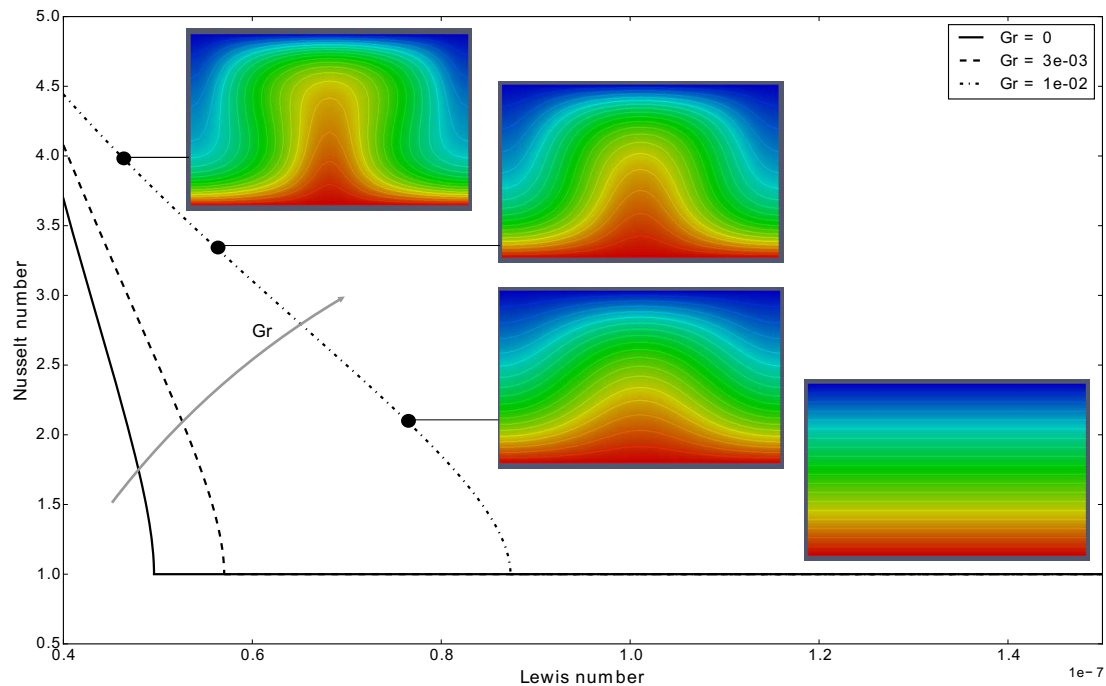

Figure 2. Stability analysis of a convective system with a creeping fault generating shear heating of different intensity (characterized by its Gruntfest number).

## References

- Alevizos, S., Poulet, T. and Veveakis, E. (2014) Thermo-Poro-Mechanics of chemically active creeping faults. 1: Theory and Steady-state considerations. *Journal of Geophysical Research: Solid Earth*, 2014, 119, 4558-4582, doi: 10.1002/2013JB010070
- Poulet, T., Veveakis, E., Herwegh, M., Buckingham, T., Regenauer-Lieb, K. (2014) Modeling episodic fluid-release events in the ductile carbonates of the Glarus thrust. *Geophysical Research Letters* 41 (20), 7121-7128. doi: 10.1002/2014GL061715
- Poulet, T., Veveakis, E. (2016) A viscoplastic approach for pore collapse in saturated soft rocks using REDBACK: an open-source parallel simulator for Rock mEchanics with Dissipative feedBACKs. *Computers and Geotechnics*. 2016, 74, 211 - 221 doi: 10.1016/j.compgeo.2015.12.015



## GeoProc2017

6th International Conference on Coupled THMC Processes in Geosystems  
5-7 Jul 2017 Paris (France)

### Localization of deformation in a fault gouge with Cosserat microstructure and THCM couplings

*Hadrien Rattetz<sup>1</sup>, Ioannis Stefanou<sup>1</sup>, Jean Sulem<sup>1</sup>, Manolis Veveakis<sup>2,3</sup> and Thomas Poulet<sup>3</sup>*

*Keywords: Strain Localization, fault gouge, THCM couplings, linear stability analysis, Finite Element modelling*

During seismic slip, many complex phenomena happen. Field observations of faults show the formation of a slip zone of finite but very small thickness, composed of cataclastic material due to excessive shearing (Engelder 1974). This zone is often called gouge. Outcrops indicate that an even thinner zone of ultracataclastic material, called principal slip zone (PSZ) exists inside the gouge (Rice 2006). The thickness of these zones is a key parameter for understanding fault behavior (Kanamori & Brodsky 2004) as it is related to the triggering and evolution of various multiphysical couplings and energy dissipation during seismic slip. From the mechanics point of view, in the gouge the deformations are localized in a shear band, whose thickness can be measured from field observations and laboratory tests. Strain localization in narrow bands can be seen as a bifurcation from the homogeneous deformation solution of the underlying mathematical problem, which is favored by softening behavior. The softening or weakening can be of mechanical origin (e.g. grain cataclasis, change of internal microstructure, reduction of internal friction etc.), of chemical reasons (Brantut & Sulem 2012) (e.g. dehydration, decarbonation, dissolution etc.) or it can be attributed to thermal effects (Rice 2006)(shear heating, thermal pressurization, thermal softening etc.).

Here we present a model for the shearing of a saturated rock layer under Thermo-Hydro-Chemo Mechanical (THCM) couplings (Veveakis et al. 2013; Sulem et al. 2011). A Cosserat elastoplastic behavior is used for the constitutive description of the gouge mechanical behavior. The Cosserat continuum contains 6 degrees of freedom for each material point: 3 translations and 3 rotations. It also introduces an internal length, which can be linked to the microstructure, into the constitutive parameters. It leads to a finite shear band thickness, information accessible from exhumed gouge samples. Moreover, the mechanical response of a Cosserat continuum is mesh-independent.

---

<sup>1</sup> Université Paris-Est, Laboratoire Navier/CERMES, Ecole des Ponts ParisTech, IFSTTAR, CNRS, 77455 Marne la Vallée, France. Hadrien.rattetz@enpc.fr, ioannis.stefanou@enpc.fr, jean.sulem@enpc.fr

<sup>2</sup> School of Petroleum Engineering, UNSW, Kensington, NSW 2033, Australia. e.veveakis@unsw.edu.au

<sup>3</sup> CSIRO, 11 Julius Avenue, North Ryde, NSW 2113, Australia. thomas.poulet@csiro.au

Thus, the energy during co-seismic slip is correctly described. On the contrary, the classical, Cauchy continuum is ill-posed leading to unphysical predictions.

Bifurcation theory allows for the calculation of the critical hardening modulus, under which the homogeneous state becomes unstable. An analysis of the wavelength of the perturbation applied to the system in the unstable regime enables to evaluate the evolution of the thickness of the localized zone. The effects induced by grain size reduction, pore fluid thermal pressurization and chemical reactions on the thickness are then investigated.

The mathematical system is integrated numerically using a fully coupled FEM code in order to study the post-bifurcation regime. The numerical analyses allowed to verify under which conditions the predictions of the shear band width by the linear stability analysis are correct. It enables also to have the mechanical response of the system and give an insight into the influence of different couplings in the energy budget of a seismic slip.

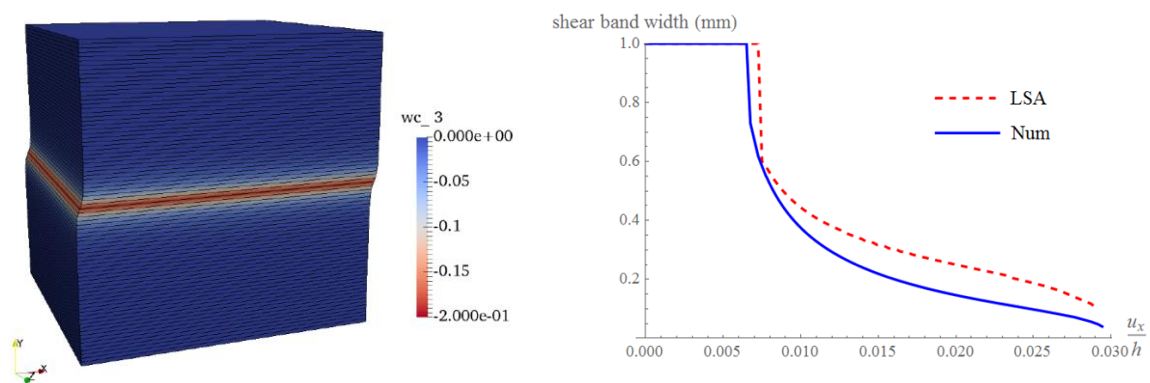

Figure 1. Cosserat rotation around the z-axis plotted on a deformed mesh (left). Comparison of the evolution of the shear band thickness obtained by linear stability analysis and FEM for a given negative hardening modulus (right).

## References

- Brantut, N. & Sulem, J., 2012. Strain Localization and Slip Instability in a Strain-Rate Hardening, Chemically Weakening Material. *Journal of Applied Mechanics*, 79(3), p.31004.
- Engelder, J.T., 1974. Cataclasis and the Generation of Fault Gouge. *Geological Society of America Bulletin*, 85(10), p.1515.
- Kanamori, H. & Brodsky, E.E., 2004. The physics of earthquakes. *Reports on Progress in Physics*, 67(8), pp.1429–1496.
- Rice, J.R., 2006. Heating and weakening of faults during earthquake slip. *Journal of Geophysical Research: Solid Earth*, 111(5).
- Sulem, J., Stefanou, I. & Veveakis, M., 2011. Stability analysis of undrained adiabatic shearing of a rock layer with Cosserat microstructure. *Granular Matter*, 13(3), pp.261–268.
- Veveakis, M., Stefanou, I. & Sulem, J., 2013. Failure in shear bands for granular materials: thermo-hydro-chemo-mechanical effects. *Géotechnique Letters*, 3(April-June), pp.31–36.



## GeoProc2017

6th International Conference on Coupled THMC Processes in Geosystems  
5-7 Jul 2017 Paris (France)

### Numerical analysis of strain localization in a Cosserat continuum with THM couplings

*Hadrien Rattetz<sup>1</sup>, Ioannis Stefanou<sup>1</sup>, Jean Sulem<sup>1</sup>, Manolis Veveakis<sup>2,3</sup> and Thomas Poulet<sup>3</sup>*

*Keywords: Strain Localization, fault gouge, THM couplings, linear stability analysis, Finite Element modelling*

When materials are subjected to large deformations, most of them experience inelastic deformations. It is often accompanied by a localization of these deformations into a narrow zone leading to failure. Modelling localized deformations in any type of materials is a challenging task due to the complications that arise while dealing with a softening behavior.

Localization is seen as an instability from the homogeneous state of deformation. Therefore a first approach to study it consists at looking at the possible critical conditions for which the constitutive equations of the material allow a bifurcation point (Rudnicki & Rice 1975; Hill 1958). But in some cases, we would like to know the evolution of the material after the onset of localization. For example, a fault in the crustal part of the lithosphere is a shear band and the study of this localized zone enables to extract informations about earthquakes nucleation (Platt et al. 2014). For that, we need to approximate the solution of a nonlinear boundary value problem numerically. Moreover, the classical continuum theory cannot be used because the governing system of equations is ill-posed (Vardoulakis 1985). This ill-posedness can be tracked back to the fact that constitutive models don't contain material parameters with the dimension of a length and thus the size of the localized zone is undetermined. A way to regularize the problem is to resort to continuum models with microstructure, such as Cosserat continua (Mühlhaus & Vardoulakis 1987; Sulem et al. 2011) .

Cosserat theory is particularly interesting as it can explicitly take into account the size of the grains in a fault gouge. Basically, it introduces 3 degrees of freedom of rotation on top of the 3 translations (Godio et al. 2016).

In this paper, the original work of (Mühlhaus & Vardoulakis 1987) is extended in 3D and thermo-hydro mechanical couplings are added to the model to study fault system

---

<sup>1</sup> Université Paris-Est, Laboratoire Navier/CERMES, Ecole des Ponts ParisTech, IFSTTAR, CNRS, 77455 Marne la Vallée, France. Hadrien.rattetz@enpc.fr, ioannis.stefanou@enpc.fr, jean.sulem@enpc.fr

<sup>2</sup> School of Petroleum Engineering, UNSW, Kensington, NSW 2033, Australia. e.veveakis@unsw.edu.au

<sup>3</sup> CSIRO, 11 Julius Avenue, North Ryde, NSW 2113, Australia. thomas.poulet@csiro.au

in the crustal part of the lithosphere. The system of equations is approximated by Finite Element using Redback, an application based on the Moose software (Gaston et al. 2009; Poulet et al. 2016). It enables us to study the weakening effect of the couplings on a fault system modelled as an infinite sheared layer and follow the evolution of the shear band thickness in the post-bifurcation regime (Figure1).

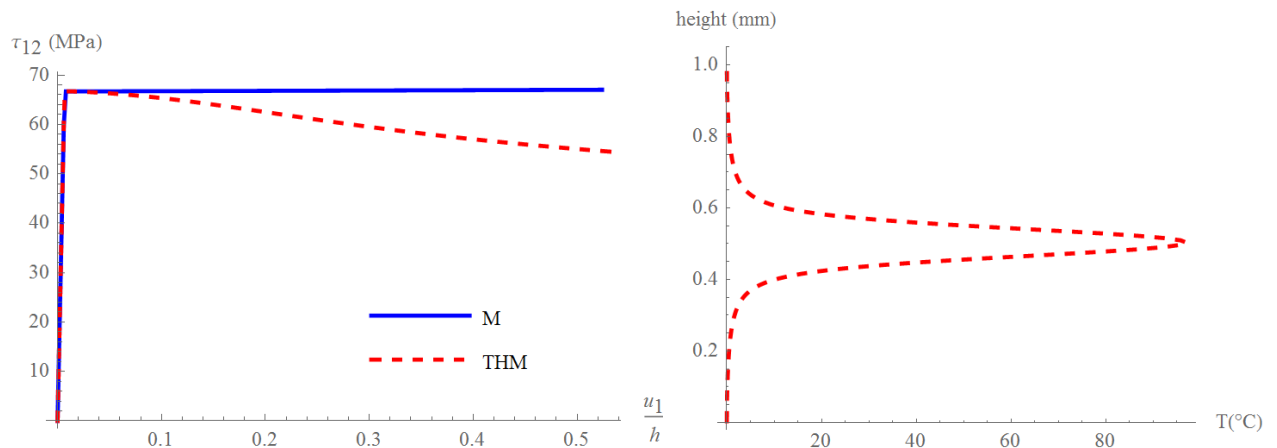

Figure 1. (Left) Effect of THM couplings on the stress-strain diagram compared to the purely mechanical one (no localization). (Right) Localization of the temperature at last time step for the THM model.

## References

- Gaston, D. et al., 2009. MOOSE: A parallel computational framework for coupled systems of nonlinear equations. *Nuclear Engineering and Design*, 239(10), pp.1768–1778.
- Godio, M. et al., 2016. Multisurface plasticity for Cosserat materials: plate element implementation and validation. *International Journal for Numerical Methods in Engineering*.
- Hill, R., 1958. A general theory of uniqueness and stability in elastic-plastic solids. *Journal of the Mechanics and Physics of Solids*, 6(3), pp.236–249.
- Mühlhaus, H.-B. & Vardoulakis, I., 1987. The thickness of shear bands in granular materials. *Géotechnique*, 37(3), pp.271–283.
- Platt, J.D., Rudnicki, J.W. & Rice, J.R., 2014. Journal of Geophysical Research : Solid Earth Stability and localization of rapid shear in fluid-saturated fault gouge : 2 . Localized zone width and strength evolution. *Journal of Geophysical Research: Solid Earth*.
- Poulet, T., Paesold, M. & Veveakis, M., 2016. Multi-Physics Modelling of Fault Mechanics Using REDBACK: A Parallel Open-Source Simulator for Tightly Coupled Problems. *Rock Mechanics and Rock Engineering*, pp.1–17.
- Rudnicki, J.W. & Rice, J.R., 1975. Conditions for the localization of deformation in pressure-sensitive dilatant materials. *Journal of the Mechanics and Physics of Solids*, 23(6), pp.371–394.
- Sulem, J., Stefanou, I. & Veveakis, M., 2011. Stability analysis of undrained adiabatic shearing of a rock layer with Cosserat microstructure. *Granular Matter*, 13(3), pp.261–268.
- Vardoulakis, I., 1985. Stability and bifurcation of undrained, plane rectilinear deformations on water-saturated granular soils. *International Journal for Numerical and Analytical Methods in Geomechanics*, 9(5), pp.399–414.





## GeoProc2017

6th International Conference on Coupled THMC Processes in Geosystems  
5-7 Jul 2017 Paris (France)

### Multiscale THMC Coupling for Next Generation Reservoir Engineering

*Klaus Regenauer-Lieb<sup>1</sup> and the UGG-Team<sup>2</sup>*

*Keywords: Multiscale Data Assimilation, Unconventional Resources, Geodynamics*

The Unconventional Geomechanics Team (*UGG-Team*) is using knowledge about THMC processes to replace the current empirically based geomechanics theories by a fundamental physics-based geomechanics approach. We advance knowledge about an Integrated **Computational Materials Engineering** [*ICME*, 2008] approach for geosciences (dubbed “*Next Generation Reservoir Engineering*”).

Our approach is based on a thermodynamic continuum framework that specifies material uncertainties through averaging of cross-scale coupling of the THC reaction-diffusion processes using maximum and minimum entropy production bounds. We first integrate the steady solutions of the THC reaction-diffusion equations for maximum entropy production and identify multiple steady states which can be characterized by their corresponding diffusion lengths:

$$L_{(T,H,C)} = 2\sqrt{\kappa_{(T,H,C)}t_s} \quad (1)$$

where  $L_{(T,H,C)}$  is the diffusion length scale for the time to reach steady state time  $t_s$  and  $\kappa_{(T,H,C)}$  are the respective THC diffusivities. Multiple steady states are separated by system transients which are characterized by multi-scale localization phenomena. These are based on reaching a criterion derived from a stability analysis. These stability limits can be mapped by non-dimensional numbers, the **Gruntfest number** (T) the **Lewis number** (H) and the **Damköhler number** (C) defining the critical multi-scale ratios of reaction over diffusion rates, or in other words the ratios of characteristic diffusion over reaction time scales.

Cross-scale couplings, based on the underlying physics, can be considered in specific formulations of the critical numbers. These formulations can be directly derived from the terms in the THC reaction-diffusion equations. As an example, the Gruntfest  $Gr$  number can be defined by:

$$Gr = \frac{t_s}{t_a} \quad (2)$$

where  $t_s$  is the time scale defined in equation (1);  $t_a$  is the characteristic time for the adiabatic limit of the energy equation, obtained by setting the diffusion term to zero. Any other energy sink/source process relevant at the thermal diffusion length scale, defined

<sup>1</sup> UNSW Sydney, School of Petroleum Engineering, klaus@unsw.edu.au

<sup>2</sup> UNSW Sydney, School of Petroleum Engineering, unsw.ugg@gmail.com

in eq. (1) and cascaded from smaller scale, may thus be considered in the formulation. When applying the above described physics based framework to reservoir engineering problems we identify two fundamentally different cases.

**CASE1:**  $L_T \gg L_H \gg L_C$ : Thermal, hydraulic and chemical length scales are very far apart. Through lack of cross-scale coupling between chemical, fluid and thermal diffusion each individual scale can reach its long-time scale steady state where reaction and diffusion are in equilibrium. The final steady state is still defined by the largest hierarchical driver, the kilometre scale equilibrium between shear heating and thermal diffusion, which allows us to simplify the assumptions for future data assimilation methods. Thus, we can solve at each particular scale of observational data the coefficients of the underpinning non-linear partial differential reaction-diffusion equations by standard inversion methods. Time-series data are not necessary as the system has reached steady state and the diffusivity can be derived from the width of the localization (shear) zones. The physical meaning of the coefficients are rate constants determining the rate of reaction (shear heating, fluid production and chemical reaction) and the rates of diffusion (thermal, fluid and chemical diffusivities).

**CASE2:**  $L_T \geq L_H \geq L_C$ : Feedback processes involving the full cross-scale communication between chemical fluid release reactions in conjunction with fluid-feedback and thermal feedback. This feedback mechanism operates on the full cascade of reaction-diffusion equations from Fick to Darcy to Fourier controlled and can be extremely powerful. This THMC feedback leads to complex oscillatory weakening behaviour which forms a material specific energy attractor with a complex dynamic regime. Data assimilation for this more complicated case are also available [Abarbanel *et al.*, 2008] but they require time-series. The identification of the dynamic system and determination of the coefficients of the partial differential equations can be derived from an observation window of a time series of the dynamic response.

In summary, next generation reservoir engineering opens the path for multi-scale data assimilation to seamlessly assess the large scale geodynamic driver down to nano-scale rock physics. The ICME approach allows us explicitly to link processes from long-term physics, transcending human life, to engineering time scales.

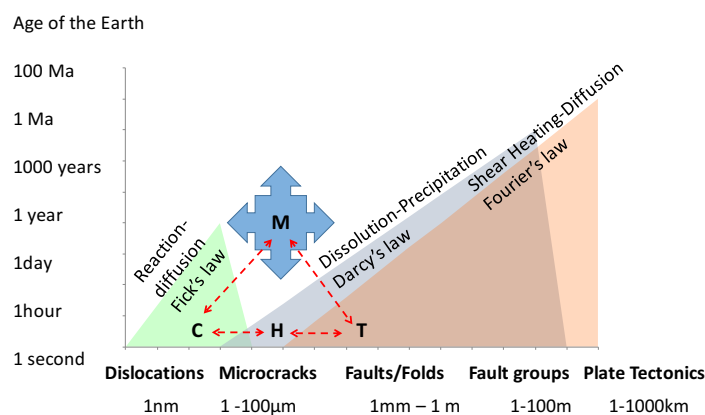

## References

- Abarbanel, H. D. I., D. R. Creveling, and J. M. Jeanne (2008), Estimation of parameters in nonlinear systems using balanced synchronization, *Physical Review E*, 77(1), 016208.
- ICME (2008), *Integrated Computational Materials Engineering: A Transformational Discipline for Improved Competitiveness and National Security* The National Academies Press, Washington DC.



## GeoProc2017

6th International Conference on Coupled THMC Processes in Geosystems  
5-7 Jul 2017 Paris (France)

### Earthquake cycles in geometrically complex faults with ageing rate and state friction

*P. Romanet<sup>1, 2</sup>, H. S. Bhat<sup>2</sup>, R. Madariaga<sup>3</sup>*

*Keywords: earthquake cycles, rate and state friction, slow-slip, Fast Multipole Method*

Physics based earthquake cycle modeling is a key tool to understand the interplay between interseismic loading and seismic ruptures on frictionally complex faults. However, a severe restriction in this type of modeling is that faults are forced to be planar due to numerical reasons. Natural faults are nowhere close to this planarity assumption.

Keeping that in mind, we wanted to investigate the role of the geometry of faults (multiple interacting faults, bend, kinks etc.) on the earthquake cycle. To build a model of geometrically complex faults, we used a quasi-dynamic response of the fault (anti-plane) with radiation damping term. The fault system is loaded using a constant shear stress rate. And finally, the total shear stress acting on the fault is balanced by the fault strength modeled using rate-and-state friction law with ageing state evolution law (Dieterich, 1979).

However, calculating the quasi-dynamic response of a fault, over many earthquake cycles, can be computationally intensive and the requirement that the model must work for complex geometry and multiple faults prevents us from using classical accelerating technics such as Fast Fourier Transform. This is why we appeal to the Fast Multipole Method (FMM) to accelerate the calculation. FMM was developed in the context of modeling N-body problems (Greengard and Rokhlin, 1987). This method is based on the fact that if a part of a fault is slipping, the elastic stress potential field far from this part is quite smooth and can be represented in a compressed form by the means of multipole and local expansion. Using FMM allowed us to decrease the complexity of calculation from  $O(N^2)$  to  $\sim O(M \log N)$ ,  $N$  being the number of discretized points on the fault. We modeled a system of two parallel rate-weakening faults, offset from each other, for different fault lengths and different distance between them. The friction on the two faults is such that the faults are rate weakening (i.e.  $a-b < 0$  or  $a/b < 1$  in rate-and-state framework), with homogenous and same friction properties for both faults. We also explore different friction for the faults, from highly rate-weakening faults ( $0 < a/b \ll 1$ ) to mildly rate-weakening ( $a/b \lesssim 1$ ). Under such uniform conditions, a single fault would predict periodic earthquake ruptures and locked inter seismic period (Figure 1a). However, the presence of the second fault breaks this periodicity (Figure 1b) and results in both slow dynamical response (slow slip events) and fast dynamical response

<sup>1</sup> Institut de Physique du Globe de Paris, romanet@ipgp.fr

<sup>2</sup> Ecole Normale Supérieure, bhat@geologie.ens.fr

<sup>3</sup> Ecole Normale Supérieure, madariag@geologie.ens.fr

(earthquakes). The final seismic moment,  $M$ , of our slow slip events is proportional to the duration of the event,  $T$ . While the final seismic moment of earthquake ruptures are proportional to  $T^2$  (in 2D while  $T^3$  in 3D). Both of these scaling's agree perfectly with observations made for natural slow slip events and earthquakes (Figure 2).

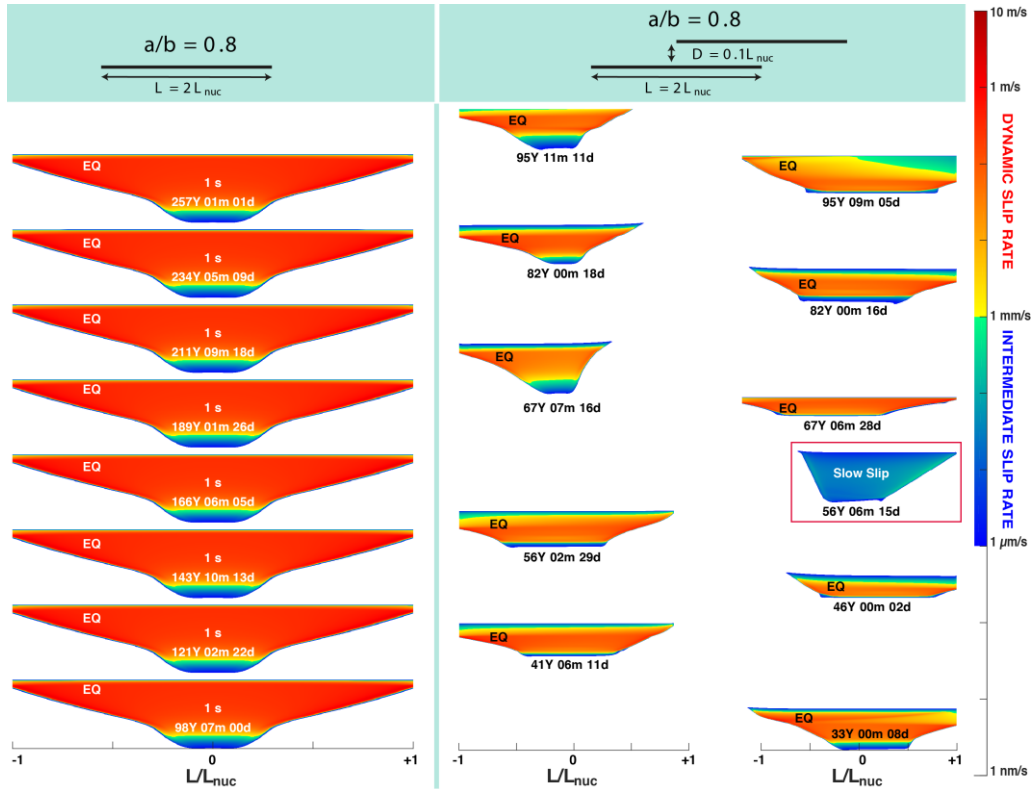

Figure 1. Earthquake cycles on single (a) and multiple faults (b). The contours represent slip velocity on the fault.

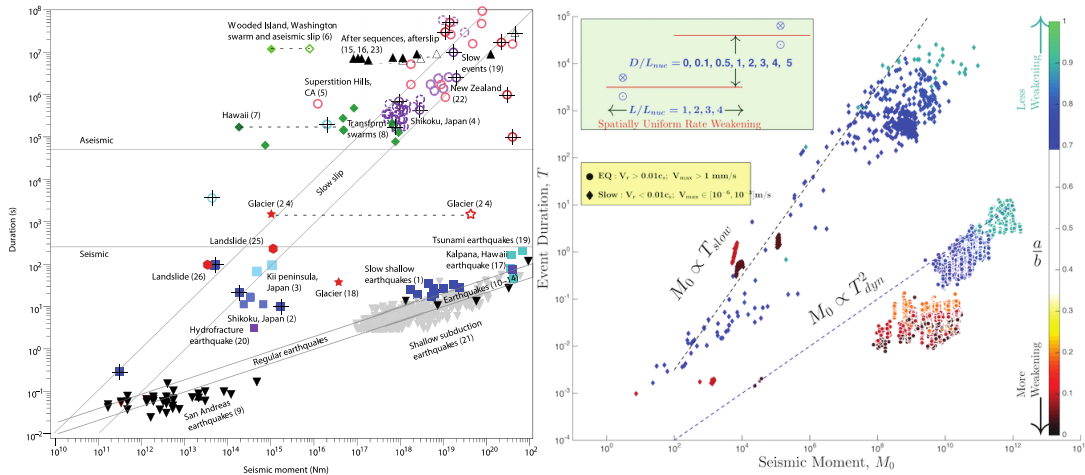

Figure 2. Seismic Moment vs. Duration of the event from observations (a) and from numerical modeling (b).

## References

Dieterich, J. H. (1979), Modeling of rock friction 1. Experimental results and constitutive equations, *J. Geophys. Res.*, 84, B5, 2161---2168.

Greengard, L. and Rokhlin, V. (1987), A fast algorithm for particle simulations, *J. Comput. Phys.*, 73, 2, 325–348.



## GeoProc2017

6th International Conference on Coupled THMC Processes in Geosystems  
5-7 Jul 2017 Paris (France)

### Hydro-mechanical modelling of a gallery sealing over the entire life of a deep repository

*D.F. Ruiz<sup>1</sup>, J. Vaunat<sup>2</sup>, A. Gens<sup>3</sup>, M. Mánica<sup>4</sup>*

*Keywords: Nuclear waste repository, claystones, anisotropy, bentonite, gaps.*

A deep nuclear waste repository implies several types of excavation. The seal structure evaluated in this work concern to the arrangement designed to isolate the connecting galleries, ramps and shafts after the operational phase of the repository (Figure 1). The response of the sealing system involves the entire life of the repository, including the construction and the operational phase. A numerical modelling of the short and long term hydro-mechanical response of typical sealing systems placed in the main galleries of a repository located in claystone is presented. Geometrical aspects (joints, gaps, etc.) and viscous and anisotropy behaviour of the host rock are take into account in order to obtain a realistic response of the system.

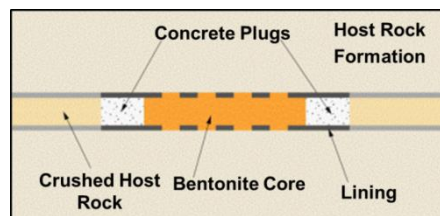

*Figure 1. Configuration of the seal structure.*

**Host rock modelling:** Due to the characteristics of sealing systems, a hydro-mechanical (HM) analysis of the behaviour of the host rock is necessary. Although the seal system is applicable to any type of host rock, the study is focussed on the Callovo-Oxfordian (COx) claystone. It is simulated by a phenomenological model through a visco-elastoplastic stress-strain relationship based on linear elasticity and Mohr-Coulomb yield criterion. The following features are also incorporated:

- Non-linear hardening softening Law.
- Anisotropic failure criterion (Mánica et al; 2016).
- Creep deformations using a modified Lemaitre's Law in which long term deformations are functions of the deviatoric stress.

<sup>1</sup> Universitat Politècnica de Catalunya (UPC), daniel.felipe.ruiz@upc.edu

<sup>2</sup> Universitat Politècnica de Catalunya (UPC), jean.vaunat@upc.edu

<sup>3</sup> Universitat Politècnica de Catalunya (UPC), antonio.gens@upc.edu

<sup>4</sup> Universitat Politècnica de Catalunya (UPC), miguel.angel.manica@estudiant.upc.edu

Concerning hydraulic phenomena, the Van Genuchten retention curve, the variation of the intrinsic permeability  $K_i$  with porosity and the variation of the relative hydraulic conductivity with degree of saturation  $S_r$  are required (DIT-UPC, 2002).

**Contact effects:** The installation of seal structure involves contacts between the different components. The implementation of a hydro-mechanical joint element formulated by Zandarín (2010) in the finite element code CODE-BRIGHT (DIT-UPC, 2002) was performed.

**Expansive behaviour of the bentonite core:** The central part of the seal structure is the expansive core composed by bentonite. The main feature of these materials is a double structure in which microporosity inside clay aggregates coexists with the macroporosity. With a simple structure approach is possible generate a progressive swelling upon hydration. A modified version of the elastic law of the Barcelona Basic Model (Alonso 1990) has been used. To model features such as transient collapse of the macrostructure and the evolution of the macro-micro porosity a double structure modelling approach can be implemented.

Finally, to solve the boundary value problem that defines the modelling the field equations related to mass balance of solid and water and the balance of momentum are solved in the finite element code CODE-BRIGHT (DIT-UPC, 2002). The modelling considers a bi-dimensional and axisymmetric geometry around the axis of the gallery. Considering the joint element in a realistic way, a longitudinal displacement of the plugs (0.20 m) is computed and the longitudinal stresses vanish near the plugs. However, a central part of the core maintains the high swelling pressure and the radial pressure is constant along the gallery due to the lining (Figure 2).

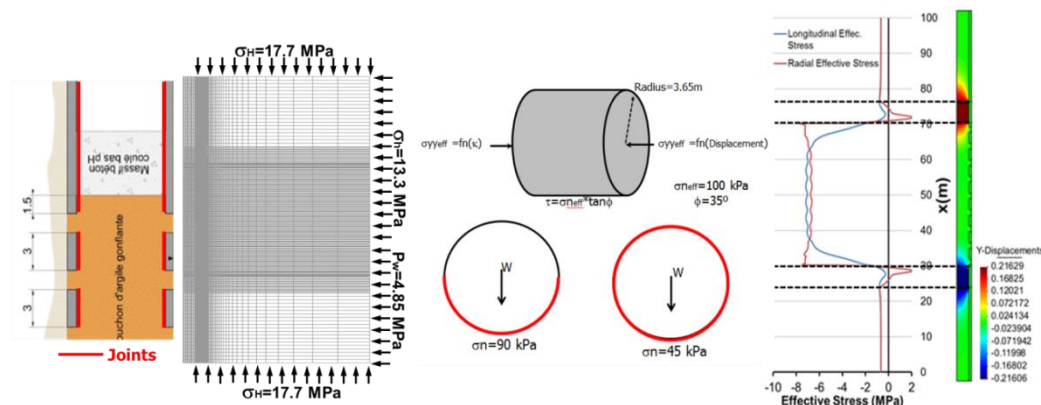

Figure 2. Model and mesh features (Left). Plugs stability (Right).

## References

- Alonso, E.E. Gens, A. Josa, A. (1990). Géotechnique 40, No. 3. 405-430. A constitutive model for partially saturated soils.
- DIT-UPC (2002). CODE\_BRIGHT, a 3-D program for Thermo-Hydro-Mechanical analysis in geological media: User's guide, CIMNE, Barcelona.
- Mánica, M. A., Gens, A., Vaunat, J., & Ruiz, D.F. (2016). Géotechnique Letters 6, 1–7. A cross-anisotropic formulation for elasto-plastic models.
- Zandarín, M. T. (2010). "Thermo-Hydro-Mechanical analysis of joints - A theoretical and experimental study". PhD Thesis. Universitat Politècnica de Catalunya (UPC).



## GeoProc2017

6th International Conference on Coupled THMC Processes in Geosystems  
5-7 Jul 2017 Paris (France)

### **Coupled fluid flow and geomechanical modeling studies on fault activation, induced seismicity and potential fault leakage in geologic carbon storage**

*J. Rutqvist<sup>1</sup>, A.P. Rinaldi<sup>1,2</sup>, F. Cappa<sup>1,3</sup>, P. Jeanne<sup>1</sup>, A. Mazzoldi<sup>1,4</sup>, L. Upr<sup>2</sup>, Y. Guglielmi<sup>1</sup>, V. Vilarrasa<sup>1,5</sup>*

*Keywords: CO<sub>2</sub> storage, induced seismicity, fault activation, modeling*

The potential for activating faults associated with geologic carbon sequestration is currently receiving increased attention among CO<sub>2</sub> sequestration stakeholders as an issue of concern both related to induced seismicity and CO<sub>2</sub> leakage (Rutqvist, 2012; Rutqvist et al., 2014). In the light of these concerns, findings from recent modeling studies are summarized with emphasis on CO<sub>2</sub> injection and storage in deep sedimentary formations (Rutqvist et al., 2016). The model simulations show that seismic magnitude and potential for creating a leakage path through overburden sealing layers (caprock) depends on a number of parameters such as fault orientation, stress field, injection location relative to the fault, and rock properties. The model simulations further demonstrate that seismic events large enough to be felt by humans requires brittle fault properties and continuous fault permeability that allows for the pressure to be distributed over a sufficiently large fault patch that can be ruptured in one larger fault rupture. For example, a fault rupture size on the order of 1 km would be required to trigger a magnitude 4 event that for a shallow injection-induced event could be widely felt on the ground surface. Heterogeneous fault properties which are commonly encountered in faults intersecting multilayered shale/sandstone sequences effectively reduce the likelihood of inducing felt seismicity and also effectively impede upward CO<sub>2</sub> leakage. A number of simulations show that even a sizable seismic event that could be felt may not be capable of opening of a new permeable flow path across the entire thickness of an overlying caprock and is very unlikely to cross a system of multiple overlying caprock units. Based on results of summarized modeling studied and an increasing number of field observations correlating deep fluid injection with induced seismicity, we emphasize the importance of the site investigation to characterize rock properties. This is critical to, if at all possible, avoid brittle rock such as crystalline basement or sites in hard and brittle sedimentary sequences that are more prone injection-induced seismicity and permanent damage.

<sup>1</sup>Lawrence Berkeley National Laboratory (LBNL), Berkeley, USA, jrutqvist@lbl.gov

<sup>2</sup>Swiss Federal Institute of Technology (ETHZ), Zürich, Switzerland, antoniopio.rinaldi@sed.ethz.ch

<sup>3</sup>GéoAzur, University of Nice Sophia-Antipolis, Nice, France, cappa@geoazur.unice.fr

<sup>4</sup>Instituto de Investigaciones en Ciencias de la Tierra, Morelia, Mexico, amazzoldi@lbl.gov

<sup>5</sup>Institute of Environmental Assessment and Water Res., Barcelona, Spain victor.vilarrasa@upc.edu

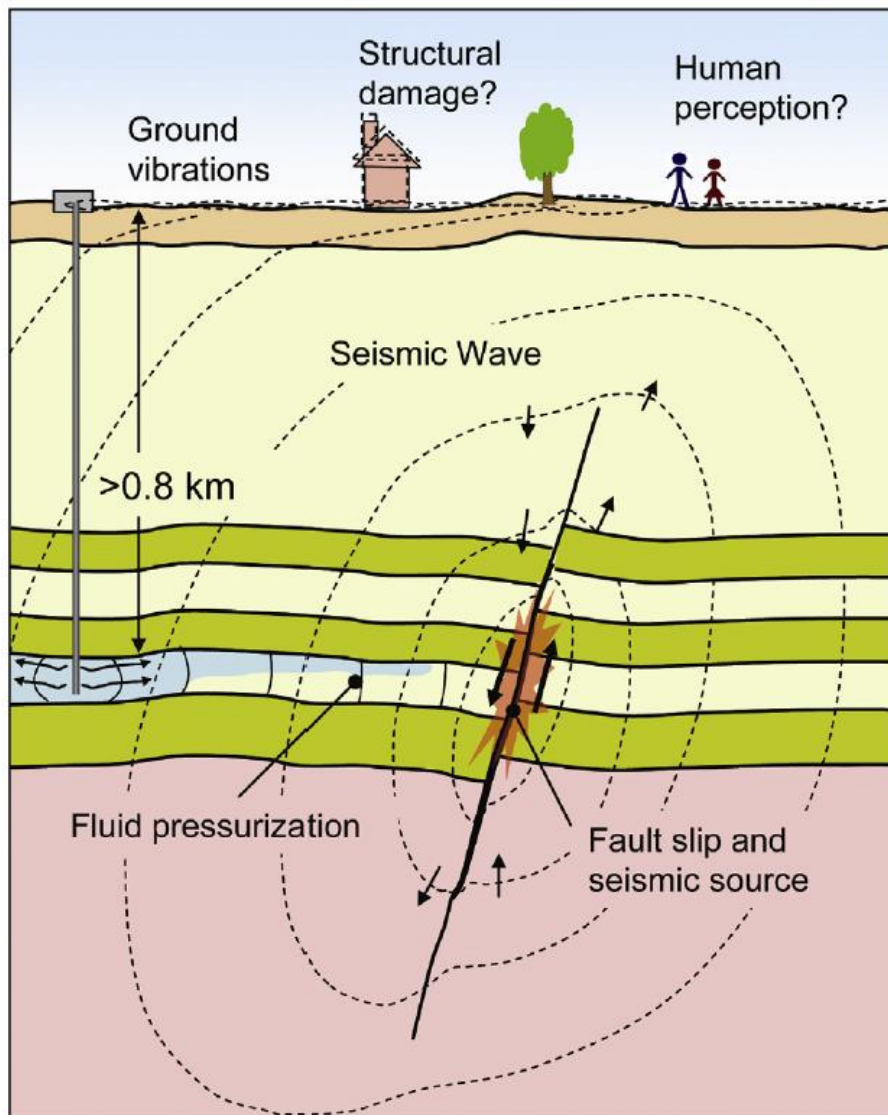

Figure 1. Schematic of CO<sub>2</sub>-injection-induced fault activation and potential impact on surface structures and human perception (Rutqvist et al., 2016).

## References

- Rutqvist, J. (2012), The geomechanics of CO<sub>2</sub> storage in deep sedimentary formations, *Geotechnical and Geological Engineering*, 30(3), 525-551.
- Rutqvist, J., F. Cappa, A.P. Rinaldi, and M. Godano (2014), Modeling of induced seismicity and ground vibrations associated with geologic CO<sub>2</sub> storage, and assessing their effects on surface structures and human perception, *International Journal of Greenhouse Gas Control*, 24, 64-77.
- Rutqvist, J., A.P. Rinaldi, F. Cappa, P. Jeanne, A. Mazzoldi, L. Urpi, Y. Guglielmi, and V. Vilarrasa (2016), Fault activation and induced seismicity in geologic carbon storage - Lessons learned from recent modeling studies, *Journal of Rock Mechanics and Geotechnical Engineering*, 8, 775-966.





## GeoProc2017

6th International Conference on Coupled THMC Processes in Geosystems  
5-7 Jul 2017 Paris (France)

### The effects of temperature perturbation and chemical reactions on flow-channeling in fractured geothermal doublets

S. Salimzadeh<sup>1</sup>, H. M. Nick<sup>2</sup>

*Keywords: Thermo-poroelasticity, Fractured geothermal doublets, Chemical reactions*

Sustainable and successful energy recovery from deep geothermal reservoirs requires a comprehensive understanding of how different local scale physical and chemical processes affect the short and long term heat transport. Fractured geothermal doublets are susceptible to short-circuiting, in which the residence time of the fluid is shortened, leading to reduced efficiency of the geothermal system (Figure 1). Fractures are thought to be the main contributor to this shortcoming by providing flow channels that act as shortcut between the injector and the producer (Figure 2).

In this study, a fully coupled three-dimensional finite element model is presented. Fractures are treated as surface discontinuities that cut through the 3D matrix. The aperture of the fracture is explicitly determined from the displacements of two opposite sides of the fracture. Laminar flow is considered within fracture, and coupled to the Darcy flow within three-dimensional matrix. Non-isothermal flow is modelled by solving advective-diffusive heat transport within the flow in fracture and matrix (Salimzadeh et al., 2016). The chemical reactions are also affecting the fracture aperture and matrix porosity (Deng et al., 2016). The effects of chemical reactions on altering fracture apertures and matrix porosity are also accounted for by using a reactive transport model. The coupled THMC model is validated against several benchmark examples and employed to study the effect of different physical and chemical processes on energy production in a geothermal doublet.

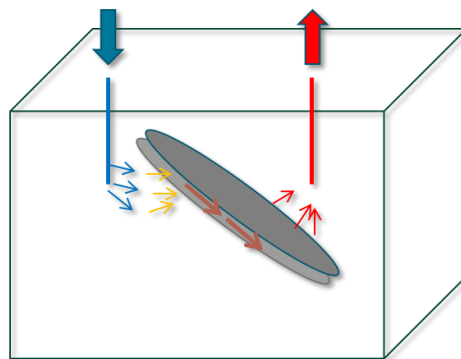

Figure 1. Schematic representation of a fractured geothermal doublet.

<sup>1</sup> Centre for Oil and Gas, Technical University of Denmark, saeeds@dtu.dk

<sup>2</sup> Centre for Oil and Gas, Technical University of Denmark, hamid@dtu.dk

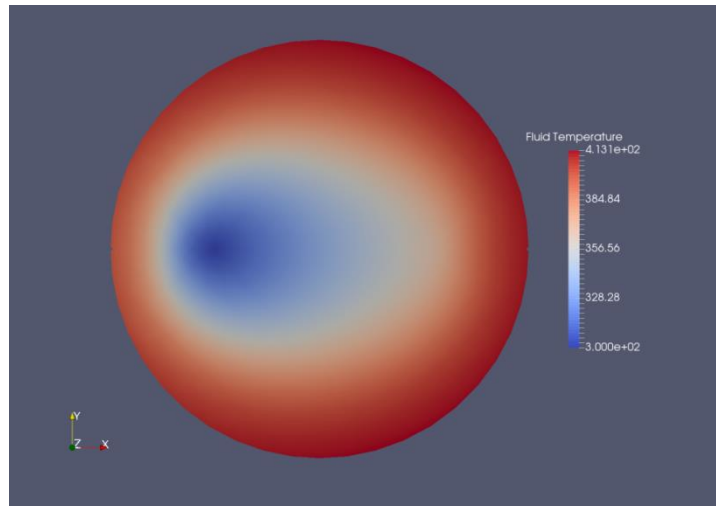

Figure 2. Flow channeling inside a fracture in a fractured geothermal doublet.

## References

- Salimzadeh, S., A. Paluszny, and R.W. Zimmerman (2016), Thermal Effects during Hydraulic Fracturing in Low-Permeability Brittle Rocks, *50th U.S. Rock Mechanics Symposium*, 26–29 June 2016, Houston, Texas.
- Deng, H., S. Molins, C. Steefel, D. DePaolo, M. Voltolini, L. Yang, and J. Ajo-Franklin (2016), A 2.5D reactive transport model for fracture alteration simulation, *Environmental Science and Technology* 50, 7564–7571.



## GeoProc2017

6th International Conference on Coupled THMC Processes in Geosystems  
5-7 Jul 2017 Paris (France)

### **Modelling of the poro-elastoplastic behavior of an early-age cement paste: application to well cementing**

*M. Samudio<sup>1</sup>, N. Agofack<sup>1,2</sup>, S. Ghabezloo<sup>1</sup>, J. Sulem<sup>1</sup>, A. Garnier<sup>3</sup>, C. Urbanczyk<sup>3</sup>*

*Keywords: cement, early-age, well cementing, elastoplasticity*

The prediction of the performance of cement-based materials requires a holistic model integrating the progressive hydration of the material, the coupling between water consumption and strains, and the history of the applied loadings. This is particularly important for modelling the behavior of the cement sheath in oil wells (Figure 1) which is subjected, from its earliest age and during its lifetime, to a wide range of mechanical and thermal loadings. Setting conditions such as pressure, temperature and subsequent loadings could have a detrimental effect on the future mechanical properties.

In the present work, the behavior of cement paste is described in the framework of reactive porous media. The cement paste is modelled as a multi-phase porous material with an elastoplastic constitutive law, with elastic and plastic parameters depending on function of the hydration degree. Furthermore, the pore water consumption during hydration and the cement chemical shrinkage are accounted for in the determination of the macroscopic shrinkage.

The model parameters for a class G cement paste are evaluated by simulating the results of mechanical loading experiments, performed using the STCA (Slurry To Cement Analyzer, Figure 2) in oedometric configuration. The STCA, conceived by TOTAL, is a device specially designed for testing the thermo-mechanical behavior of cement paste from the early stages of hydration. The macroscopic deformation of a cement paste sample is recorded continuously during hydration under constant axial stress and later on under loading-unloading cycles.

The evolution of the poroelastic parameters of the cement paste during hydration is calculated by means of a micromechanical upscaling model. A Drucker-Prager type yield surface with a cap and a non-associated flow rule are adopted for the elastoplastic regime, with hardening mechanisms considering both the cumulated plastic deformations and the hydration degree. A water retention curve is introduced to account for the potential desaturation of the material during hydration.

The results show that the proposed model predicts with good accuracy the response of a hydrating cement paste when subjected to various loading paths from its early age. The importance of the loading history is outlined, as well as the need for the

<sup>1</sup> Laboratoire Navier, UMR 8205, École des Ponts, IFSTTAR, CNRS, UPE, Champs-sur-Marne, France

<sup>2</sup> Currently at SINTEF, Norway.

<sup>3</sup> TOTAL CSTJF, Pau, France

accurate determination of the effective stresses in partially saturated conditions throughout the early age, especially for low-pressure curing conditions. Partial saturation is shown to have a significant effect on the effective loading path of the specimen.

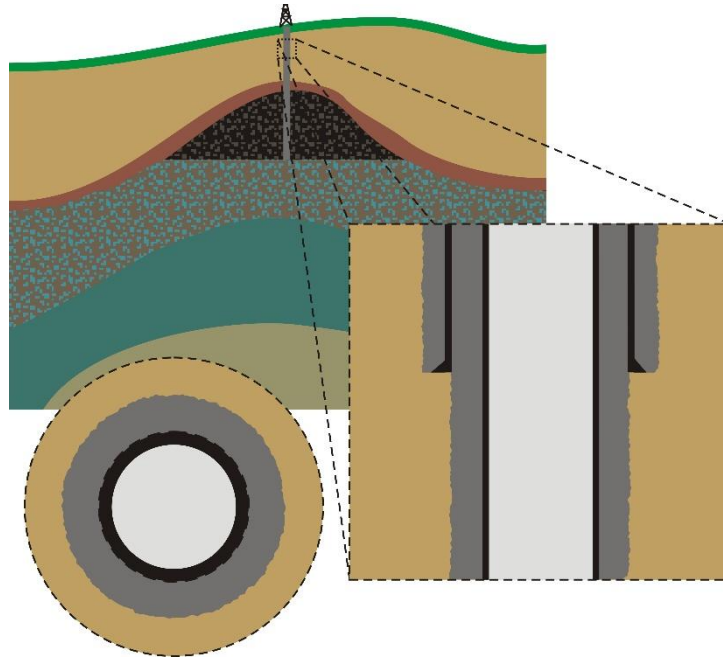

Figure 1. Schematic view of a well architecture (Ghabezloo, 2008)

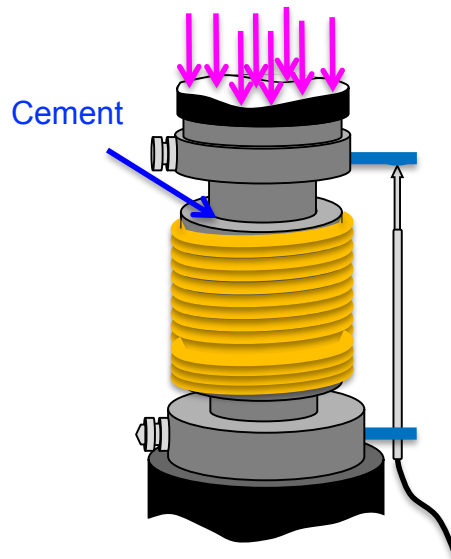

Figure 2. Slurry To Cement Analyzer STCA (Agofack, 2010)

## References

- Ghabezloo, S (2008). Comportement thermo-poro-mécanique d'un ciment pétrolier, PhD thesis, Ecole des Ponts ParisTech, France.
- S. Ghabezloo, J. Sulem, S. Guedon, F. Martineau, J. Saint-Marc (2008). Poromechanical behaviour of hardened cement paste under isotropic loading, *Cement and Concrete Research* 38 1424–1437.
- Agofack, N (2015). Comportement des ciments pétroliers au jeune âge et intégrité des puits. PhD thesis. Université Paris-Est, France.



## GeoProc2017

6th International Conference on Coupled THMC Processes in Geosystems  
5-7 Jul 2017 Paris (France)

### **Studying overpressure and stress heterogeneity above a deep geothermal reservoir: a multi-physics rock mechanical approach**

*R. Seithel<sup>1</sup>, M. Peters<sup>2</sup>, M. Lesueur<sup>3</sup>, Th. Kohl<sup>4</sup>*

*Keywords: multi-physics approach, geothermal reservoirs, stress heterogeneity*

Highly-pressured reservoir sections, local stress concentration or a rotated stress field may initiate substantial problems during drilling or reservoir exploitation. Increasing geothermal utilization in the Molasse basin area in Germany is faced with such deep-seated reservoir sections related problems. In several wells, radial fluid-flow systems are interpreted as highly porous reservoir sections. However, in nearby wells a combination of linear fluid-flow, local stress heterogeneities and structural geology give hints to a fault dominated reservoir (Seithel et al. 2015). Due to missing knowledge of the stress magnitude, stress orientation and their coupling to reservoir response, we will present a THMC-model of critical formations and geothermal reservoir targets nearby faults. The model is located in the south of Munich and covers an area (30 x 30 km) where several geothermal wells are constructed. The wedge-shaped foreland basin, Tertiary sediments, subparallel fault architecture and the stress field are in direct response to Alpine tectonics.

In depth, the model is subdivided into five geomechanical layers of Tertiary consolidated sand and gravel, Tertiary clayish marl, Tertiary / Lithothamnium limestone, Jurassic / Malm limestone and basement rocks. In order to implement the complex geological structure, an automatic export of lithology, fault and borehole data (e.g. from Petrel) into a FE mesh is used. We will present a reservoir-scale model that considers thermo-mechanic effects and analyze their influence on reservoir deformation, fluid flow and stability. To date, we use REDBACK (<https://github.com/pou036/redback>), a MOOSE-based application that is developed to model multi-physics RockMechanics with Dissipative feedback in a tightly coupled manner (Poulet et al. 2016).

One of the main objectives here is to create a geomechanical reservoir model in a thermo-mechanical manner in order to understand the coupling of reservoir heterogeneities and stress distributions. For this approach, stress analyses of wellbore data and laboratory tests will help to calibrate a reliable model. New insights to the mechanical behavior of deep-seated rock mass are needed for the understanding of reservoir response during development and production.

---

<sup>1</sup> Karlsruhe Institute of Technology (KIT), Adenauerring 20b, 76131, Karlsruhe, Germany, [robin.seithel@kit.edu](mailto:robin.seithel@kit.edu)

<sup>2</sup> Karlsruhe Institute of Technology (KIT), Adenauerring 20b, 76131, Karlsruhe, Germany

<sup>3</sup> School of Petroleum Engineering, The University of New South Wales, Kensington, New South Wales, Australia

<sup>4</sup> Karlsruhe Institute of Technology (KIT), Adenauerring 20b, 76131, Karlsruhe, Germany

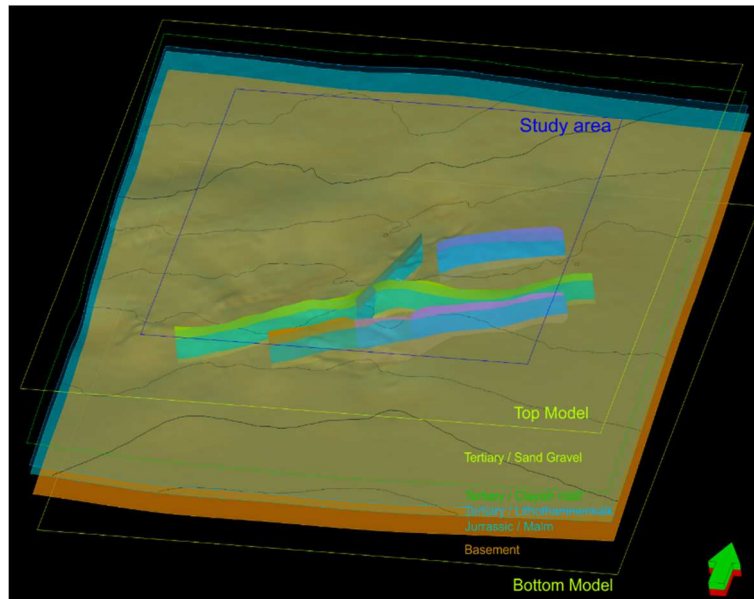

Figure 1.3D-view of the geological model with simple fault structures. Model dimension is 30 x 30 km (yellow boundary) and study area 20 x 20 km. Top model is at -1,300 m NN and bottom model at - 5,000 m NN.

## References

- Poulet, T.; Paesold, M.; Veveakis, M. (2016), Multi-Physics Modelling of Fault Mechanics Using REDBACK. A Parallel Open-Source Simulator for Tightly Coupled Problems. *Rock Mechanics and Rock Engineering*. doi: 10.1007/s00603-016-0927-y.
- Seithel, R.; Steiner, U.; Müller, B.I.R.; Hecht, Ch.; Kohl, T. (2015), Local stress anomaly in the Bavarian Molasse Basin, *Geothermal Energy* 3(1), p.77. doi:10.1186/s40517-014-0023-z



## GeoProc2017

6th International Conference on Coupled THMC Processes in Geosystems  
5-7 Jul 2017 Paris (France)

### THM Behavior of a Fluid Inclusion

A.P.S. Selvadurai<sup>1</sup>, M. Najari<sup>2</sup>

*Keywords: Thermo-poroelasticity, fluid-filled cavity, thermally-induced fluid pressures, experiments, computational simulations*

The theory of classical poroelasticity developed by Biot (1941) is the most successful multi-physical theory that can be used to examine the coupled processes of mechanical deformations and fluid flow in competent geologic media with an elastic skeletal response. Extensive reviews and documentations of the theory are given by Selvadurai (1996, 2007) and Cheng (2015), and, with suitable analytical studies classical poroelasticity has provided a computational basis for the application of the fundamental concepts to an extensive range of problems in materials engineering and the geosciences. The need for extending the scope of Biot's approach to include thermal effects largely stems from the possible application of thermo-poroelasticity to the study of problems in deep geologic disposal of heat-emitting nuclear fuel waste, geothermal energy extraction, thermal stimulation during oil extraction and the geologic sequestration of greenhouse gases in fluidized forms. In these application areas, the multi-physics processes introduce couplings that can be influenced by the dominant processes. In the context of geologic settings that are considered suitable for disposal of heat emitting nuclear fuel waste, it is generally understood that the mechanical deformations can be influenced by temperature and pore fluid pressure and the fluid pressure can be influenced by the mechanical deformations and temperature. With regard to the temperature field, it is generally assumed that the mechanical deformations of the porous skeleton and the flow processes restricts the heat transfer to pure heat conduction. This implies THM processes where the Peclet Number is less than unity. This assumption is justified by the fact that if uncontrolled fluid flow takes place in a potential setting, the geologic formation is less likely to satisfy the stringent constraints required for long term storage of heat emitting nuclear fuel waste.

The study of thermo-poroelasticity and its application to geoenvironmental problems associated with the development of strategies for deep geologic disposal of heat emitting nuclear waste, in Canada in particular, is highlighted in the articles by Selvadurai and Nguyen (1995, 1996), Nguyen et al. (1995), Najari and Selvadurai (2014) and Selvadurai et al. (2015) and an extensive account of other advances is given in a recent volume by Selvadurai and Suvorov (2016). The studies by Selvadurai and Suvorov (2012, 2014) also provide the analytical basis for the validation of computational approaches for the modelling of THM processes in fluid saturated porous media with predominantly conductive heat transfer. The governing system of weakly coupled partial differential equations can be written in the form

<sup>1</sup> McGill University, patrick.selvadurai@mcgill.ca

<sup>2</sup> McGill University, meysam.najari@mail.mcgill.ca

$$(K_D + \frac{G_D}{3})\nabla(\nabla \cdot \mathbf{u}) + G_D \nabla^2 \mathbf{u} - \alpha \nabla p - K_D \beta_s \nabla T = \mathbf{0} \quad (1)$$

$$S \frac{\partial p}{\partial t} + \nabla \cdot \left[ -\frac{\mathbf{K}}{\mu(T)} \nabla p \right] + \alpha \frac{\partial(\nabla \cdot \mathbf{u})}{\partial t} - [n\beta_f(T) + (\alpha - n)\beta_s] \frac{\partial T}{\partial t} = 0 \quad (2)$$

$$c_p^*(T) \frac{\partial T}{\partial t} - k_c^* \nabla^2 T = 0 \quad (3)$$

where  $\mathbf{u}(\mathbf{x}, t)$  is the displacement vector,  $p(\mathbf{x}, t)$  is the pore fluid pressure,  $T(\mathbf{x}, t)$  is the temperature,  $\mathbf{x}$  is the position vector and  $t$  is time. The parameters encountered in the modelling are described in the articles cited previously. In this paper, we apply the theory governed by (1) to (3) to examine the THM response of a fluid filled cavity partially drilled in a cylindrical sample of an argillaceous rock that is heated on the cylindrical surface. A computational approach is used to develop the time history of the development of fluid pressure within the cavity (Figure 1).

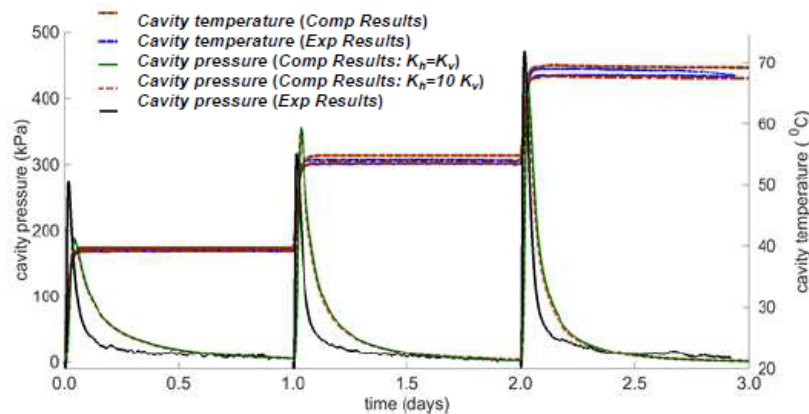

Figure 1. The results of the THM tests performed on sample of the Cobourg Limestone

## References

- Biot, M.A. (1941), General theory of three-dimensional consolidation, *J. Appl. Phys.*, 12, 155-164.
- Cheng, A.H.-D. (2015), *Poroelasticity*, Springer Verlag, Berlin.
- Najari, M. and A.P.S. Selvadurai (2014), Thermo-hydro-mechanical response of granite to temperature changes, *Env. Earth Sci.*, 72, 189–198.
- Nguyen, T.S. and A.P.S. Selvadurai (1995), Coupled thermomechanical-hydrological behaviour of sparsely fractured rock: Implications for nuclear fuel waste disposal, *Int. J. Rock Mech. Min. Sci.*, 32, 465–479.
- Selvadurai, A.P.S (Ed.) (1996) *Mechanics of Poroelastic Media*, Kluwer Acad. Publ., The Netherlands.
- Selvadurai, A.P.S. (2007), The analytical method in geomechanics, *Appl. Mech Rev.*, 60, 87-106.
- Selvadurai, A.P.S. and T.S. Nguyen (1995), Computational modeling of isothermal consolidation of fractured porous media, *Comp. Geotech.*, 17, 39–73.
- Selvadurai, A.P.S. and T.S. Nguyen (1996), Scoping analyses of the coupled thermal-hydrological-mechanical behaviour of the rock mass around a nuclear fuel waste repository, *Engng. Geol.*, 47, 379-400.
- Selvadurai, A.P.S. and A.P. Suvorov (2012), Boundary heating of poroelastic and poro-elasto-plastic spheres, *Proc. Roy. Soc. A Math. Phys.*, 468, 2779–2806, doi:10.1098/rspa.2012.0035.
- Selvadurai, A.P.S. and A.P. Suvorov (2014), Thermo-poromechanics of a fluid-filled cavity in a fluid-saturated porous geomaterial, *Proc. Roy. Soc. A Math. Phys.*, 470, 20130634, doi:10.1098/rspa.2013.0634.
- Selvadurai, A.P.S. and A.P. Suvorov (2016), *Thermo-Poroelasticity and Geomechanics*, Cambridge University Press, Cambridge.
- Selvadurai, A.P.S., A.P. Suvorov, and P.A. Selvadurai (2015), Thermo-hydro-mechanical processes in fractured rock formations during a glacial advance, *Geosci. Model Dev.*, 8, 2167–2185.





## GeoProc2017

6th International Conference on Coupled THMC Processes in Geosystems  
5-7 Jul 2017 Paris (France)

### A coupled RBSM-DFN modeling of hydraulic fracturing

Chi Yao<sup>1</sup>, Qinghui Jiang<sup>2</sup>, Jianfu Shao<sup>3</sup>, Chuangbing Zhou<sup>4</sup>

*Keywords: hydraulic fracturing, Hydro-mechanical coupling, RBSM*

A numerical model coupling the extended rigid block spring method (RBSM) and the discrete fracture network model (DFN) is proposed to study the hydraulic fracturing process in cohesive brittle rocks. The interaction between fluid pressure and mechanical response is described by Biot's theory. In this coupling model, the intact porous rock is first discretized by an assembly of rigid and impermeable blocks according to the Voronoi diagram. Fluid flow takes place in interfaces between blocks, which constitute a "fracture network". The extended RBSM method [Yao, 2015], in which both tensile and shear failure are considered, is used to describe mechanical behaviors of rocks such as elastic deformation, crack propagation and damage subjected to loading. The macroscopic mechanical behavior is related to the deformation and failure of interfaces between blocks. A DFN model, which could produce the same macroscopic hydraulic conductivity as the intact rock with an equivalent "fracture network" [Yao, 2015], is developed to simulate the transient fluid flow process. The verification of the flow model is demonstrated by an analytical solution to a one-dimensional transient flow problem. And the verification of the hydro-mechanical coupling procedure is demonstrated by an analytical solution to elastic response of a thick walled cylinder subjected to inner fluid pressure [Grassl, 2015]. The coupling model is then used to simulate the process of hydraulic fracturing in a pre-cracked rock mass illustrated in Figure 1. The fluid pressure in the pre-crack holds constant as 20MPa during the whole process. The progressive fracturing process is well produced. Effects of confining pressure on fracturing process is investigated by gradually increasing the vertical confining stress. It is found that as vertical stress increases, the depth hydraulic fracture reaches gets larger and the fracture pattern turns to be more symmetrical.

---

<sup>1</sup> School of Civil Engineering and Architecture, Nanchang University, chi.yao@ncu.edu.cn

<sup>2</sup> School of Civil Engineering and Architecture, Nanchang University, jqh1972@ncu.edu.cn

<sup>3</sup> Laboratory of Mechanics of Lille, University of Lille, Cité scientifique, jian-fu.shao@polytech-lille.fr

<sup>4</sup> School of Civil Engineering and Architecture, Nanchang University, cbzhou@whu.edu.cn

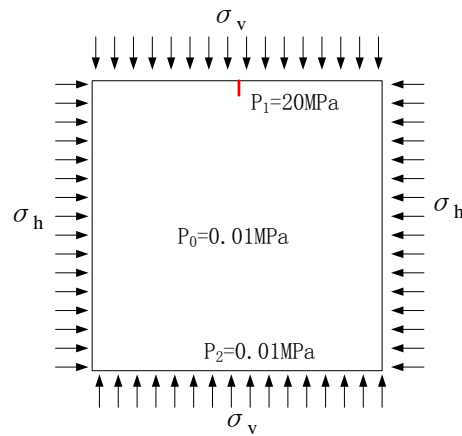

Figure 1. Boundary condition for simulation of hydraulic fracturing.

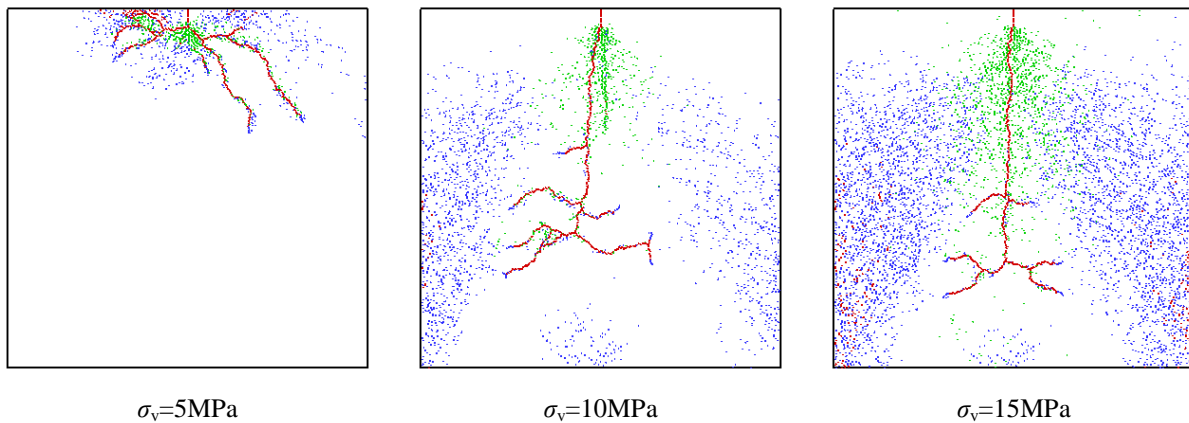

Figure 2. Hydro-fracture pattern for different vertical stresses when the horizontal stress remains constant as 5MPa (red-large tensile crack; blue-small tensile crack; green-shear crack)

## References

- C Yao, Q Jiang and J Shao: Numerical simulation of damage and failure in brittle rocks using a modified rigid block spring method. *Computers and Geotechnics*, 64 (2015), 48–60.
- C Yao, Q Jiang and J Shao: A Numerical Analysis of Permeability Evolution in Rocks with Multiple Fractures. *Transport in Porous Media*, 108 (2015), 289–311.
- P Grassl, C Fahy, D Gallipoli and S Wheeler: On a 2D hydro-mechanical lattice approach for modelling hydraulic fracture. *Journal of the Mechanics and Physics of Solids*, 75 (2015), 104–118.



## GeoProc2017

6th International Conference on Coupled THMC Processes in Geosystems  
5-7 Jul 2017 Paris (France)

### **Microstructure and Thermo-Hydro-Mechanical effects as an explanation of rate dependency during seismic slip**

*I. Stefanou<sup>1</sup>, H. Rattetz<sup>1</sup>, J. Sulem<sup>1</sup>*

*Keywords: Cosserat, viscosity, fault mechanics, THM couplings, earthquakes*

Rapid shear tests of granulated fault gouges show pronounced rate-dependency. For this reason rate-dependent constitutive laws are frequently used for describing fault friction (e.g. Dieterich, 1979).

Here we propose a micromechanical, physics-based continuum approach by considering the characteristic size of the microstructure and the thermal- and pore-pressure-diffusion mechanisms that take place in the fault gouge during rapid shearing. It is shown that even for a rate-independent constitutive law, the macroscopic behavior of the system is rate-dependent, due to the competition of the characteristic lengths and time scales introduced indirectly by the microstructure and the thermal and hydraulic diffusivities.

Cosserat continuum theory is used for upscaling the characteristic size of the microstructure of a granulated fault to the macroscale. Cosserat continuum is the simplest of the general class of micromorphic continua, which are capable of transferring at the macroscale several intrinsic lengths of the microstructure. Cauchy continuum is a special case of the Cosserat continuum, when setting to zero the aforementioned internal lengths.

The analysis starts by studying analytically a simple example of adiabatic shearing of a rock layer under constant shear stress. The purpose of this example is to juxtapose a rate-dependent Cauchy continuum with a rate-independent Cosserat continuum under thermal softening. The two different modeling frameworks are compared regarding the condition for strain localization. It is shown that the conditions for shear band triggering have similar mathematical forms, even though the starting point is different from a physical point of view in each modeling framework. In particular, we find that the rolling stiffness of the Cosserat continuum stabilizes the system in the same way that viscosity and thermal diffusion do for the rate dependent Cauchy model (Sulem and Stefanou, 2016) leading to a shear band of finite thickness.

At a second stage the linear, angular, mass and energy balance equations are written in their full form and a fully coupled Thermo-Hydro-Mechanical (THM) Cosserat continuum model is derived (Sulem et al., 2011). The equations are then integrated numerically

---

<sup>1</sup> Laboratoire Navier-CERMES, Ecole des Ponts Paris Tech, IFSTTAR, CNRS, Université Paris-Est, [ioannis.stefanou@enpc.fr](mailto:ioannis.stefanou@enpc.fr), [hadrien.rattetz@enpc.fr](mailto:hadrien.rattetz@enpc.fr), [jean.sulem@enpc.fr](mailto:jean.sulem@enpc.fr)

using an implicit solver (Poulet et al., 2016) and the shear-strain behavior of the gouge layer is explored for different applied velocities.

It is shown that both the softening behavior and the shear band thickness depend on the applied velocity, despite the fact that the constitutive description of the material was considered rate-independent (Figure 1, left). In other words, rate-dependency appears naturally as a macroscopic result. Moreover the size of the microstructure, which here is identified with the grain size of the fault gouge ( $D_{50}$ ), plays an important role in the slope of the softening branch of the shear stress-strain response curve (Figure 2, right) and consequently in the transition from aseismic to seismic slip (see Scholz 2002).

The proposed model can be further extended to take into account rate-effects at the grain contacts towards more realistic simulations. Moreover, further theoretical developments that account for strong chemo-thermo-poro-mechanical couplings (e.g. Veveakis et al. 2013, Stefanou and Sulem, 2014) show that shear strain localization can be further enhanced in faults due to chemical effects that influence directly or indirectly the energy budget of the system, stability and the transition from aseismic to seismic slip.

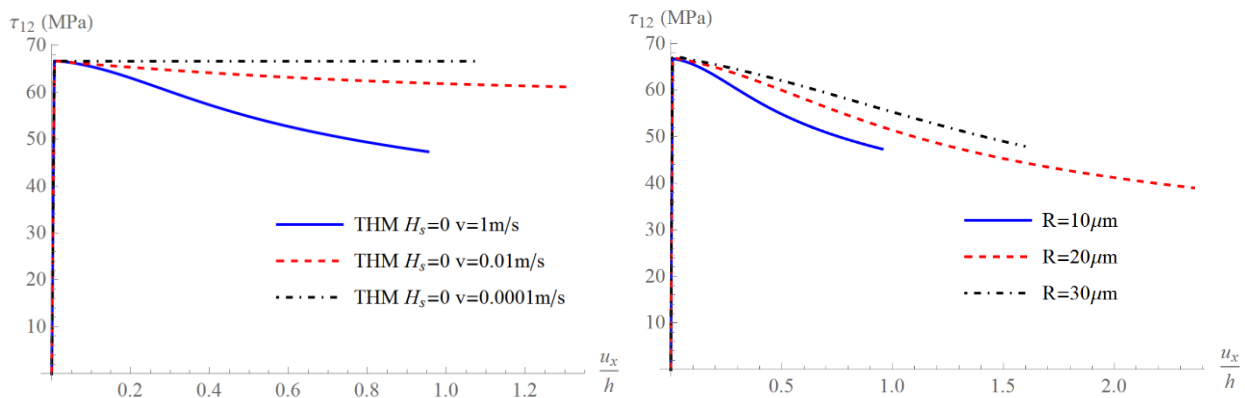

Figure 1. Left: Shear-strain response of a fault gouge under different constant applied shear velocities and constant grain size ( $R=10\mu\text{m}$ ), Right: Shear-strain response of a fault gouge for different grain sizes under constant applied shear velocity ( $v=1\text{m/s}$ ).

## References

- Dieterich, J. H. (1979). Modeling of rock friction: 1. Experimental results and constitutive equations. *Journal of Geophysical Research*, 84(B5), 2161.
- Veveakis, E., Alevizos, S., & Vardoulakis, I. (2010). Chemical reaction capping of thermal instabilities during shear of frictional faults. *Journal of the Mechanics and Physics of Solids*, 58(9), 1175–1194.
- Sulem, J., & Stefanou, I. (2016). Thermal and chemical effects in shear and compaction bands. *Geomechanics for Energy and the Environment*, 6, 4–21.
- Sulem, J., Stefanou, I., & Veveakis, E. (2011). Stability analysis of undrained adiabatic shearing of a rock layer with Cosserat microstructure. *Granular Matter*, 13(3), 261–268.
- Poulet, T., Paesold, M., & Veveakis, E. (2016). Multi-Physics Modelling of Fault Mechanics Using REDBACK: A Parallel Open-Source Simulator for Tightly Coupled Problems. *Rock Mechanics and Rock Engineering*, pp. 1–17.
- Scholz, C. H. (2002). *The mechanics of earthquakes and faulting* (Second). Cambridge.
- Veveakis, E., Stefanou, I., & Sulem, J. (2013). Failure in shear bands for granular materials: thermo-hydro-chemo-mechanical effects. *Géotechnique Letters*, 3(April-June), 31–36.
- Stefanou, I., & Sulem, J. (2014). Chemically induced compaction bands: Triggering conditions and band thickness. *Journal of Geophysical Research: Solid Earth*, 119(2), 880–899.



## GeoProc2017

6th International Conference on Coupled THMC Processes in Geosystems  
5-7 Jul 2017 Paris (France)

### Strain localization in submerged slopes due to rapid sedimentation

A. Stöcklin<sup>1</sup>, B. Friedli<sup>2</sup>, A.M. Puzrin<sup>3</sup>

*Keywords: Overpressure, Hydromechanical coupling, Sedimentation, Submarine landslides*

Submarine slope failures are commonly observed in regions where sedimentation rates are high. These mass movements can be extremely large and occur at very low slope angles, suggesting that pre-conditioning factors, such as fluid overpressure (*i.e.*, pressure in excess of hydrostatic) and flow are important controls. In active sedimentary regions, fluid pressure in excess of hydrostatic can arise from rapid accumulation of sediments outpacing the dissipation of excess pore-water pressure. The present work is focused on modeling this coupled hydro-mechanical process in slopes and investigating its influence on slope stability and failure mechanisms, taking into account shear-induced excess pore water pressures.

Modeling sediment accumulation in basins has been subject to many research efforts, addressing the need of the oil industry faced with the challenge of drilling in overpressured basins. Gibson [1958] first developed an analytical solution for the one-dimensional consolidation of a clay layer increasing in thickness with time, assuming linear soil behavior. Later more generalized solutions and applications followed, based on finite-difference and finite element approaches [*e.g.*, *Audet and Fowler, 1992; Dugan and Flemings, 2000*]. In contrast to most of these investigations, this study deals with the implications of fast sediment accumulation on sloping ground. Fast deposition of low permeability soils leads to mean effective stresses and gravitational shear stresses no longer increasing at the same rate with respect to depth causing partially undrained shearing of the soil. This activates an additional source for excess pore-water pressures due to the tendency of loose clays to contract during shearing.

We model this non-linear moving boundary value problem using a coupled hydro-mechanical finite element approach. The development of overpressure is affected by a number of factors, most importantly the ratio between the sediment permeability and sedimentation rate, the shearing behavior and the non-linear evolution of compressibility and permeability with changing porosity. Both the compressibility and permeability decrease by orders of magnitude as the compaction process causes the soil to experience large volumetric strains. Geometric non-linearity has been accounted for by applying the finite strain theory.

<sup>1</sup> Institute for Geotechnical Engineering, ETH Zürich, Switzerland, andreas.stoecklin@igt.baug.ethz.ch

<sup>2</sup> Institute for Geotechnical Engineering, ETH Zürich, Switzerland, balz.friedli@igt.baug.ethz.ch

<sup>3</sup> Institute for Geotechnical Engineering, ETH Zürich, Switzerland, alexander.puzrin@igt.baug.ethz.ch

Results from a 1D infinite slope analysis are shown in Figure 1 for four different stages during the process of a constant rate sediment build-up on a rigid, impermeable, inclined base. Due to the higher permeability of sediments near the seafloor, the soil in that region is close to normally consolidated (Figures 1a and 1b), with stresses in a particular element following nearly a drained  $K_0$ -consolidation path. With increasing overburden the permeability decreases, the overpressure grows and the stress path is nearly undrained as the failure envelope is approached (Figures 1a and 1b). This leads to a shear-induced, local increase in the shear stress ratio and strain localization at a defined depth (Figures 1c and 1d).

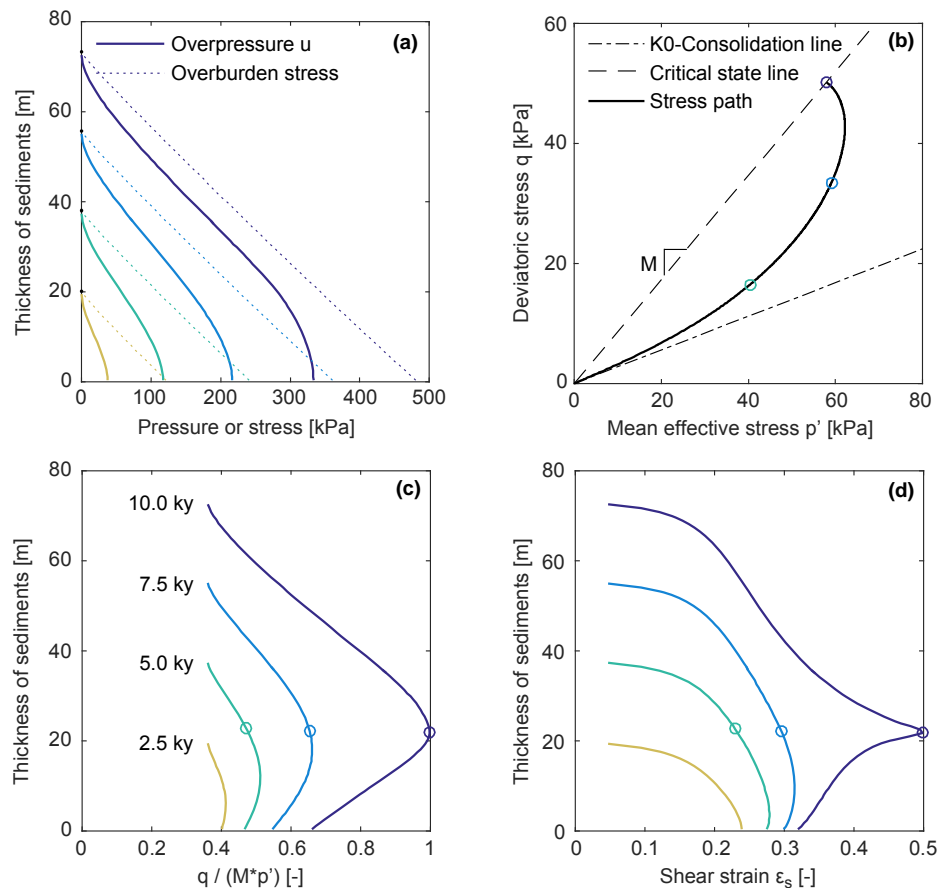

Figure 1. Results from an infinite slope sedimentation analysis at different stages showing the distribution of overpressure (a), stress ratio (c) and shear strain (d) within the soil body. In (b) the stress path is shown for the element where failure occurs (location indicated with circles)

Although sedimentation is unlikely to be the sole trigger of a landslide, the present work proves it to be an important pre-conditioning factor, in particular with respect to the critical depth of failure planes and the volume of the moving soil. The same approach can be applied to model the process of sedimentation in 2D or 3D slope geometries and may provide initial conditions for subsequent predictive slope stability analysis.

## References

- Audet, D.M., and A.C. Fowler (1992), A mathematical model for compaction in sedimentary basins, *Geophysical Journal International*, 110(3), 577–590, doi: 10.1111/j.1365-246X.1992.tb02093.x.
- Dugan, B., and P.B. Flemings (2000), Overpressure and Fluid Flow in the New Jersey Continental Slope: Implications for Slope Failure and Cold Seeps, *Science*, 289(5477), 288–291, doi: 10.1126/science.289.5477.288.
- Gibson, R.E. (1958), The Progress of Consolidation in a Clay Layer Increasing in Thickness with Time, *Géotechnique*, 8(4), 171–182, doi: 10.1680/geot.1958.8.4.171.



## GeoProc2017

6th International Conference on Coupled THMC Processes in Geosystems  
5-7 Jul 2017 Paris (France)

### Multiphysics couplings and strain localization in fault zones

*J.Sulem<sup>1</sup>, I.Stefanou<sup>1</sup>, H.Rattez<sup>1</sup>*

*Keywords: THM couplings, fault mechanics, strain localization, microstructure*

Localized deformation in the form of shear bands is one of the most common features of failure in geomaterials. Shear zones appear at all scales from tens of kilometres for large crustal faults, which accommodate tectonic deformation of the Earth's crust, to few microns for slip zones observed inside faults core. These very thin localized zones can sometimes accommodate tens of kilometres of slip. In recent years, several drilling programs in active faults have highlighted the importance of physico-chemical processes involved in the nucleation of seismic slip (e.g. Niemeijer et al., 2012).

Although strain localization in the form of shear band formation can occur with negative or positive rate of strain hardening, softening behaviour definitely favours shear banding (Rudnicki & Rice, 1975, Vardoulakis & Sulem, 1995). This softening behaviour may correspond to a mechanical degradation of the rock properties (microcracking, grain crushing and grain size reduction...), but various other physical processes can also be responsible for it. The effect of an infiltrated pore fluid which interacts with a rock mass can lead to a hardening or softening behaviour depending on the volumetric response of the rock (dilatant or contractant). The fast heating of a saturated geomaterial leads to pore-fluid pressurization due to the discrepancy between the thermal expansion of water and solid grains. Thermal pressurization is a softening mechanism as it results in a decrease of the effective mean stress and thus of the shear strength (Platt et al., 2014, Sulem & Stefanou, 2016). Chemical reactions such as dissolution/ precipitation, mineral transformation at high temperature (dehydration of minerals, decomposition of carbonates, ...) affect the solid phase and the porosity of the rock and can induce a positive feedback in the progressive mechanical degradation. Thermal decomposition of minerals at large rise in temperature liberates a fluid product phase and enhances the generation of additional pore pressure excess (Sulem & Famin, 2009, Brantut & Sulem, 2012). It can form a mineral assemblage stronger (reaction hardening) or weaker (reaction weakening) than the original material. On the other hand, mechanical damage increases the reaction surface between a reactive fluid and the solid and enhances dissolution and further material weakening (Hu & Hueckel, 2007, Stefanou & Sulem, 2014).

Linear stability analysis allows to study the occurrence of localized deformation in a mechanical system with multi-physical couplings. It is of particular interest to determine the dominant wave length of the instability (wave length corresponding the greatest

---

<sup>1</sup> Laboratoire Navier-CERMES, Ecole des Ponts Paris Tech, IFSTTAR, CNRS, Université Paris-Est, [jean.sulem@enpc.fr](mailto:jean.sulem@enpc.fr), [ioannis.stefanou@enpc.fr](mailto:ioannis.stefanou@enpc.fr), [hadrien.rattez@enpc.fr](mailto:hadrien.rattez@enpc.fr).

positive and finite growth rate of the instability). The close relation between the selected wave length and the width of the localized zone can be assessed from a numerical integration of the non-linear system of governing equations in the post-localization regime (Rattez et al., 2017). However, wave length selection can only be obtained if a material length is introduced in the constitutive equations (e.g. higher order continuum) or if rate-dependency is considered. This reflects a well-known drawback of classical continuum theories as applied to strain localization analyses performed for rate-independent materials which lead to unphysical infinitesimally narrow localized zones.

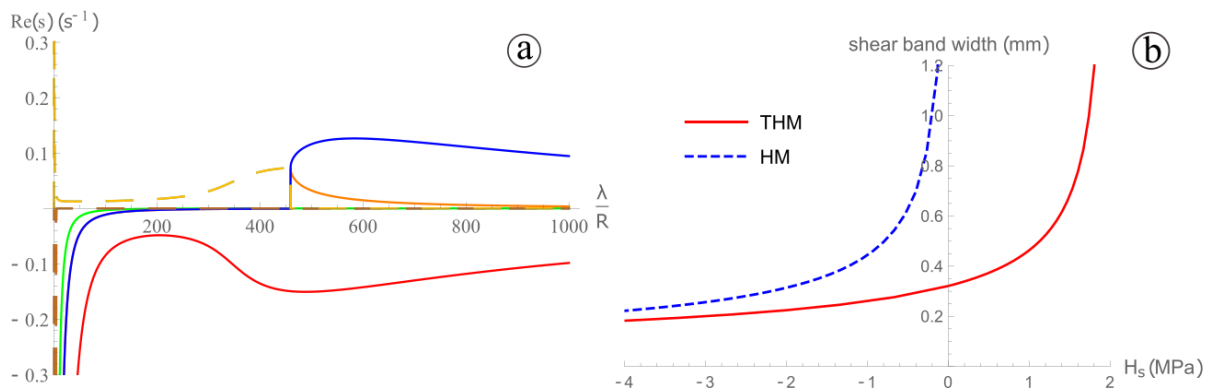

Figure 1. (a) Real part of the exponential growth  $s$  of the perturbation as a function of the wavelength ( $\lambda$ ) of the perturbation for a zero dilatancy coefficient and hardening modulus 1.5MPa. The dashed lines represent  $s$  that presents a nonzero imaginary part. (b) Thickness of the shear band as a function of the hardening modulus considering THM couplings or the Hydro-Mechanical (HM) couplings only.

Different examples of multi-physical couplings active in fault zones are shown emphasizing the coupled effect of the microstructure and diffusion processes in the control of the localized zone thickness.

## References

- Brantut, N., & Sulem, J. (2012). Strain Localization and Slip Instability in a Strain-Rate Hardening, Chemically Weakening Material. *Journal of Applied Mechanics*, 79(3).
- Hu, L.-B., & Hueckel, T. (2007). Creep of saturated materials as a chemically enhanced rate-dependent damage process, 31, 1537–1565.
- Niemeijer, A. R., Di Toro, G., Griffith, A. W., Bistacchi, A., Smith, S. A. F., & Nielsen, S. (2012). Inferring earthquake physics and chemistry using an integrated field and laboratory approach. *Journal of Structural Geology*, 39, 2–36.
- Platt, J. D., Rudnicki, J. W., & Rice, J. R. (2014). Stability and localization of rapid shear in fluid-saturated fault gouge: 2. Localized zone width and strength evolution. *Journal of Geophysical Research: Solid Earth*, 119(5), 4334–4359.
- Rattez, H., Stefanou, I., Sulem, J., Vevealis, M., Poulet, T. (2017). Localisation of deformation for shearing of a fault gouge with cosserat microstructure and different couplings. In: *Bifurcation and Degradation of Geomaterials with Engineering Applications*. (E. Papamichos, P. Papanastasiou, E. Pasternak, & A. Dyskin, Eds.). Springer.
- Rice, J. R., Rudnicki, J. W., & Platt, J. D. (2014). Stability and localization of rapid shear in fluid-saturated fault gouge: 1. Linearized stability analysis. *Journal of Geophysical Research: Solid Earth*, 119(5), 4311–4333.
- Rudnicki, J. W., & Rice, J. R. (1975). Conditions for the localization of deformation in pressure-sensitive dilatant materials. *Journal of the Mechanics and Physics of Solids*, 23, 371–394.
- Stefanou, I., & Sulem, J. (2014). Chemically induced compaction bands: Triggering conditions and band thickness. *Journal of Geophysical Research: Solid Earth*, 119(2), 880–899.
- Sulem, J., & Famin, V. (2009). Thermal decomposition of carbonates in fault zones: Slip-weakening and temperature-limiting effects. *Journal of Geophysical Research*, 114(B3), 1–14.
- Sulem, J., & Stefanou, I. (2016). Thermal and chemical effects in shear and compaction bands. *Geomechanics for Energy and the Environment*, 6, 4–21.
- Vardoulakis, I., & Sulem, J. (1995). *Bifurcation analysis in geomechanics*, Taylor & Francis.





## GeoProc2017

6th International Conference on Coupled THMC Processes in Geosystems  
5-7 Jul 2017 Paris (France)

### **Experimental investigation of pore pressure propagation around the borehole during drilling in gas shale formations**

*Ma Tianshou<sup>1</sup>, Chen Ping<sup>2</sup>*

*Keywords: Gas shale; Pore pressure; Pressure propagation; Wellbore stability*

The most effective technologies for exploitation of shale gas are horizontal well drilling and multi-stage fracturing. However, to drill a long-distance horizontal borehole in the unstable shale rock formation, the borehole collapse problems are often encountered, which makes it become a new challenge for drilling engineering. Once the borehole collapse problem occurs, it may cause or induce some very serious downhole problems or drilling accidents, such as the induced wellbore collapse, induced lost circulation, induced blowout, induced pipe-sticking, and etc. In fact, due to gas shale rocks are usually characterized by tight matrix, rich in clay minerals, well-developed bedding planes and micro-fissures, which makes it highly water-sensitive and strong anisotropic. The propagation of pore pressure occurs when exposure to drilling mud, and the driving forces include hydraulic pressure, chemical osmotic pressure, thermal and electrical potential gradients, but the thermal and electrical potential gradients are usually ignored. Therefore, the most important factors of wellbore instability for horizontal drilling in shale gas reservoirs are mainly induced by the mechanical-chemical (M-C) coupling. The difficulties of the M-C coupling may be the quantitative description of mechanical effects caused by chemical reaction. Currently, only three kinds of theoretical methods are commonly used: the thermoelastic analogy method, the equilibrium thermodynamic theory, and the non-equilibrium thermodynamic theory. These methods treat the chemical reaction as an additional pore pressure to predict the approximate mechanical effects. However, the theoretical and experimental investigations only can be utilized for isotropic shale formations, but cannot be applied for anisotropic shale formations.

In this paper, a new experimental apparatus was designed to simulate downhole drilling conditions and test the pore pressure propagation. As shown in Figure 1, the pore pressure can be measured in three different cross sections along the axial direction of the specimen, and three pressure sensors are installed in each section with an interval of 120°. The pressure propagation tests were conducted for anisotropic LMX shale rock in different directions, both in parallel and perpendicular directions, by using this novel experimental apparatus. An inversion method was also proposed to explain the testing results based on the non-equilibrium thermodynamic theory and finite difference

<sup>1</sup> State Key Laboratory of Oil & Gas Reservoir Geology and Exploitation, Southwest Petroleum University, matianshou@126.com

<sup>2</sup> State Key Laboratory of Oil & Gas Reservoir Geology and Exploitation, Southwest Petroleum University, chenping@swpu.edu.cn

method. The ion diffusion coefficient, hydraulic diffusion coefficient and membrane efficiency along different directions were obtained and contrasted. The results indicated that the simulated results are overall consistent with the test results, the maximum relative error is about 28%, and the relative error gradually decreases with time goes on (Figure 2). The pore pressure increases with time, the increasing rate of pore pressure in the upper end is obviously higher than the lower end due to the influence of chemical osmotic pressure. The heterogeneity and anisotropy of pressure propagation are very strong for LMX shale. The main reasons that affect the pore pressure were also discussed.

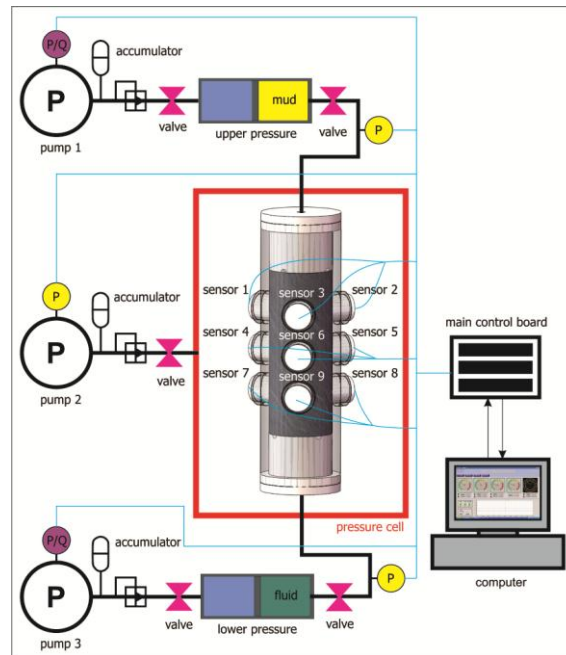

Figure 1. The new experimental apparatus of pore pressure propagation testing.

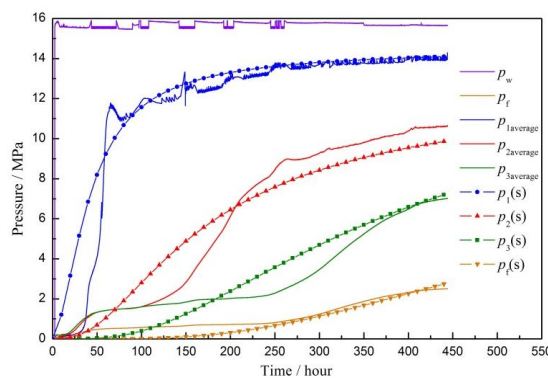

Figure 2. A typical test and explained results of pore pressure propagation.

## References

- Mody, F.K, and Hale, A.H. (1993), Borehole-stability model to couple the mechanics and chemistry of drilling-fluid/shale interactions. *Journal of Petroleum Technology*, 45(11), 1093-1101.
- Lomba, R.F.T, Chenevert, M.E, and Sharma, M.M. (2000), The ion-selective membrane behavior of native shales. *Journal of Petroleum Science and Engineering*, 25(1/2), 9-23.
- Ma, T., and Chen, P. (2015), A wellbore stability analysis model with chemical-mechanical coupling for shale gas reservoirs. *Journal of Natural Gas Science and Engineering*, 26, 72-98.
- Ma, T., Chen, P., Wang, X., Guo, Z., and Liu, Z. (2016), Numerical method of pore pressure propagation around the borehole for shale gas reservoirs. *Acta Petrolei Sinica*, 37(4), 660-671.



## GeoProc2017

6th International Conference on Coupled THMC Processes in Geosystems  
5-7 Jul 2017 Paris (France)

### A numerical approach for simulation of shear dilation of three-dimensional fracture networks

*Eren Uçar<sup>1</sup>, Inga Berre<sup>1,2</sup>, Eirik Keilegavlen<sup>1</sup>*

*Keywords: fracture stimulation, shear-dilation, numerical methods*

Stimulation of fractures in igneous and metamorphic rocks can enhance the permeability of critically oriented fractures with orders of magnitude at pressures elevated below the minimum principal stress. Complex THMC couplings dominate the subsurface processes.

A numerical approach for modelling of shear dilation of fracture networks in a three-dimensional low-permeable matrix is developed, focusing on the hydro-mechanical coupling. The approach is based on a conceptual discrete fracture-matrix (DFM) model where the dominating fractures are modelled explicitly and surrounded by low-permeable matrix, capturing the effect of small-scale fractures on the flow. The rock matrix is assumed to be linearly elastic, while a fracture deformation model handles the frictional shear-slip and dilation of the fractures, coupled to the matrix by internal boundary conditions. Applying recently developed finite volume-type discretizations, the effect of, for example, background matrix permeability on the hydraulic stimulation of the fracture network can be investigated. See, e.g., Ucar et al. (2016) for a preliminary study for a two-dimensional geometry.

Figure 1 and Figure 2 shows, respectively, the grid and simulation results for an example study based on a simplified three-dimensional fracture network geometry.

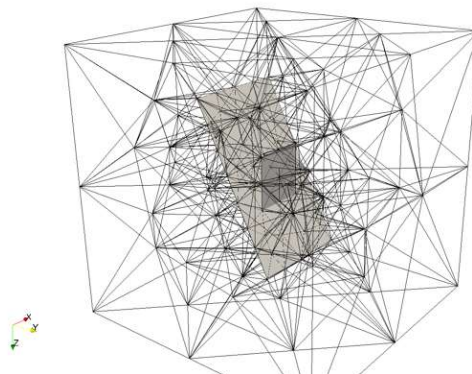

Figure 1: Grid for a domain with two intersecting fractures.

<sup>1</sup>Department of Mathematics, University of Bergen, Norway, inga.berre@uib.no

<sup>2</sup>Christian Michelsen Research, Norway

Fluid is injected in the smallest fracture, which has a fixed aperture. Shear-dilation of the larger fracture due to the elevated fluid pressure can be observed in Figure 2.

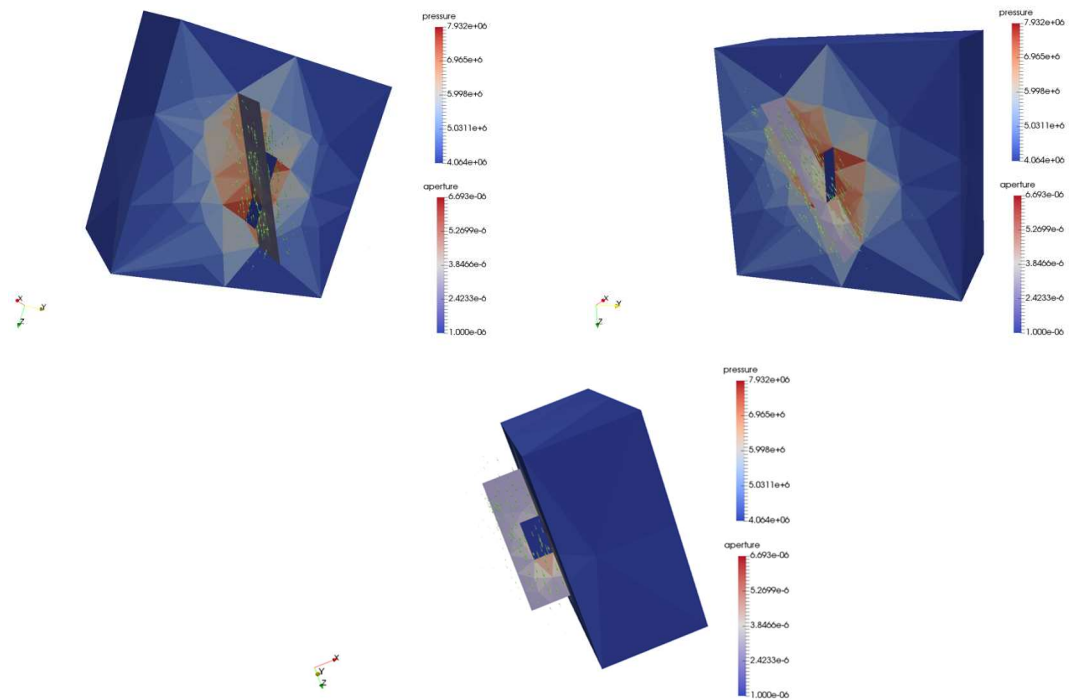

Figure 2: Numerical results shown from two different angles for a stimulation process inducing shear dilation. Pressure is shown in the matrix-part of the domain and aperture is shown in the fractures.

## References

- E. Ucar, I. Berre, E. Keilegavlen, Modeling of the Shear Dilation Based Hydraulic Stimulation in Enhanced Geothermal Systems Considering fractures in Different Scales, Proc. of the European Geothermal Congress, Strasbourg, France, 19-24 Sept., 2016.



## GeoProc2017

6th International Conference on Coupled THMC Processes in Geosystems  
5-7 Jul 2017 Paris (France)

### **An X-FEM technique for simulation of hydraulic fracturing in impervious fractured domains: numerical and experimental investigations**

*M. Vahab*<sup>1\*</sup>, *A. R. Khoei*<sup>2</sup>, *N. Khalili*<sup>3</sup>

*Keywords: hydraulic fracturing, X-FEM; multiple cracks, crack growth, frictional natural discontinuities*

A numerical/experimental approach is presented to study the hydraulic fracturing process in impermeable media containing frictional natural discontinuities. Using the X-FEM, the discontinuities are modeled independent of the FE mesh by introducing additional degrees-of-freedom. A fixed-point iterative algorithm is proposed to impose the flow condition at the injection point. The nonlinear fracturing processes occurring ahead of the hydro-fracture tip is captured by taking advantages from the cohesive crack model. The frictional contact along the faces of the natural discontinuity is modeled by using the Coulomb's plasticity. The Darcy law is adopted to model the hydro-fracture inflow, where the permeability of the fracture is determined on the basis of the well-known cubic law [1]. The hydro-mechanical coupled governing equations are solved by using a staggered Newton solution strategy. The Newton-Raphson iterative scheme is utilized in order to linearize the system of nonlinear equations. According to Zhang et al. [2], the interaction of hydro-fractures with natural discontinuities may lead to four distinguished scenarios, namely: 1) penetration of the hydro-fracture across the natural interface, 2) the hydro-fracture arrest at the natural interface, 3) the hydro-fracture diversion into the natural interface, and 4) the hydro-fracture offset (see Figure 1). The addressed scenarios are studied by means of numerical simulation, and the results are compared with experimental studies performed on real samples provided from oil reservoirs in south of Iran as depicted in Figure 2 (see [3-4]).

---

<sup>1</sup> School of Civil and Environmental Engineering, The University of New South Wales, Sydney 2052, Australia (*m.vahab@unsw.edu.au*).

<sup>2</sup> Center of Excellence in Structural and Earthquake Engineering, Department of Civil Engineering, Sharif University of Technology, P.O. Box. 11365-9313, Tehran, Iran (*arkhoei@sharif.edu*).

<sup>3</sup> School of Civil and Environmental Engineering, The University of New South Wales, Sydney 2052, Australia (*n.khalili@unsw.edu.au*).

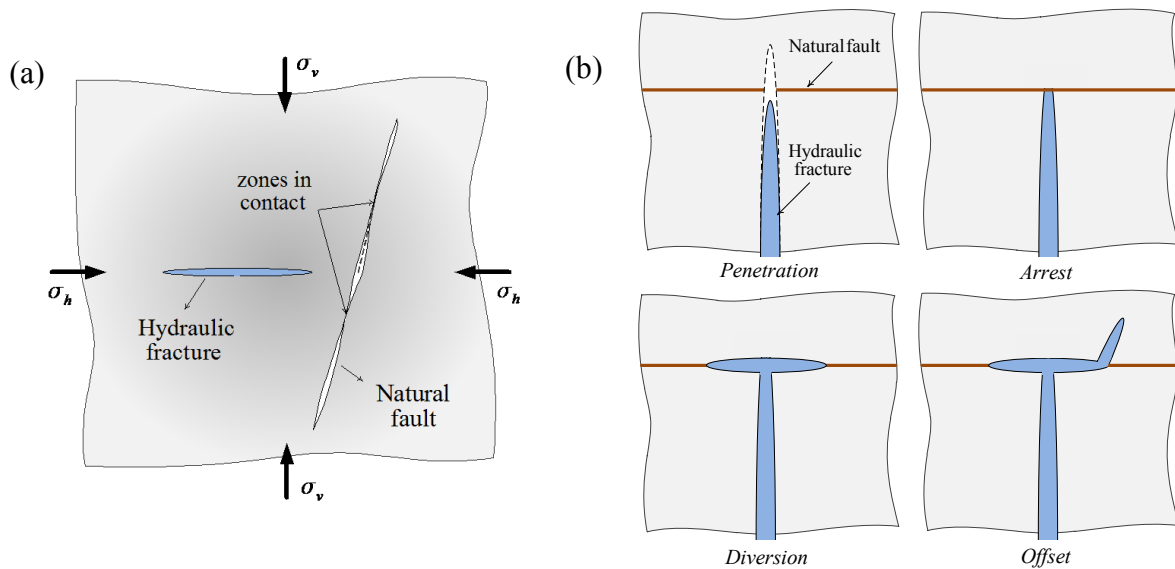

Figure 1. Hydraulic fracture evolution in fractured media; (a) interacting hydro-fracture with natural discontinuity, (b) possible interaction scenarios.

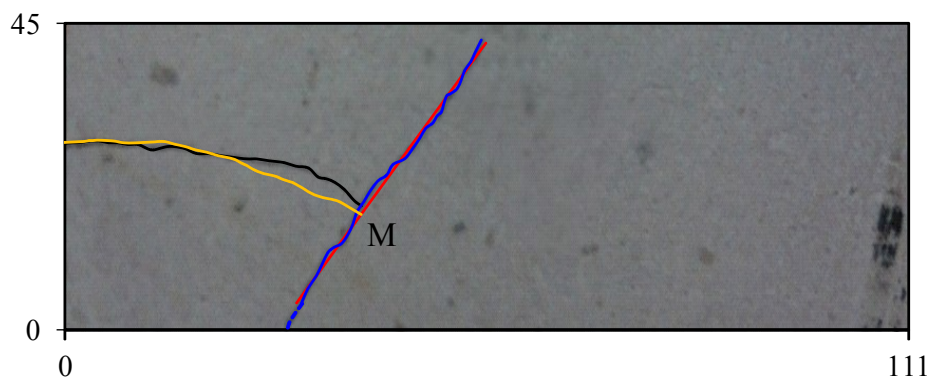

Figure 2. A comparison of the crack growth trajectory between the numerical simulation and experiment (dimensions in mm).

## References

- Detournay, E., and A.H.D. Cheng (1993), Fundamentals of poroelasticity1. *Chapter 5 in Comprehensive Rock Engineering: Principles, Practice and Projects, II*, 113-171.
- Zhang, X., R.G. Jeffrey, and M. Thiercelin (2007) Deflection and propagation of fluid-driven fractures at frictional bedding interfaces: a numerical investigation. *J. Struct. Geol.*, 29(3), 396-410.
- Khoei, A.R., M. Vahab, and M. Hirmand (2016) Modeling the interaction between fluid-driven fracture and natural fault using an enriched-FEM technique. *Int. J. Fract.*, 197(1), 1-24.
- Khoei, A.R., M. Hirmand, M. Vahab, and M. Bazargan (2015) An enriched FEM technique for modeling hydraulically driven cohesive fracture propagation in impermeable media with frictional natural faults: Numerical and experimental investigations. *Int. J. Numer. Meth. Eng.*, 104(6), 439-468.



## GeoProc2017

6th International Conference on Coupled THMC Processes in Geosystems  
5-7 Jul 2017 Paris (France)

### Impact of thermal cycles on the mobilization of shear strength for energy piles

*R. Vasilescu<sup>1</sup>, P. Kotronis<sup>2</sup>, C. Dano<sup>3</sup>, F. Collin<sup>4</sup>, P. Gotteland<sup>5</sup>*

*Keywords: energy piles, interface direct shear test, THM*

Understanding the long-term soil-structure interface behavior is particularly important for axially loaded piles. In these foundations, the frictional resistance between the pile and the soil provides one part of the pile's total capacity (shaft resistance). Regarding energy piles – double purpose structures consisting in the integration of heat exchanger pipes within the foundation – the response of the pile-soil interface is additionally influenced by daily and seasonal temperature variations. In order to assess the impact of the thermal cycles on the mobilization of shear strength, a series of direct shear tests on saturated sand-concrete interface were performed under different temperature gradients.

An interface direct shear device, equipped with a temperature control system, was used to investigate the shear behavior of the soil-concrete interface. A picture of the device and one of the container accommodating the shear box in which a concrete plate is installed, are shown in Figure 1 (a) and (b). The tested specimen is heated through a closed loop system (connected to a thermostat) that is installed under the support of the lower box, containing the structural element. The experimental campaign is divided in three parts: (i) concrete-sand direct shear tests at 13°C (constant temperature) to be used as the reference case (this temperature corresponds to the average soil temperature under 5m with respect to the ground level in France) (ii) concrete-sand direct shear test after 10 temperature cycles with a temperature amplitude of  $\Delta T = \pm 5^\circ\text{C}$ , (iii) concrete-sand direct shear test after 10 temperature cycles with a temperature amplitude of  $\Delta T = \pm 7.5^\circ\text{C}$ .

The experiments are then reproduced numerically using a 2D thermo-hydro-mechanical (THM) model with the finite element code LAGAMINE. The soil-pile behavior is modelled using 2D fully THM interface finite elements that belong to the

<sup>1</sup> Ecole Centrale de Nantes, Institut de Recherche en Génie Civil et Mécanique (GeM), 1 Rue de la Noë, F-44321, Nantes, France, andreea-roxana.vasilescu@ec-nantes.fr

<sup>2</sup> Ecole Centrale de Nantes, Institut de Recherche en Génie Civil et Mécanique (GeM), 1 Rue de la Noë, F-44321, Nantes, France, panagiotis.kotronis@ec-nantes.fr

<sup>3</sup> Université Grenoble Alpes UGA, Laboratoire 3SR, Domaine Universitaire, BP53, 38041 Grenoble, France christophe.dano@3sr-grenoble.fr

<sup>4</sup> Université de Liège, Département Géotechnique, Bât. B52/3 Institut de Mécanique et Génie civil, Quartier Polytech 1, allée de la Découverte 9, 4000 Liège 1, Belgique, F.Collin@ulg.ac.be

<sup>5</sup> Fédération Nationale des Travaux Publics, 3 rue de Berri, 75008 Paris, France, gottelandp@fntp.fr

zero thickness family and for which the contact conditions are imposed using a penalty method. These types of elements are able to reproduce the fluid flow in the interface as well as the contact/loss of contact between two solids and the shearing/sliding of the interface. The penalty coefficients were adapted to match the experimental results thus obtaining a more efficient prediction tool for the behavior of energypiles.

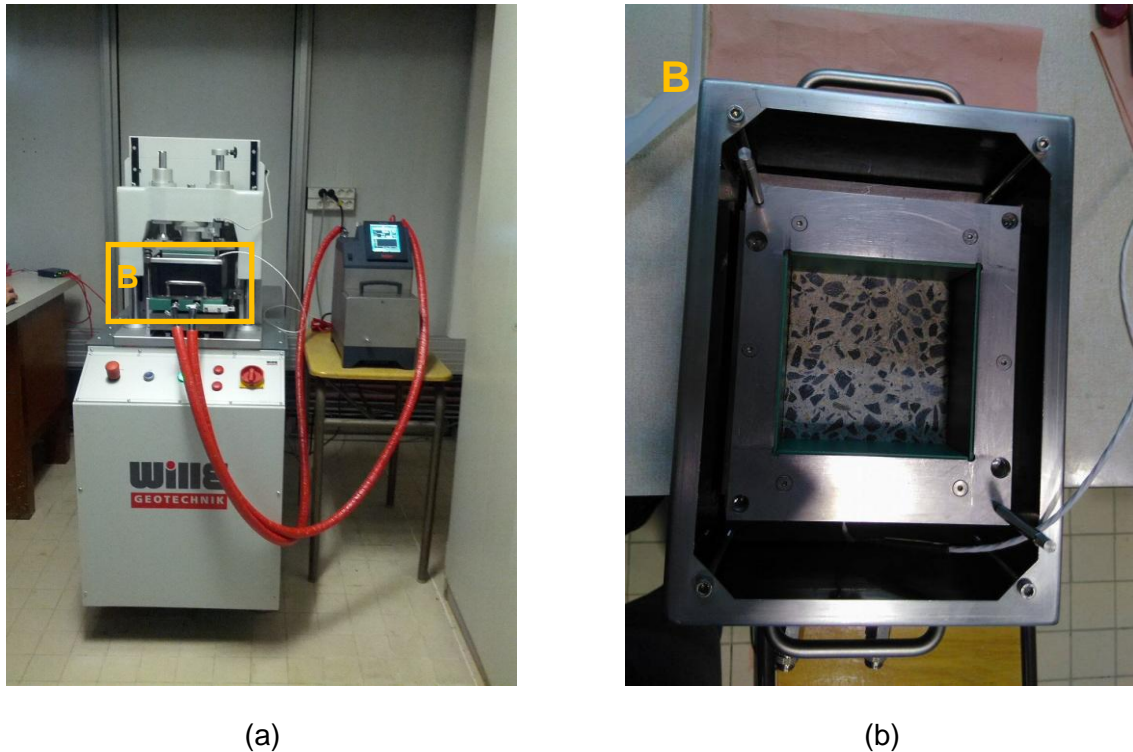

Figure 1. Interface direct shear device was adapted to incorporate the thermal loading of the sample

## References

- Cerfontaine, B., Dieudonné, A.C., Radu J. P., Collin, F., Charlier, R. (2015), 3D zero-thickness coupled interface finite element: Formulation and application, *Computers and Geotechnics* 69 (2015) 124–140
- Collin, F. (2003), *Couplages thermo-hydro-mécaniques dans les sols et les roches tendres partiellement saturés*, PhD Thesis, University of Liège
- Di Donna, A., Ferrari, A., Laloui, L. (2015), Experimental investigations of the soil–concrete interface: physical mechanisms, cyclic mobilization, and behaviour at different temperatures, *Can. Geotech. J.* 53: 1–14 (2016)
- Di Donna, A. 2014. *Thermo-mechanical aspects of energy piles*. Ph.D. thesis, Swiss Federal Institute of Technology in Lausanne (EPFL), Lausanne, Switzerland.
- Di Donna, A., and Laloui, L. 2015. Response of soil subjected to thermal cyclic loading: experimental and constitutive study. *Engineering Geology*, 190: 65–76, 2015.
- Laloui, L., Di Donna, A., 2013. *Energy Geostructures: Innovation in Underground Engineering*. ISTE Ltd and John Wiley & Sons Inc. 978-1848215726.
- Pra-Ai, S. (2013), *Behaviour of soil-structure interfaces subjected to a large number of cycles. Application to piles*, PhD Thesis, University of Grenoble





## GeoProc2017

6th International Conference on Coupled THMC Processes in Geosystems  
5-7 Jul 2017 Paris (France)

### Coupled Thermo-Hydro-Mechanical Behavior of Shale

V. Vilarrasa<sup>1,2</sup>, R. Makhnenko<sup>3</sup>

*Keywords: geo-energies, CO<sub>2</sub> storage, cooling, caprock integrity, Opalinus clay*

Geo-engineering applications such as geologic carbon storage, nuclear waste storage, and geothermal energy, imply pressure and temperature changes that induce rock deformation. In these applications, shales often serve as barriers to avoid or limit fluid and waste migration. As a result, maintaining the sealing capacity of shales is crucial for the success of geo-energy and geo-engineering applications.

We focus on the thermo-hydro-mechanical coupled processes that shales may undergo during these applications. Specimens of Opalinus clay – Jurassic shale from Mont Terri underground rock laboratory – are brought to the conditions of relatively shallow (1 km depth) geological storage and fully saturated with in-situ brine. Poromechanical parameters are measured in drained, undrained, andunjacketed compression experiments. Drained and undrained heating and cooling tests provide the corresponding thermal expansion coefficients. Brine in the pores of the shale has higher thermal expansion coefficient than minerals and rock.

Temperature induced stresses combined with changes in the fluid pressure caused by the low permeability of the material (in the order of nanoDarcy) will induce further deformation and may even lead to yield or failure conditions of shale. We apply our analytical model and experimentally measured parameters to reproduce the shaly caprock deformation for the case of geologic carbon storage, where cooling is likely to occur around injection wells (Figure 1). We find that the temperature-induced pressure changes partly counterbalance the thermal stress reduction caused by cooling, which, for most of the storage cases, should not lead to caprock yielding. Moreover, the time-dependent (viscoelastic) nature of shale deformation induces further pore pressure reduction that also contributes to improving its stability.

---

<sup>1</sup> Institute of Environmental Assessment and Water Research, Spanish National Research Council (IDAEA-CSIC), Barcelona, Spain, victor.vilarrasa@upc.edu

<sup>2</sup> Associated Unit: Hydrogeology Group (UPC-CSIC), Barcelona, Spain

<sup>3</sup> Department of Civil & Environmental Engineering, University of Illinois at Urbana-Champaign, USA, romanmax@illinois.edu

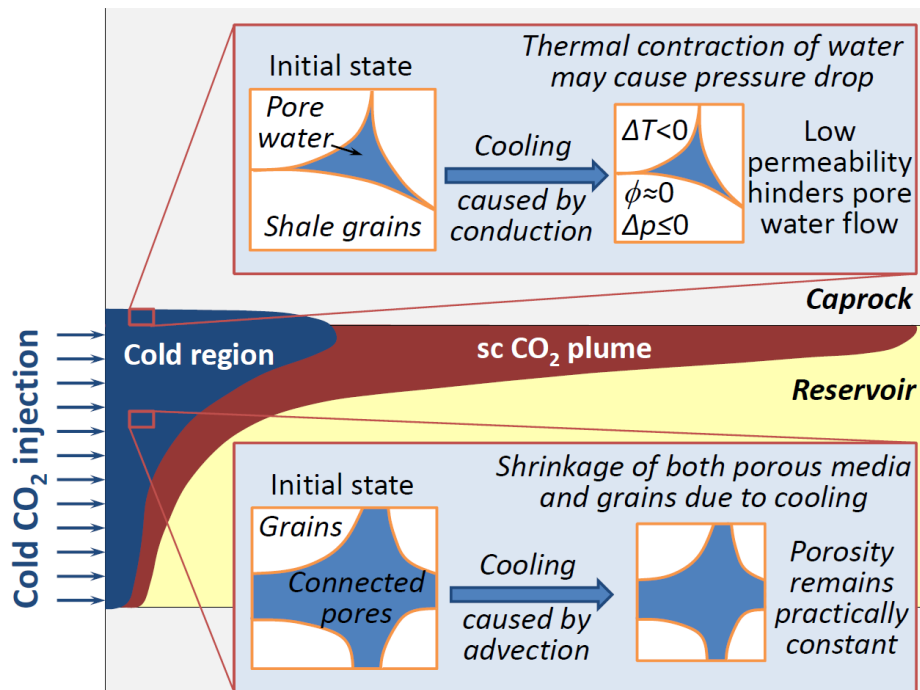

Figure 1. Cold CO<sub>2</sub> region reaches the caprock, where contraction might cause fracturing due to effective stress changes.



## GeoProc2017

6th International Conference on Coupled THMC Processes in Geosystems  
5-7 Jul 2017 Paris (France)

### Thermo-hydro-mechanical modeling of an in situ heating test in the Callovo-Oxfordian claystone

*M. Vitel<sup>1</sup>, D. Seyed<sup>2</sup>, N. Conil<sup>3</sup>, G. Armand<sup>4</sup>*

*Keywords: THM modeling, thermal pressurization, nuclear waste repository, COx, in situ experiment*

Andra (French national radioactive waste management agency) performs a wide range of in situ experiments at its Underground Research Laboratory (MHM URL). The main goal of the experiments is the study of the feasibility of a radioactive waste repository in a Callovo-Oxfordian claystone formation (COx).

Thermo-Hydro-Mechanical (THM) behavior of the COx is of great importance with regard to the design and safety calculations of the high-level and intermediate-level long-lived waste disposals. Concerning the high-level waste, the heat emitted from the waste causes a pore-pressure increase within the surrounding rock due to the thermal expansion of the pore water and the solid skeleton. The low permeability of the COx and its relative rigidity prevents the discharge of the induced pressure build-up. Moreover, thermal loading may provoke thermomechanical stresses in the media due to boundary conditions.

An important research program has been conducted at Andra since 2003 in order to investigate the THM response of the COx to a thermal loading, through laboratory and in situ experimentations. The in situ experimental program consists of a step-by-step approach started by small-scale heating boreholes to full-scale experiments. In parallel, a benchmark exercise organized by Andra is currently in progress within DECOVALEX international program. The purpose of the benchmark is upscaling THM modeling from small size experiments (some cubic meters) to real scale cell (some ten cubic meters) and to scale of the waste repository (cubic kilometers).

Within the frame of the benchmark, the first *in situ* test studied is the TED experiment, a small-scale heating experiment realized in the MHM URL and focused on the claystone THM behavior of the undisturbed rock mass at far field. The experiment lasted 3 years between 2010 and 2013. It involved three 4-meter-long parallel heaters, installed at the end of 160mm diameter and 16m long boreholes, drilled from a main drift and parallel to the maximum horizontal stress. It was heavily instrumented with more than 200 sensors recording temperature and pressure in the rock mass, in the heater boreholes and at the drift wall (Conil, 2012) (see Figure 1).

<sup>1</sup> Andra, R&D Division, Châtenay-Malabry, France, manon.vitel@andra.fr

<sup>2</sup> Andra, R&D Division, Châtenay-Malabry, France, darius.seyedi@andra.fr

<sup>3</sup> Andra, R&D Division, Meuse/Haute-Marne URL, Bure, France, nathalie.conil@andra.fr

<sup>4</sup> Andra, R&D Division, Meuse/Haute-Marne URL, Bure, France, gilles.armand@andra.fr

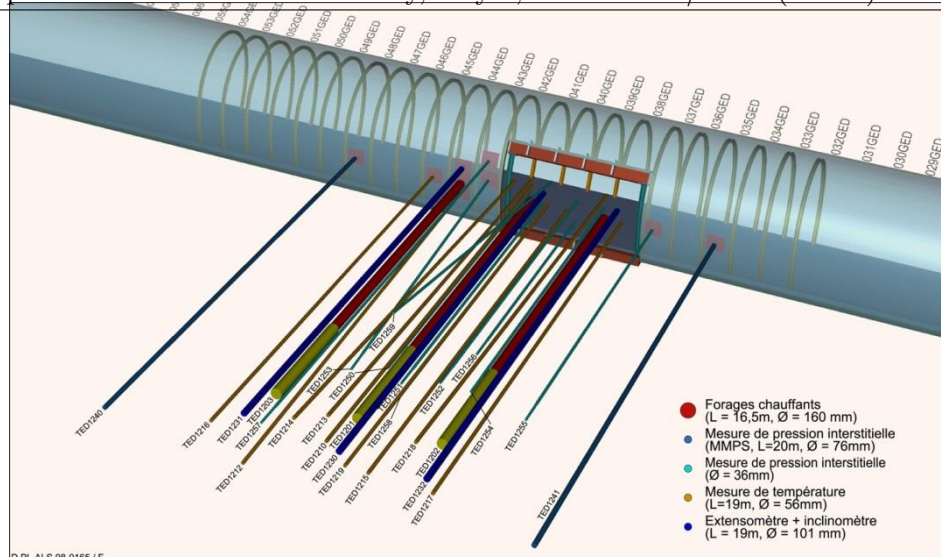

Figure 1 Three-dimensional layout of the TED experiment indicating heaters and instrumentation boreholes

This experiment has been interpreted and modeled so that the experimental results of the test have been back analyzed. For that purpose, a linear thermoporoelastic model is used following the classical theory of poromechanics developed by Coussy (2004). It appears that the prediction of the temperature field evolution is good if the anisotropy of the thermal conductivity is taken into account. Indeed, the rock clearly shows an anisotropic response to the heating load: at equal distance from the heater, the temperature increase is higher in the bedding plane than in the perpendicular direction. Regarding the pressure evolution, observations of pore pressure also showed that its evolution depended on the location with respect to the bedding plane: following a power increase, the pore pressure increased faster in the direction parallel to bedding than in perpendicular direction. Therefore, the anisotropy of the hydraulic and mechanical behaviors also has to be considered in the model. In this way, the evolution of the experimental pore pressure is reproduced well.

Then, the THM parameters obtained through the back analysis of the TED experiment will constitute the reference values to simulate a one-to-one scale heating experiment especially focused on the interaction between the surrounding rock and the support at near field.

## References

- Coussy, O. (2004), Poromechanics, Wiley.
- Conil N., Armand G., Garitte B., Jobmann M., Jellouli M., Filippi M., De La Vaissière, R., Morel, J., In situ heating test in Callovo-Oxfordian claystone: measurement and interpretation, 5th meeting on "Clays in Natural and Engineered Barriers for Radioactive Waste Confinement", 22-25th October 2012, Montpellier



## GeoProc2017

6th International Conference on Coupled THMC Processes in Geosystems  
5-7 Jul 2017 Paris (France)

### Mechanical Degradation Analysis of Sandstone under Chemical Corrosion

*W. Wang<sup>1</sup>, CG. Gong<sup>2</sup>, RB. Wang<sup>3</sup>, WY.Xu<sup>4</sup>*

*Keywords: sandstone, water-rock chemical interaction, mechanical degradation, chemical corrosion*

Sandstone is a natural material, which is largely used in various engineering, such as petroleum engineering and geological sequestration of CO<sub>2</sub>. In these applications, sandstones are likely to be degraded by chemical solutions especially acid solutions. In order to investigate the influence of chemical effect and soak time on the mechanical behaviour of sandstone, a series of uniaxial compression tests on sandstone samples subjected to different chemical solutions with different acidity (pH=2, 4, 7) were conducted. Figure 1 shows the experimental results of uniaxial tests conducted on the sandstones samples immersed in the different chemical solutions for 180 days. The relative qualities, strength and deformation characteristics of sandstone under different water chemical corrosion conditions are investigated, and that the change of pH, Ca<sup>2+</sup> and Mg<sup>2+</sup> concentration of chemical solution are monitored during the soak process. The results indicate that: (1) With the augmentation of the solution acidity, the corrosion degree of Sandstone increases gradually; (2) Sandstone presents a strain softening behavior under chemical solutions, and with the increase of the solution acidity and soak time, the softening effect is more evident while the influence on the ultimate strength of sandstone is not obvious; (3) The different types and degrees of water-rock interaction lead to different changes to microstructure of sandstone, presenting loss of cementing material in neutral solution and significant dissolution of mineral particles in acidic solution.

---

<sup>1</sup> Key Laboratory of Education for Geomechanics and Embankment Engineering, Hohai University, wwang@hhu.edu.cn

<sup>2</sup> Key Laboratory of Education for Geomechanics and Embankment Engineering, Hohai University, gongchuangen1992@163.com

<sup>3</sup> Key Laboratory of Education for Geomechanics and Embankment Engineering, Hohai University, rbwang\_hhu@foxmail.com

<sup>4</sup> Key Laboratory of Education for Geomechanics and Embankment Engineering, Hohai University, wyxu@hhu.edu.cn

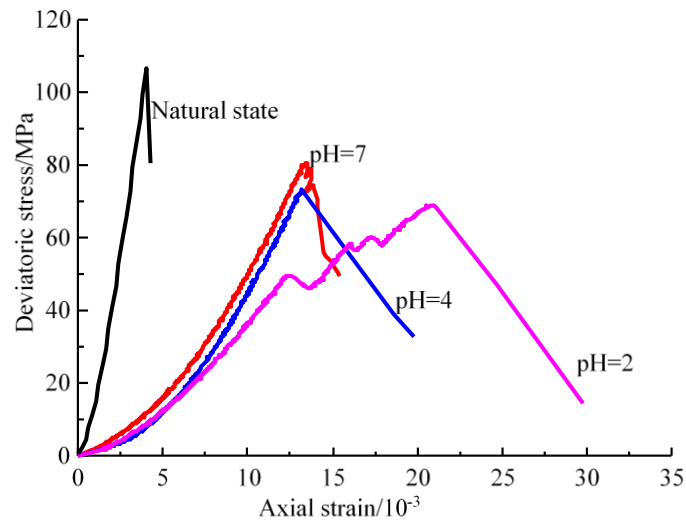

Figure 1. Uniaxial stress-strain curves for sandstone samples soaked in the different chemical solutions for 180 days

## References

- Xie, S.Y., Shao, J.F., Xu, W.Y.(2011), Influences of chemical degradation on mechanical behaviour of a limestone, *International Journal of Rock Mechanics & Mining Sciences*, 48(5): 741–747.
- Wang, W., Liu, T.G., Shao, J.F.(2016). Effects of acid solution on the mechanical behavior of sandstone, *Journal of Materials in Civil Engineering*, 28(1): 04015089.
- Feng, X.T. and Ding W.X.(2007), Experimental study of limestone micro-fracturing under a coupled stress, fluid flow and changing chemical environment, *International Journal of Rock Mechanics and Mining Sciences*, 44(3):437–448.



## GeoProc2017

6th International Conference on Coupled THMC Processes in Geosystems  
5-7 Jul 2017 Paris (France)

### **Flow of CO<sub>2</sub>-rich fluids in simulated wellbore interfaces: Experiments and models exploring reactive transport on length scales of several metres**

*T.K.T. Wolterbeek<sup>1</sup>, A. Raouf<sup>2</sup>, C.J. Spiers<sup>3</sup>*

*Keywords: wellbore integrity, CO<sub>2</sub> storage, cement, reactive transport, permeability*

Structural defects in wellbores, such as fractures or debonding defects along material interfaces, offer pathways for CO<sub>2</sub> to migrate from geological storage systems (Zhang, 2011; Carey 2013). To confidently assess sealing integrity, it is key to obtain an understanding of how the transport properties of such wellbore defects evolve if penetrated by CO<sub>2</sub>-rich fluids. Numerous studies have explored this problem at the decimetre length scale (Luquot, 2013; Liteanu, 2011; Carey, 2010; Wolterbeek, 2013). These studies showed that chemical reaction with CO<sub>2</sub> can lead to degradation of the cement and steel, when subjected to large volumes of CO<sub>2</sub>-rich fluid (Duguid, 2011), possibly resulting in enhancement of leakage. However, previous work also showed that limited CO<sub>2</sub>-cement alteration can lead to precipitation of calcium carbonate, providing potential for self-sealing (Liteanu, 2011; Bachu, 2009). Which effect will dominate depends on the specific reactive transport conditions, and on the extent of the system. While cement barriers in real wells generally involve 10s to 100s of metres of cement (Carey, 2013), such long length scales have so far received little attention in experimental and modelling studies (Manceau, 2015). To reduce scale discrepancy, this work addresses flow of CO<sub>2</sub>-rich fluids in wellbore defects of 1-6 m long, by means of a combined experimental and modelling study.

The lab work consisted of 4 reactive flow-through tests, performed on cement-filled steel tubes (length 1-6 m, inner diameter 6-8 mm) containing artificially debonded steel-cement interfaces (Wolterbeek, 2016). The tests involved flow-through of CO<sub>2</sub>-rich fluid at pressures of 10-15 MPa, and temperatures of 60-80 °C, imposed by controlling the fluid pressure difference at 0.12-4.8 MPa, while measuring fluid flux. After flow-through testing, the samples were subjected to microstructural/microchemical study. In the modelling work, we developed a numerical model to explore reactive transport in CO<sub>2</sub>-exposed wellbore defects on length scales similar to the lab experiments. The formulation adopted incorporates fluid flow, advective and diffusive solute transport, and a simple reaction scheme representing the CO<sub>2</sub>-

<sup>1</sup> Experimental Rock Deformation Group, Utrecht University, the Netherlands, [t.k.t.wolterbeek@uu.nl](mailto:t.k.t.wolterbeek@uu.nl)

<sup>2</sup> Hydrogeology Group, Utrecht University, the Netherlands, [a.raouf@uu.nl](mailto:a.raouf@uu.nl)

<sup>3</sup> Experimental Rock Deformation Group, Utrecht University, the Netherlands, [c.j.spiers@uu.nl](mailto:c.j.spiers@uu.nl)

cement chemistry (Raof, 2012). Our results show that long-range reactive transport strongly affects the permeability evolution of CO<sub>2</sub>-exposed defects. In the lab tests, apparent permeability decreased by 2-4 orders, which microstructural observations show to be associated with downstream precipitation of calcium carbonates, possibly aided by migration of fines (Figure 1). The model simulations show that precipitation inside initially open defects produces a sharp decrease in flow rate, causing a transition from advection to diffusion-dominated reactive transport. While the modelling results broadly reproduce the lab observations, it is also shown that non-uniformity in the initial defect aperture has a profound impact on metre-scale self-sealing and permeability evolution. The implication is that future reactive transport models and wellbore analyses should consider defects with variable aperture to obtain reliable upscaling relations.

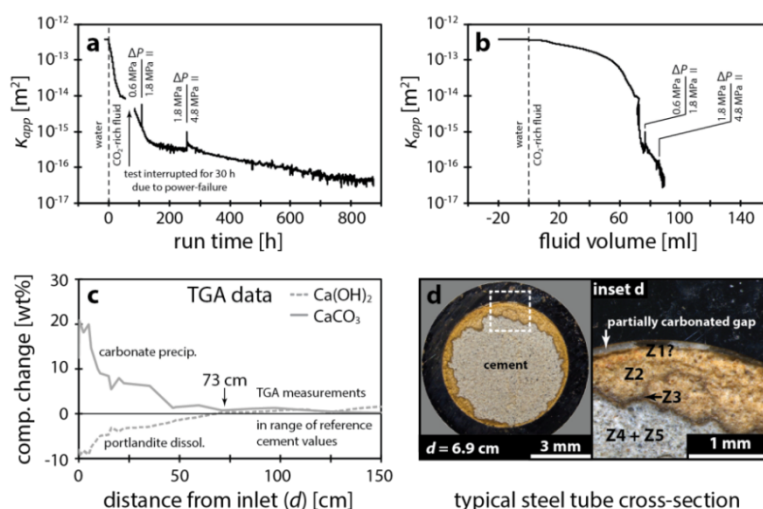

Figure 1. Example results lab tests: a-b) Apparent permeability ( $K_{app}$ ) of the cement-filled steel tube with time and injected fluid volume. Zero time and zero injected volume are taken at the moment flow-through using CO<sub>2</sub>-rich fluid started. c) Profiles showing change in Ca(OH)<sub>2</sub> and CaCO<sub>3</sub> content of the cement with downstream distance from the fluid inlet, data obtained from TGA. Compositional change is defined as difference between the measured composition and that of unreacted, reference material. d) Typical cross-section through the reacted cement-filled steel tube, showing the debonding defect at the cement-steel interface, and reaction zones present in the adjacent cement (Z1-Z5).

## References

- Bachu, S., Bennion, D.B., Experimental assessment of brine and/or CO<sub>2</sub> leakage through well cements at reservoir conditions, *Int. J. Greenh. Gas Control.* 3 (2009) 494–501.
- Carey, J.W., Svec, R., Grigg, R., Zhang, J., Crow, W., Experimental investigation of wellbore integrity and CO<sub>2</sub>-brine flow along the casing-cement microannulus, *Int. J. Greenh. Gas Control.* 4 (2010) 272–282.
- Carey, J.W., Geochemistry of wellbore integrity in CO<sub>2</sub> sequestration: Portland cement-steel-brine-CO<sub>2</sub> interactions, *Rev. Mineral. Geochemistry.* 77 (2013) 505–539.
- Duguid, A., Radonjic, M., Scherer, G.W., Degradation of cement at the reservoir/cement interface from exposure to carbonated brine, *Int. J. Greenh. Gas Control.* 5 (2011) 1413–1428.
- Liteanu, E., Spiers, C.J., Fracture healing and transport properties of wellbore cement in the presence of supercritical CO<sub>2</sub>, *Chem. Geol.* 281 (2011) 195–210.
- Luquot, L., Abdoulghafour, H., Gouze, P., Hydro-dynamically controlled alteration of fractured Portland cements flowed by CO<sub>2</sub>-rich brine, *Int. J. Greenh. Gas Control.* 16 (2013) 167–179.
- Manceau, J.-C., Tremosa, J., Audigane, P., Lerouge, C., Claret, F., Lettry, Y., Well integrity assessment under temperature and pressure stresses by a 1: 1 scale wellbore experiment, *Water Resour. Res.* 51 (2015) 6093–6109.
- Raof, A., Nick, H.M., Wolterbeek, T.K.T., Spiers, C.J., Pore-scale modeling of reactive transport in wellbore cement under CO<sub>2</sub> storage conditions, *Int. J. Greenh. Gas Control.* 11 (2012) S67–S77.
- Wolterbeek, T.K.T., Peach, C.J., Spiers, C.J., Reaction and transport in wellbore interfaces under CO<sub>2</sub> storage conditions: Experiments simulating debonded cement-casing interfaces, *Int. J. Greenh. Gas Control.* 19 (2013) 519–529.
- Wolterbeek, T.K.T., Peach, C.J., Raof, A., Spiers, C.J., Reactive transport of CO<sub>2</sub>-rich fluids in simulated wellbore interfaces: Flow-through experiments on the 1-6 m length scale, *Int. J. Greenh. Gas Control.* 54 (2016) 96–116.
- Zhang, M., Bachu, S., Review of integrity of existing wells in relation to CO<sub>2</sub> geological storage: What do we know? *Int. J. Greenh. Gas Control.* 5 (2011) 826–840.





## GeoProc2017

6th International Conference on Coupled THMC Processes in Geosystems  
5-7 Jul 2017 Paris (France)

### Hydro-mechanical time-dependent deformation, creep and fracturing of brittle rocks

T. Xu<sup>1</sup>, G.L. Zhou<sup>2</sup>, M. Heap<sup>3</sup>, Heinz Konietzky<sup>4</sup>, C.F. Chen<sup>5</sup>

*Keywords: time-dependent brittle creep, pore pressure, creep strain rate, damage evolution, numerical simulation.*

A numerical hydro-mechanical meso-scale model for brittle creep is proposed to describe the time-dependent brittle deformation of heterogeneous brittle rock under loading conditions at different constant pore pressures and confining pressures. The model accounts for material heterogeneity and local material degradation. Importantly, the model introduces the concept of a mesoscopic renormalization to capture the cooperative interaction between microcracks in the transition from distributed to localized damage. The model also describes the temporal and spatial evolution of acoustic emissions during the progressive damage process of the rock. The model is validated against previously-published experimental data and is then used to simulate brittle creep experiments of heterogeneous rock under varying constant pore pressures, applied axial stresses and confining pressures. Our model accurately reproduces the classic creep behaviour observed in laboratory tests. The simulations also show evidence of a 'critical level of damage' before the onset of tertiary creep and that the initial stages of localization can be seen as early as the start of the secondary creep phase, both of which have been previously observed in experiments. Our approach differs from previously-adopted macroscopic approaches, based on constitutive laws, and microscopic approaches that focus on fracture propagation. The model shows that complex macroscopic time-dependent behaviour can be explained by the small-scale interaction of elements. The fact that the simulations are able to capture a similar time-dependent response of heterogeneous brittle rocks to that seen in the laboratory implies that the model is appropriate to investigate the non-linear complicated time-dependent behaviour of heterogeneous brittle rocks.

In the model, a Norton-bailey equation to describe the strain rate of the secondary creep is adopted to characterize time-dependent creep deformation.

---

<sup>1</sup> School of Resources and Civil Engineering, Northeastern University, Shenyang110819, China, xutao@mail.neu.edu.cn

<sup>2</sup> School of Resources and Civil Engineering, Northeastern University, Shenyang110819, China, guangleizhou@qq.com

<sup>3</sup> Laboratoire de Géophysique Expérimentale, Institut de Physique de Globe de Strasbourg (UMR 7516 CNRS, Université de Strasbourg/EOST), 5 rue René Descartes, 67084 Strasbourg cedex, France.

<sup>4</sup> Geotechnical Institute, TU Bergakademie Freiberg, Gustav-Zeuner-Str. 1, 09596 Freiberg, Germany

<sup>5</sup> School of Resources and Civil Engineering, Northeastern University, Shenyang110819, China, chenchongfeng1991@qq.com

$$\varepsilon_c = A\sigma^n t^m \exp\left(-\frac{U}{RT}\right) \quad (1)$$

The fluid flow description and stress description are :

$$c_1 \frac{\partial \varepsilon_V}{\partial t} + c_2 \frac{\partial p}{\partial t} = \nabla \cdot [\kappa(\nabla p + \rho_l g \nabla z)] \quad (2)$$

where  $c_1 = 1 - K'/K_s$  and  $c_2 = \varphi/\beta_l + (1 - \varphi)/K_s$

$$(\lambda + G) \cdot u_{j,ji} + Gu_{i,jj} + f_i - \alpha p_{,i} = 0 \quad (3)$$

The validation of our model against previously-published experimental data from brittle creep experiments on sandstone under different constant pore pressures is shown in Figure 1 and the damage evolution of the specimens is shown in Figure 2.

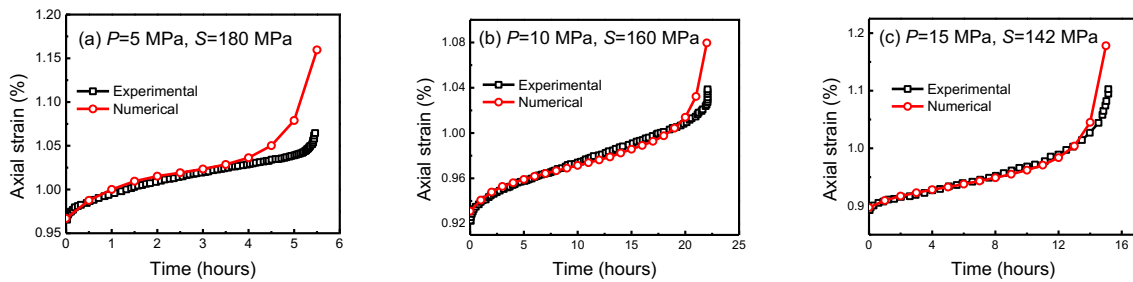

Figure 1. Comparisons between numerical and experimental creep curves at various constant pore pressures of 5 MPa, 10 MPa, and 15 MPa

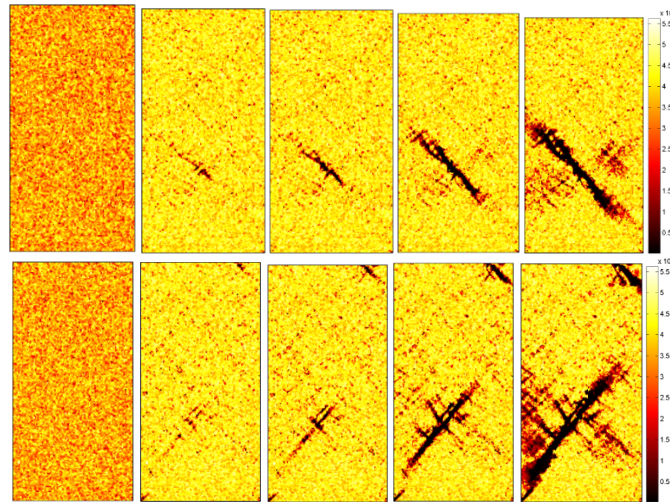

Figure 2. Damage evolution of specimens at various constant pore pressures of 5 MPa and 10 MPa

The author gratefully acknowledges the support of K.C. Wong education foundation, Hongkong.

## References

- Brantut N, Baud P, Heap MJ, Meredith PG (2012) Micromechanics of brittle creep in rocks. *Journal of Geophysical Research* 117: B08412.
- Heap MJ, Baud P, Meredith PG, Bell AF, Main IG (2009) Time-dependent brittle creep in Darley Dale sandstone. *Journal of Geophysical Research* 114: 1-22.
- Yang S-Q, Jing H-W, Cheng L (2014) Influences of pore pressure on short-term and creep mechanical behavior of red sandstone. *Engineering Geology* 179: 10-23
- Kranz RL (1980) The effects of confining pressure and stress difference on static fatigue of granite. *Journal of Geophysical Research* 85: 1854-1866



## GeoProc2017

6th International Conference on Coupled THMC Processes in Geosystems  
5-7 Jul 2017 Paris (France)

### **Mechanical properties of thin-layered rock masses in dry and water-soaked conditions and their influences on stability of large tunnels**

*YutingZhang<sup>1</sup>, XiuliDing<sup>2</sup>, Shuling Huang<sup>3</sup>*

*Keywords: field test; thin-layered rock mass; water-soaked condition; mechanical property; tunnel stability*

Many hydraulic tunnels, such as diversion tunnels of hydropower plants and water conveyance tunnels of water conservancy projects, face different underground water environment at different construction stages. The surrounding rock masses of tunnels which are dry during construction stage, become wet due to the rise of underground water level caused by upstream impoundment.

The variation of surrounding rock mass mechanical properties is thus important for tunnels to maintain structural stability. The mechanical properties of thin-layered rock masses in both dry (Figure 1) and water-soaked (Figure 2) conditions were investigated by field tests and the rock masses were found to be degraded to a certain extent. Quantitative analysis was then carried out to generalize the water-soaked effect and formulate the degradation law. Afterwards, numerical analysis was conducted on consider the water variation process and its impact to structural stability of tunnels (Figure 3).

It is concluded that, due to the confinement of lining structures, the stability of surrounding rock masses is still achieved despite of material degradation effect. However, it is also suggested certain monitoring measures should be adopted to guarantee the tunnel safety.

---

<sup>1</sup>Yangtze River Scientific Research Institute, Wuhan, China, magicdonkey@163.com

<sup>2</sup>Yangtze River Scientific Research Institute, Wuhan, China, dingxl@crsri.cn

<sup>3</sup>Yangtze River Scientific Research Institute, Wuhan, China, huangsl\_2002@foxmail.com



Figure 1. Field test on thin-layer rock masses in dry condition.



Figure 2. Field test on thin-layer rock masses in water soaked condition.

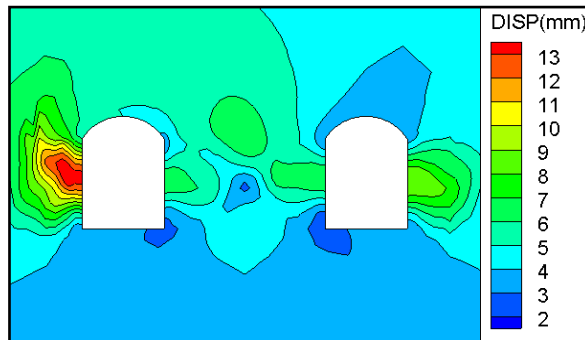

Figure 3. Incremental deformation of surrounding rock masses due to water-soaked effect



## GeoProc2017

6th International Conference on Coupled THMC Processes in Geosystems  
5-7 Jul 2017 Paris (France)

### Multiphysics Modelling in the Frame of Deep Geothermal Energy Systems

A.Dimier<sup>1</sup>, Y.Nusiaputra<sup>2</sup>, S.Ghabezloo<sup>3</sup>, O.Ukelis<sup>4</sup>, R.Zorn<sup>5</sup>, T.Kohl<sup>6</sup>

*Thermal, Hydrology, Mechanics, Geo-Chemistry, multi-physics modeling*

Worldwide, geothermal energy is identified as a high potential energy source. Nevertheless, research still needs to be carried out on deep geothermal energy systems; even though its productivity can be already enhanced by stimulation methods like acid treatment and hydraulic stimulation, in other words hydraulic fracturing.

Therefore numerical modelling of hard rocks mechanical behavior and of injection processes is one of the most promising way to optimize geothermal processes and to make them more cost effective.

Because of the limited amount of in situ data available and consequently of necessary assumptions to be incorporated in the numerical models, experimental studies and their related modelling are mandatory to identify and try to mimic involved processes. Therefore we will present here parts of the modelling efforts made at the KIT (Karlsruhe Institute of Technology) related to that topic, this partially in collaboration with the ENPC (École Nationale des Ponts et Chaussées)

We will introduce the etumos environment where various multi-physical simulation software's with disjunctive application fields, like phreeqC, see (USGS, 2017), Elmer (2017) and Openfoam (2017), are gathered within one single environment in order to broaden their respective application area.

Within that frame, autoclave experiments followed by tri-axial mechanical experiments have been carried out on a calcareous sandstone, a so called "Pierre de Lens", in order to setup the necessary elements of the numerical model enabling to understand and model the involved processes and their coupling. The numerical modelling linking the mechanical behavior to the chemical evolution of the sandstone is depicted figure 1.

We will also present the different elements of the two phase's numerical model enabling to simulate the thermal production/injection of wells, so called WellboreKit (van Rossum,

<sup>1</sup> KIT, alain.dimier@eifer.uni-karlsruhe.de

<sup>2</sup> KIT, yodha.nusiaputra@kit.edu

<sup>3</sup> ENPC, siavash.ghabezloo@enpc.fr

<sup>4</sup> KIT, olaf.ukelis@eifer.uni-karlsruhe.de

<sup>5</sup> KIT, roman.zorn@eifer.uni-karlsruhe.de

<sup>6</sup> KIT, thomas.kohl@kit.edu

2008) as illustrated on Figure 2 and 3. The reactive wellbore simulator employs equation of state for NaCl/CaCl<sub>2</sub>/KCl/MgCl<sub>2</sub>-CO<sub>2</sub>/N<sub>2</sub>/CH<sub>4</sub>/H<sub>2</sub>S system (Dimier et al., in prep.). Thanks to the aforementioned Elmer-Phreeqc environment, mineral precipitations along the wellbore path can be evaluated.

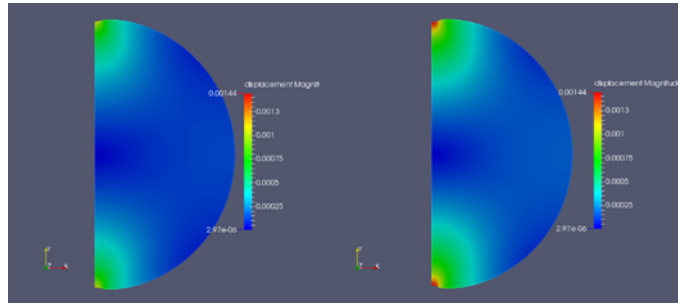

Figure 1. Brazilian test, displacement evolution over time induced by a Calcite dissolution.

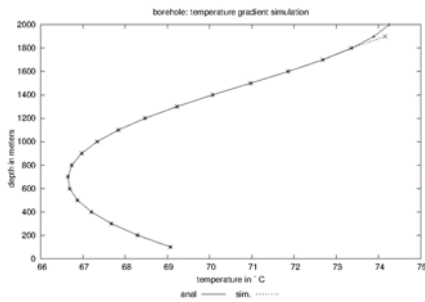

Figure 2 One phase borehole, anal. Sol.

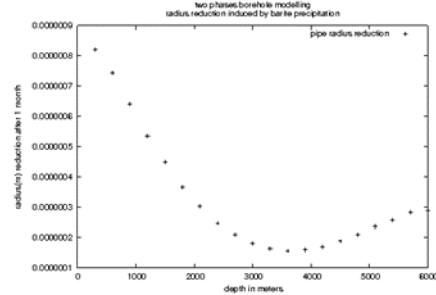

Figure 3 Two phases' simulation

## References

- CSC, <http://www.csc.fi/english>, accessed June 2017.
- Dimier, A., et al. (2017) Dynamic Thermohydro-Chemical Modeling of Geothermal Well Flow with Two-Phase Multicomponent Fluids (in prep.).
- Openfoam, <http://openfoam.com/>, accessed June 2017.
- USGS, <http://www.usgs.gov>, accessed June 2017.
- van Rossum, G. (2008), Extending and Embedding the Python Interpreter, Release 2.5.2.



## GeoProc2017

6th International Conference on Coupled THMC Processes in Geosystems  
5-7 Jul 2017 Paris (France)

### 3D Numerical Study on Permeability Property of Columnar Jointed Rock

Q.X. Meng<sup>1</sup>, W.Y. Xu<sup>2</sup>, H.L. Wang<sup>3</sup>

*Keywords: Columnar jointed rock; Distinct element method; Stress-dependent permeability; Size effect*

Based on the engineering practice in Baihetan Hydropower Station, this paper investigates the stress-dependent permeability issue in columnar jointed basalt considering the effects of normal deformation and shear dilation of fractures employing three-dimensional distinct element method program, 3DEC. A realistic discrete fracture network realization algorithm based on modified constraint centroid Voronoi method is proposed according to in-site geological survey. Large number of numerical experiments were implemented to calculate changes in the permeability of columnar jointed rock under various structure and loading conditions. These numerical tests were conducted in two ways: (1) variation of different columnar joints structure; and (2) variation of different stresses (i.e., hydrostatic and deviatoric state of stress). Numerical tests indicate that the permeability of columnar jointed rocks have obvious size effect and permeability tends to be transversely isotropic with the increasing of size. The joints structure properties like density and homogeneity have significant impact on permeability. Permeability decreases with increased stress magnitudes before the shear dilation is happen, while permeability increases with stress magnitudes when the stress ratio is large enough. Induced anisotropy of permeability appears with the increase of deviatoric stress.

---

<sup>1</sup>Research Institute of Geotechnical Engineering, Hohai University, Nanjing 210098, China  
wxyxu@hhu.edu.cn

<sup>2</sup> Research Institute of Geotechnical Engineering, Hohai University, Nanjing 210098, China  
mqx4088@gmail.com

<sup>3</sup>Key Laboratory of Coastal Disaster and Defense of Ministry of Education, Hohai University, Nanjing 210098 China, whl\_hm@163.com

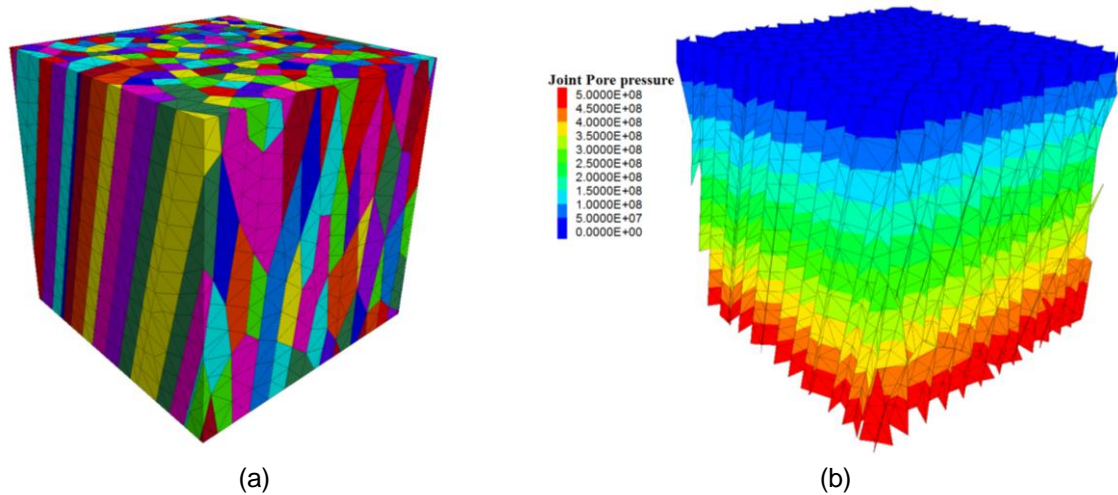

Figure 1. Joint flow in columnar jointed rock mass:(a) Columnar jointed rock mass,(b) Pore pressure distribution

## References

- Min, K.-B., Rutqvist, J., Tsang, C.-F. and Jing, L (2004). Stress-dependent permeability of fractured rock masses: a numerical study. *Int J Rock Mech Min*, 41(7):1191-1210. doi:10.1016/j.ijrmms.2004.05.005
- Baghbanan A and Jing L (2008) Stress effects on permeability in a fractured rock mass with correlated fracture length and aperture. *Int J Rock Mech Min*, 45(8):1320-1334. doi:10.1016/j.ijrmms.2008.01.015





## GeoProc2017

6th International Conference on Coupled THMC Processes in Geosystems  
5-7 Jul 2017 Paris (France)

### Research on the impact of principle stress ratio on geological disaster

Zhenlong Song<sup>1,2</sup>, Guangzhi Yin<sup>1,2</sup>, Delei Shang<sup>1,2</sup>, Minghui Li<sup>1,2</sup>

*Keywords: principle stress ratio; peak strength; creep ; brittleness; permeability*

In this paper, we focus on how the principle stress ratio influences the triggering of geological disaster under the fluid-solid coupling condition. The volume stress kept constant and  $\sigma_1$  was loaded at a constant speed until rock sample broken under different ratios of principle stresses. During the test, 1 MPa injection pressure of gas (CH<sub>4</sub>) was introduced to the sample to investigate the transport properties of fluid. The results are as follows. These loading tests were carried out by using Multi-functional true triaxial fluid-solid coupling experiment system (figure 1). With the same volume stress, by increasing the ratio of intermediate and minimum stresses, the creep speed of the rock became faster at the same  $\sigma_1$  level and the rock lithologic character response changed from plasticity to brittleness. The peak strength decreases at a similar linear interrelationship with the increase of ratios of intermediate and minimum principle under the same volume stress. This phenomenon indicates that when the maximum principle stress stay the same in the underground stratum, increasing the ratio of the intermediate and minimum stresses may trigger geological disaster, and these disasters tend to cause sudden outburst. Meanwhile, the  $\sigma_1$ - $\varepsilon_1$  curve and Q- $\varepsilon_1$  curve have a very good corresponding relationship. It suggests that the gas flow has a closer contact with cracks including micro- and macro-cracks than the magnitude of  $\sigma_1$ . The essential relationship between them is the development of cracks.

**Instructions:** There are few research achievements of rock mechanics and seepage characteristics under true triaxial stress condition. The true triaxial strength experiments data demonstrated that the compressive strength increases with the magnitude of  $\sigma_2$ , reaching the level of up to 10%-100% higher than the peak strength in conventional triaxial test on different kinds of rocks(Haimson, 2009; Lee & Haimson, 2007; Pan, Feng, & Hudson, 2012). As well as the permeability values were found to be higher under true triaxial stresses than under their corresponding equivalent hydrostatic stresses(Al-Harthy et al., 1999), and it were affected more in the axial direction ( $\sigma_1$ ) than the other two horizontal directions ( $\sigma_2$  and  $\sigma_3$ )(Young & Nasser, 2011). Meanwhile, the transport property is also affected by the intermediate principal. At the same time, permeability is affected by stress, pore pressure, adsorption expansion deformation and fluid slippage effect. Gray established a permeability calculation model considering the pore pressure and Adsorption strain(Gray, 1987).

<sup>1</sup> state key laboratory of coal mine disaster dynamics and control, zhenlongsong@cqu.edu.cn

<sup>2</sup> Chongqing University, zhenlongsong@cqu.edu.cn

Therefore, stress ratio play an important role in failure strength, deformation features and permeability. And as rock stratum experienced complicated geological tectonism, the stress state under the ground is often in a state of true triaxial stress. It is essential to carry out true triaxial test in the state of three-dimensional unequal compressive stresses.

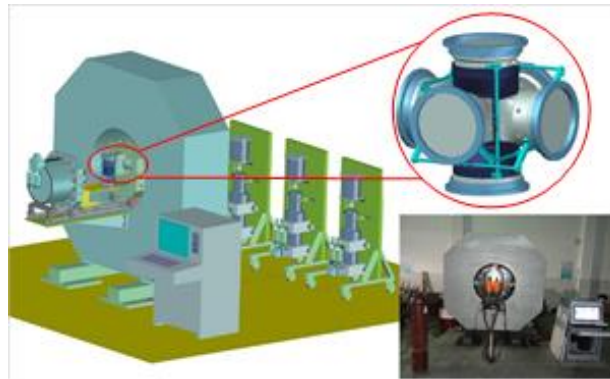

Fig.1 Multi-functional true triaxial H-M coupling experiment system

## References

- Al-Harthy, S., Jing, X., Marsden, J., Dennis, J., Al-Harthy, S., Marsden, J., & Dennis, J. (1999). Petrophysical Properties of Sandstones Under True Triaxial Stresses I: Directional Transport Characteristics and Pore Volume Change *SPE Asia Pacific Improved Oil Recovery Conference*, doi: 10.2523/57287-ms.
- Gray. (1987). Reservoir engineering in coal seams. *Spe Reservoir Engineering*, 2(1), 28-34, doi: 10.2118/12514-PA
- Haimson, B. (2009). A three-dimensional strength criterion based on true triaxial testing of rocks *Proceedings of the ISRM-Sponsored International Symposium on Rock Mechanics: "Rock Characterisation, Modelling and Engineering Design Methods" (SINOROCK2009)*, doi:
- Lee, H., & Haimson, B. (2007). True Triaxial Strength and Brittle Fracture of the Granodiorite at the SAFOD Drillhole Wall, and the Potential for Estimating the Maximum Horizontal Principal Stress *AGU Fall Meeting Abstracts*.
- Pan, P. Z., Feng, X. T., & Hudson, J. A. (2012). The influence of the intermediate principal stress on rock failure behaviour: A numerical study. *Engineering Geology*, 124(2), 109-118, doi: 10.1016/j.enggeo.2011.10.008
- Young, R., & Nasser, F. (2011). Seismic and Transport Properties of Fontainebleau Sandstone: Fracturing Experiments under True Triaxial Stress Conditions. *Agu Fall Meeting Abstracts*.



## GeoProc2017

6th International Conference on Coupled THMC Processes in Geosystems  
5-7 Jul 2017 Paris (France)

### **Experimental investigation of shear creep behavior of discontinuity involved in rock mass**

*HL. Wang<sup>1</sup>, QX. Meng<sup>2</sup>, WY. Xu<sup>2</sup>, RB. Wang<sup>2</sup>*

*Keywords: Shear creep, Discontinuity, Normal stress, Shear deformation, Shear creep model*

Laboratory shear creep tests have been carried out on undisturbed discontinuity samples collected from field of Baihetan hydropower station. In order to investigate the shear creep behavior of discontinuity involved in rock mass, a creep model for discontinuity involved in rock mass was proposed in the study. The shear deformation and shear creep rate with time, as well as the long-term stress were also analyzed. The results showed that the shear creep deformation can reach more than 5 mm. During the multi-loading process of shear stress, the creep curves could show us primary creep stage, steady-state creep stage and tertiary creep stage. In the initial load, the shear creep rate decreased quickly in the first place, and then gradually became stable. However, in the final load, the creep rate coincided with the tertiary creep stage increased rapidly. The primary and steady-state creep of discontinuity can be described by burgers model when the accelerate behavior was corresponding to a modified burgers model, this is not different that of shale which was suggested a non-stationary and nonlinear visco-elastic shear creep model to describe the shear creep experimental results.

The rheology and time-dependent behavior of rock are extremely important for the safety and long-term stability of rock engineering, such as hydroelectric dam, underground oil and gas deport, etc. The natural rock mass is under complex stress field. In situ delayed failure may occur in several days or even in several years after the excavation. Therefore, it is essential to consider the creep behavior of rock materials for construction projects. Previous studies help us to understand the shear creep property of rock and rock like materials. However, the natural rock mass always exhibits geological discontinuities, for example, joints, fractures, bedding planes, rock cleavage, foliation, shear zones and faults (Singhal and Gupta, 1999). In recent years, research progresses about the shear creep behavior of man-made discontinuity have been reported (Zhang, Shen, Ding and Clark, 2012, Atapour and Moosavi, 2013, Zhang, Shen, Jang and Ding, 2016). However, the discontinuities involved in a rock mass are always soft, friable and with lower strength. The undisturbed samples are very hard to collect from field.

---

<sup>1</sup> Key Laboratory of Coastal Disaster and Defense, Ministry of Education, Hohai University, Nanjing 210098, [wanghuanling@hhu.edu.cn](mailto:wanghuanling@hhu.edu.cn)

<sup>2</sup> China Research Institute of Geotechnical Engineering, Hohai University, Nanjing 210098, China, [tianyameng@hhu.edu.cn](mailto:tianyameng@hhu.edu.cn),

Consequently, the experimental data about such field is rare. Baihetan hydropower station is an arch dam and underground hydroelectric power plant currently being constructed on the Jinsha River, a tributary of the Yangtze River in Yunnan and Sichuan provinces of China. It will be the second largest dam in China and the third in the world, in terms of installed capacity. Field geological investigations indicated that many discontinuities, such as inter-layer bedding planes, inner-layer bedding planes, faults and base cracks develop in the rock mass of dam region (Fig. 1).

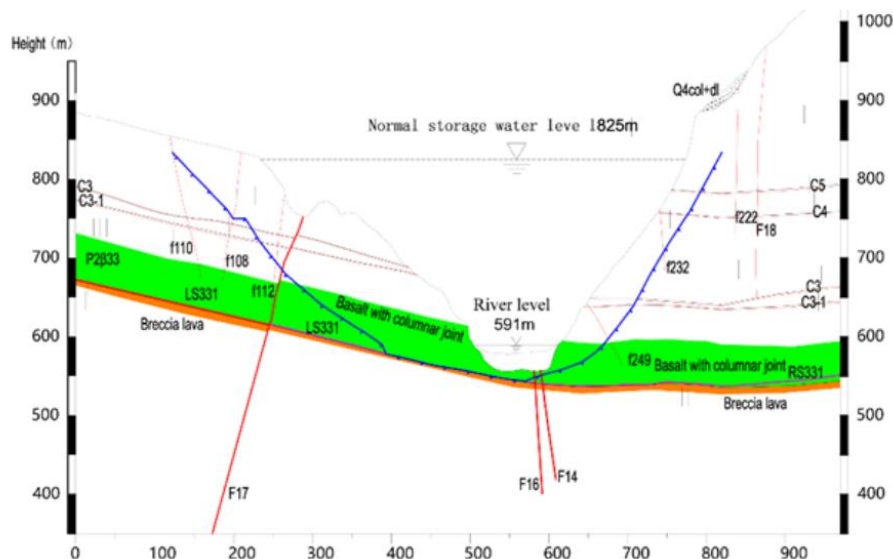

Figure 1. Geological profile of Baihetan dam region.

## References

- Singhal, B., and R. Gupta (1999), Fractures and discontinuities, Applied Hydrogeology of Fractured Rocks, Springer, 13-35.
- Zhang, Q. Z., Shen, M. R., Ding, W. Q., and C. Clark(2012), Shearing creep properties of cements with different irregularities on two surfaces, J Geop Eng, 9(2), 210-217.
- Atapour, H., and M. Moosavi (2013), The Influence of Shearing Velocity on Shear Behavior of Artificial Joints, Rock Mech Rock Eng, 47(5), 1745-1761
- Zhang, Q. Z., Shen, M. R., Jang, B. A., and W. Q. Ding (2016), Creep Behavior of Rocks with Rough Surfaces, J Mater Civil Eng, 4, 60-63.



## GeoProc2017

6th International Conference on Coupled THMC Processes in Geosystems  
5-7 Jul 2017 Paris (France)

### **Hydro-mechanical Coupled Elasto-visco-plastic Damage Analysis of Columnar Jointed Basalt in Baihetan Hydropower Station**

*W.Y. Xu<sup>1</sup>, Q.X. Meng<sup>2</sup>, H.L.Wang<sup>3</sup>*

*Keywords: Elasto-visco-plastic Damage; Columnar Jointed Basalt; Hydro-mechanical Coupling; Anisotropy*

Long term behavior of rock mass in dam foundation under high water pressure and in-situ stress is a key factor affecting the safety of hydraulic project. Baihetan Hydropower Station is an arch dam on the foundation with columnar jointed basalt, a typical poor geological body in Southwest China. The structural characteristics of columnar jointed basalt leads to complex anisotropic and nonlinear properties. This paper gives a numerical study of columnar jointed basalt and its influence on the whole project. An elasto-visco-plastic damage model incorporating a microstructure tensor for anisotropy is proposed firstly. Then a stress dependent permeability evolution law is built to represent the effect of stress on permeability. Numerical analysis using FLAC3D and geometry model based on geological information is implemented finally. Time-dependent behavior of columnar jointed rock under fluctuant reservoir water levels is analyzed. The result indicates that the dam is in stable state overall and suggested engineering measures are also proposed based on the numerical results.

---

<sup>1</sup>Research Institute of Geotechnical Engineering, Hohai University, Nanjing 210098, Chinawyxu@hhu.edu.cn

<sup>2</sup> Research Institute of Geotechnical Engineering, Hohai University, Nanjing 210098, China mqx4088@gmail.com

<sup>3</sup>Key Laboratory of Coastal Disaster and Defense of Ministry of Education, Hohai University, Nanjing 210098 China, whl\_hm@163.com

**Instructions:** Long term behavior of columnar jointed rock under complex environment coupled with high pore water pressure and in-situ stress is not only the key technique problem effecting the long term safety of hydraulic engineering problem, but also a theory problem including anisotropy, multiphysics and creep damage. Based on the engineering of Baihetan Hydropower Station, this paper presents a numerical elasto-visco-plastic damage analysis coupled with fluctuant seepage filed.

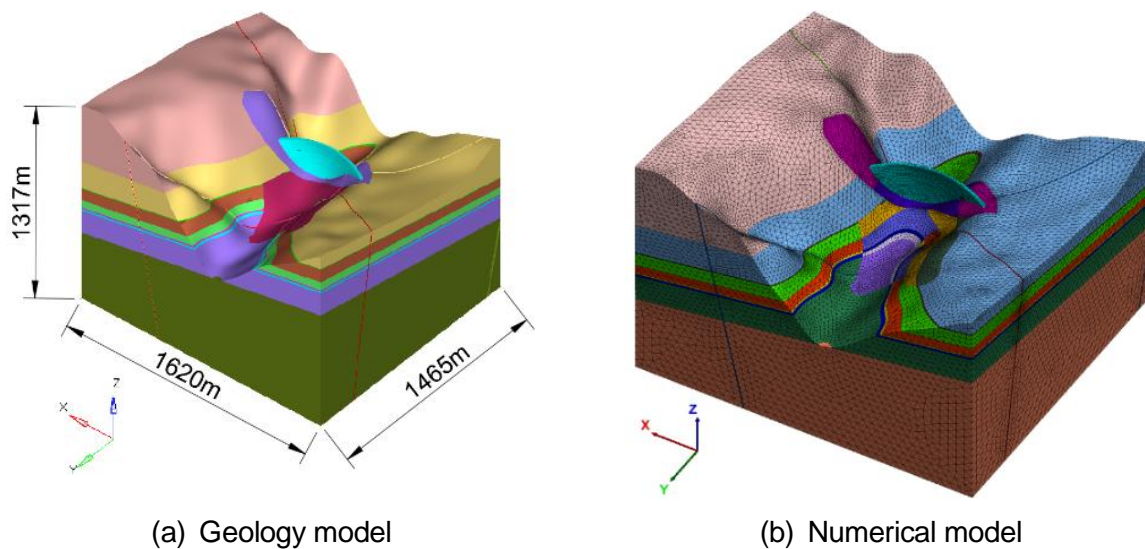

Figure 1. Arch dam and foundation model of Baihetan hydropower station

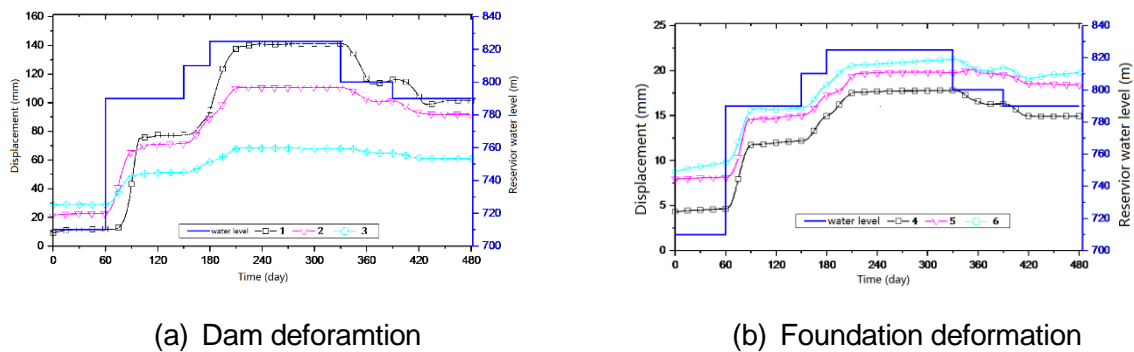

Figure 2. The deformation process of Baihetan hydropower station

## References

- Pietruszczak S, Lydzba D and Shao J-F. (2004) Description of creep in inherently anisotropic frictional materials. *J Eng Mech-Asce*. 130(6):681-90, doi:10.1061/(ASCE)0733-9399
- Xian-Jie Hao Xia-Ting Feng, Cheng-Xiang Yang, Quan Jiang and Shao-Jun Li (2016). Analysis of EDZ Development of Columnar Jointed Rock Mass in the Baihetan Diversion Tunnel. *Rock Mech Rock Eng*. 49(4):1289–1312. doi:10.1007/s00603-015-0829-4



## GeoProc2017

6th International Conference on Coupled THMC Processes in Geosystems  
5-7 Jul 2017 Paris (France)

### Numerical Homogenization Analysis on Elastic Property of Jointed Rock with Crystalline Structure

WY. Xu<sup>1</sup>, QX. Meng<sup>2</sup>, HL. Wang<sup>3</sup> M. He<sup>4</sup>

*Keywords: Numerical homogenization, Periodic boundary conditions, Crystalline jointed rock, Equivalent elastic property*

Rock joint, usually filled by weak material, is a common geological structure, which has significant influence on engineering. Aimed at columnar basalt widely distributed in Southwestern China, this paper gives a study on elastic property of jointed rock with crystalline structure. Firstly, an algorithm based on modified constraint centroid Voronoi tessellation is proposed to generate jointed rock mass with periodical structure according to the site features. Then, numerical homogenization method is implemented to analyze the equivalent homogeneous properties based on an anisotropic hypothesis, and the result is validated by the in-situ test. Finally, we discuss the influence of different joint parameters on homogenized properties. The results indicate that elastic modulus decreases and Poisson's ratio decreases with the aperture. Both elastic modulus and Poisson's ratio decrease with the increasing joint density. With the increase of maturity, elastic modulus has an increasing tendency, while Poisson's ratio changes conversely. Jointed rock has obvious scale effect and can be treated as isotropic media when the size is big enough.

The topics of the conference are:

- Reservoir mechanics (Nuclear waste disposal, CO<sub>2</sub> sequestration, Energy storage, Petroleum engineering, Geothermal energy etc.)

**Instructions:** Columnar basalt, filled with crystalline structural joints, is often encountered in hydropower station project in the south western of China, such as Baihetan, Jinanqiao and Guandi. Compared with disturbed rock, it has poor structure but better mechanics performance. Large amount volume indicates that it is not economically wise to excavation and remove it clearly. As a result, its strength and

---

<sup>1</sup>China Research Institute of Geotechnical Engineering, Hohai University, Nanjing 210098, China, wyxu@hhu.edu.cn

<sup>2</sup>China Research Institute of Geotechnical Engineering, Hohai University, Nanjing 210098, China, tianyameng@hhu.edu.cn

<sup>3</sup>Key Laboratory of Coastal Disaster and Defense, Ministry of Education, Hohai University, Nanjing 210098, wanghuanling@hhu.edu.cn

<sup>4</sup>Jiangsu transportation institute, Nanjing 211112, China, hm@jsti.com

deformation parameters estimation always occupies an important position in geological survey and design of hydropower engineering.

The basic feature of columnar basalt is randomly or uniformly arranged crystals shown in Fig. 1. As for the generation of rock mass of this type, there are two methods, one is Mosaic Tessellation (Stoyan, et al., 1995) and another is Voronoi Tessellation (Budkewitsch and Robin, 1994; Cílek 2015; Dershowitz and Einstein, 1998). In this study, based on the idea of Lloyd's iteration and bisection method, a modified constraint centroid Voronoi method is proposed.

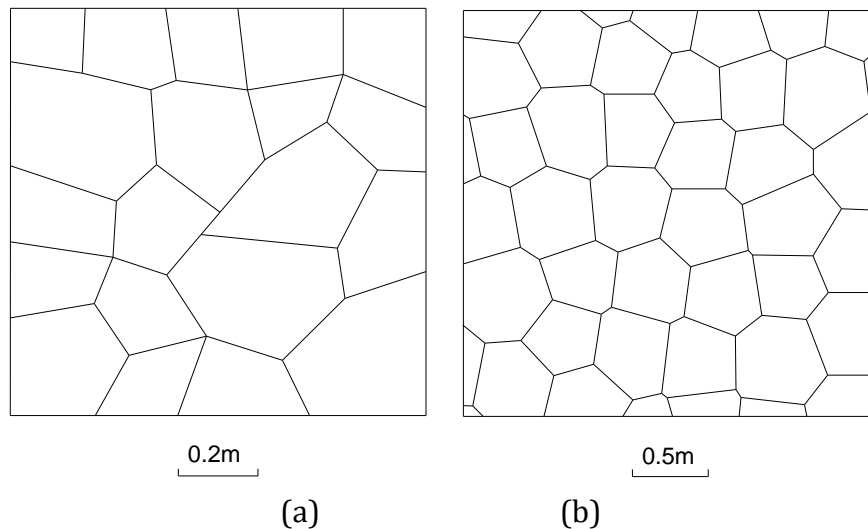

Figure 1. The joint arrangement of jointed rock with Crystalline structure: (a) Baihetan hydropower station and (b) Giant's Causeway.

As for the homogenized property of jointed rock, periodical structure is preferable due to the implementation convenience of periodical boundary conditions. An idea for the generation of polycrystalline material is employed in this paper.

With the development in mechanics of composite materials, numerical homogenization has become a powerful tool in analysis of heterogeneous material. Numerical homogenization is employed to link the gap between macro and micro problem. The analysis of micro scale analysis must satisfy the deformation compatibility and stress continuity of macro scale analysis. Therefore, the periodical boundary which can meet this requirement is widely used in the analysis of unit cell. Based on the elastic parameters of different composites of rock mass and periodic boundary condition, numerical analysis is done.

## References

- Stoyan, D., Kendall, W., and J. Mecke (1995), *Stochastic geometry and its applications*, Akademie-Verlag, Berlin.
- Budkewitsch, P., and P.Y., Robin (1994), Modelling the evolution of columnar joints. *Journal of Volcanology and Geothermal Research*, 59, 219-39.
- Cílek, V., Adamovič, J., and L., Suková (2015), Sandstone columns of the 3rd Nile Cataract (Nubia, Northern Sudan). *Zeitschrift für Geomorphologie, Supplementary Issues*, 59, 151-63.
- Dershowitz, W.S., and H.H., Einstein (1988), Characterizing rock joint geometry with joint system models. *Rock Mechanics and Rock Engineering*, 21, 21-51.



# Author Index

- Abbassi Fethi, 54, 55  
Agofack Nicolaine, 126, 127  
Aharonov Einat, 40, 41  
Alevizos Sotiris, 6, 7, 110, 111  
Alvarello Iglesias José, 70, 71  
Amitrano David, 30, 31  
Armand Gilles, 150, 151
- Barnichon Jean Dominique, 90, 91  
Basarir Hakan, 54, 55  
Belmokhtar Malik, 8, 9  
Berre Inga, 142, 143  
Bertrand Francois, 10, 11  
Bhat Harsha, 96, 97, 118, 119  
Billaux Daniel, 94, 95  
Blöcher Guido, 16, 17, 50, 51  
Blum Philipp, 56, 57  
Bornert Michel, 12, 13  
Boussange Victor, 6, 7, 110, 111  
Brochard Laurent, 12, 13  
Brown Julie, 86, 87  
Bruel Dominique, 82, 83  
Buzzi Olivier, 10, 11
- Cacace Mauro, 16, 17, 50, 51  
Camusso Marco, 94, 95  
Cao Yajun, 14, 15  
Cappa Frédéric, 34, 35, 122, 123  
Carmeliet Jan, 26, 27  
Carrera Jesús, 22, 23, 38, 39  
Carrier Aurore, 30, 31  
Castilla Raymi, 66, 67  
Chareyre Bruno, 102, 103  
Chen Chong-Feng, 156, 157  
Chen Jianye, 18, 19  
Choens Robert, 24, 25  
Collin Frédéric, 10, 11, 146, 147  
Conil Nathalie, 8, 9, 74, 75, 150, 151  
Couples Gary, 20, 21  
Cui Yujun, 94, 95
- Dano Christophe, 146, 147  
Darcel Caroline, 34, 35  
Dautriat Jeremie, 58, 59  
De Simone Silvia, 22, 23, 38, 39
- Delage Pierre, 8, 9, 74, 75  
Delei Shang, 164, 165  
Delgado Martín Jordi, 70, 71  
Deon Fiorenza, 16, 17, 50, 51  
Dewers Thomas, 24, 25  
Dimier Alain, 160, 161  
Ding Xiuli, 158, 159  
Donze Frederic, 66, 67, 102, 103  
Dorostkar Omid, 26, 27  
Driesner Thomas, 76, 77
- Ebigbo Anozie, 60, 61  
El Youssofi Moulay Saïd, 48, 49  
Elchalakani Mohamed, 54, 55  
Enzmann Frieder, 56, 57  
Escobar Álvarez Elena, 70, 71
- Farhat Faten, 28, 29  
Francois Bertrand, 100, 101  
Friedli Balz, 136, 137
- Gómez Castro Berta María, 38, 39  
Gabis Ben, 24, 25  
Garagash Dmitry, 32, 33  
Garnier André, 126, 127  
Gens Antonio, 120, 121  
Ghabezloo Siavash, 8, 9, 12, 13, 126, 127  
Ghazal Rima, 34, 35  
Ghazi Mirsaeed Seyed Mahdi, 98, 99  
Goicolea José, 70, 71  
Golovin Sergey, 36, 37  
Gong Chuangen, 152, 153  
Got Jean-Luc, 30, 31  
Gotteland Philippe, 146, 147  
Gout Claude, 66, 67  
Guangzhi Yin, 164, 165  
Guglielmi Yves, 34, 35, 122, 123  
Guyer Robert, 26, 27
- Hazzard Jim, 34, 35  
Heap Michael, 156, 157  
Herod Matt, 86–89  
Holtzman Ran, 40, 41  
Holzbecher Ekkehard, 42, 43  
Honorio Tulio, 12, 13

Hu Manman, 44, 45  
 Hu Mengsu, 46, 47  
 Huang Shuling, 158, 159  
 Huanling Wang, 168, 169  
 Hueckel Tomasz, 48, 49  
 Huenges Ernst, 16, 17  
  
 Jacquy Antoine, 16, 17, 50, 51  
 Jansen Gunnar, 52, 53  
 Jeanne Pierre, 122, 123  
 Johnson Paul A., 26, 27  
 Jouanne François, 30, 31  
  
 Karrech Ali, 54, 55  
 Katz Oded, 40, 41  
 Keilegavlen Eirik, 142, 143  
 Khalili Nasser, 144, 145  
 Khoei Amir, 144, 145  
 Kling Tobias, 56, 57  
 Klinger Yann, 96, 97  
 Kohl Thomas, 128, 129  
 Kotronis Panagiotis, 146, 147  
  
 Leal Allan, 60, 61  
 Lecampion Brice, 32, 33, 78, 79  
 Lesueur Martin, 62, 63, 110, 111, 128, 129  
 Li Bo, 64, 65  
 Li Xiangling, 94, 95  
 Li Zhenze, 86–91  
 Liu Dong, 32, 33  
 Liu Jie, 58, 59  
 Liu Richeng, 64, 65  
  
 Mánica Miguel, 120, 121  
 Macchi Edoardo, 84, 85  
 Madariaga Raul, 118, 119  
 Maghsoodi Soheib, 66, 67  
 Makhnenko Roman, 68, 69, 148, 149  
 Marone Chris, 26, 27  
 Marsan David, 30, 31  
 Martin Ruiz Miriam, 70, 71  
 Mazzoldi Alberto, 122, 123  
 Medetbekova Maiya, 72, 73  
 Menaceur Hamza, 74, 75  
 Meng Qingxiang, 162, 163, 166–169  
 Miao He, 170, 171  
 Mielniczuk Boleslaw, 48, 49  
 Miller Stephen, 52, 53  
 Milsch Harald, 16, 17, 50, 51  
 Mindel Julian, 76, 77  
 Minghui Li, 164, 165  
 Mohr-Durdez Theophile, 6, 7  
 Moukhtari Fatima-Ezzahra, 78, 79  
  
 Najari Meysam, 130, 131  
 Nejati Morteza, 80, 81  
 Ngo Dac-Thuong, 82, 83  
 Nguyen Denis, 84, 85  
 Nguyen Son, 86–91  
 Nguyen Van Tri, 92, 93  
 Nguyen Xuan-Phu, 94, 95  
 Nick Hamid, 72, 73, 124, 125  
 Niemeijer Andre, 18, 19  
  
 Okubo Kurama, 96, 97  
 Oliaei Mohammad, 98, 99  
  
 Papachristos Efthymios, 102, 103  
 Papamichos Euripides, 104, 105  
 Papanastasiou Panos, 106, 107  
 Peigney Michael, 12, 13  
 Pellet Frederic, 82, 83  
 Pereira Jean-Michel, 92, 93  
 Peters Max, 108, 109, 128, 129  
 Ping Chen, 140, 141  
 Podladchikov Yury, 68, 69  
 Poncelet Nicolas, 100, 101  
 Poulet Thomas, 6, 7, 62, 63, 108–115  
 Pourpak Hamid, 28, 29  
 Puzrin Alexander, 136, 137  
  
 Raof Amir, 154, 155  
 Rattez Hadrien, 112–115, 134, 135, 138, 139  
 Regenauer-Lieb Klaus, 6, 7, 44, 45, 58, 59, 108, 109, 116, 117  
 Rinaldi Antonio, 122, 123  
 Romanet Pierre, 118, 119  
 Rougier Esteban, 96, 97  
 Ruiz Daniel, 120, 121  
 Rutqvist Jonny, 46, 47, 122, 123  
  
 Saar Martin, 60, 61  
 Salimzadeh Saeed, 72, 73, 124, 125  
 Samudio Marcos, 126, 127  
 Sarout Joel, 58, 59  
 Scheck-Wenderoth Magdalena, 16, 17  
 Scholtes Luc, 102, 103  
 Schwarz Jens-Oliver, 56, 57  
 Seibi Abdennour, 54, 55  
 Seithel Robin, 128, 129  
 Selvadurai A.p.s., 130, 131  
 Seyedi Darius, 150, 151  
 Shao Jian-Fu, 28, 29, 132, 133  
 Shao Jianfu, 14, 15  
 Shen Wanqing, 14, 15, 28, 29  
 Song Zhenlong, 164, 165  
 Spiers Chris, 154, 155

Stefanou Ioannis, 12, 13, 112–115, 134, 135,  
138, 139  
Stoecklin Andreas, 136, 137  
Su Grant, 88–91  
Sulem Jean, 112–115, 126, 127, 134, 135, 138,  
139  
  
Tang Anh Minh, 92, 93  
Tang Anh-Minh, 74, 75, 94, 95  
Tauveron Nicolas, 84, 85  
Tianshou Ma, 140, 141  
Tianya Meng, 170, 171  
Torkaman Mahboubeh, 98, 99  
Tran-Manh Huy, 34, 35  
Tung Rebecca, 110, 111  
  
Ucar Eren, 142, 143  
Urbanczyk Christophe, 126, 127  
Urpi Luca, 122, 123  
  
Vahab Mohammad, 144, 145  
Vaknin Inbar, 40, 41  
Vandamme Matthieu, 12, 13  
Vasilescu Andreea, 146, 147  
Vaunat Jean, 120, 121  
Veveakis Manolis, 6, 7, 44, 45, 58, 59, 62, 63,  
108–115  
Vilarrasa Victor, 22, 23, 122, 123, 148, 149  
Vitel Manon, 150, 151  
Vogförd Kristin, 30, 31  
  
Walle Lars, 104, 105  
Wang Huanling, 162, 163, 166, 167, 170, 171  
Wang Rubin, 152, 153, 166, 167  
Wang Wei, 152, 153  
Wendler Frank, 56, 57  
Wheeler Mary, 24, 25  
Wolterbeek Tim, 154, 155  
  
Xu Tao, 156, 157  
Xu Weiya, 152, 153, 162, 163, 166–171  
  
Zhang Minchao, 58, 59  
Zhang Yuting, 158, 159  
Zhong Zhen, 64, 65  
Zhou G.l., 156, 157



# GEOPROC 2017



Organized by:



IFSTTAR



Sponsored by:



LABEX MMCD



ISRM



CFMR