



HAL
open science

Composants de Façades à Hautes Performances Énergétiques, un avenir pour les matériaux composites

Jean-François Caron

► **To cite this version:**

Jean-François Caron. Composants de Façades à Hautes Performances Énergétiques, un avenir pour les matériaux composites. ORGAGEC 2015 Rénovation de la ville, les matériaux organiques dans l'enveloppe du bâtiment., Ifsttar, Nov 2015, Champs-sur-Marne, France. hal-01249131

HAL Id: hal-01249131

<https://enpc.hal.science/hal-01249131>

Submitted on 30 Dec 2015

HAL is a multi-disciplinary open access archive for the deposit and dissemination of scientific research documents, whether they are published or not. The documents may come from teaching and research institutions in France or abroad, or from public or private research centers.

L'archive ouverte pluridisciplinaire **HAL**, est destinée au dépôt et à la diffusion de documents scientifiques de niveau recherche, publiés ou non, émanant des établissements d'enseignement et de recherche français ou étrangers, des laboratoires publics ou privés.



Distributed under a Creative Commons Attribution 4.0 International License



Composants de Façades à Hautes Performances Énergétiques, Un avenir pour les matériaux composites.

Jean-François CARON

UMR Navier Ecole des Ponts ParisTech

Ecole des Ponts ParisTech

IFSTTAR (ex LCPC/INRETS)



Cité Descartes Champs sur Marne

Orgagec15 - nov.2015

Composites

É Propriétés mécaniques:

- rigidité et résistance élevées combinés à une faible densité
- grande résistance à la fatigue et à la corrosion
- haute résistance aux influences des produits chimiques
- stabilité du dimensionnement
- Faible conductivité thermique

É Fonctionnalités:

- préfabrication haut de gamme en usine
- finitions de surface sur mesure
- possibilité d'intégration de fonctions

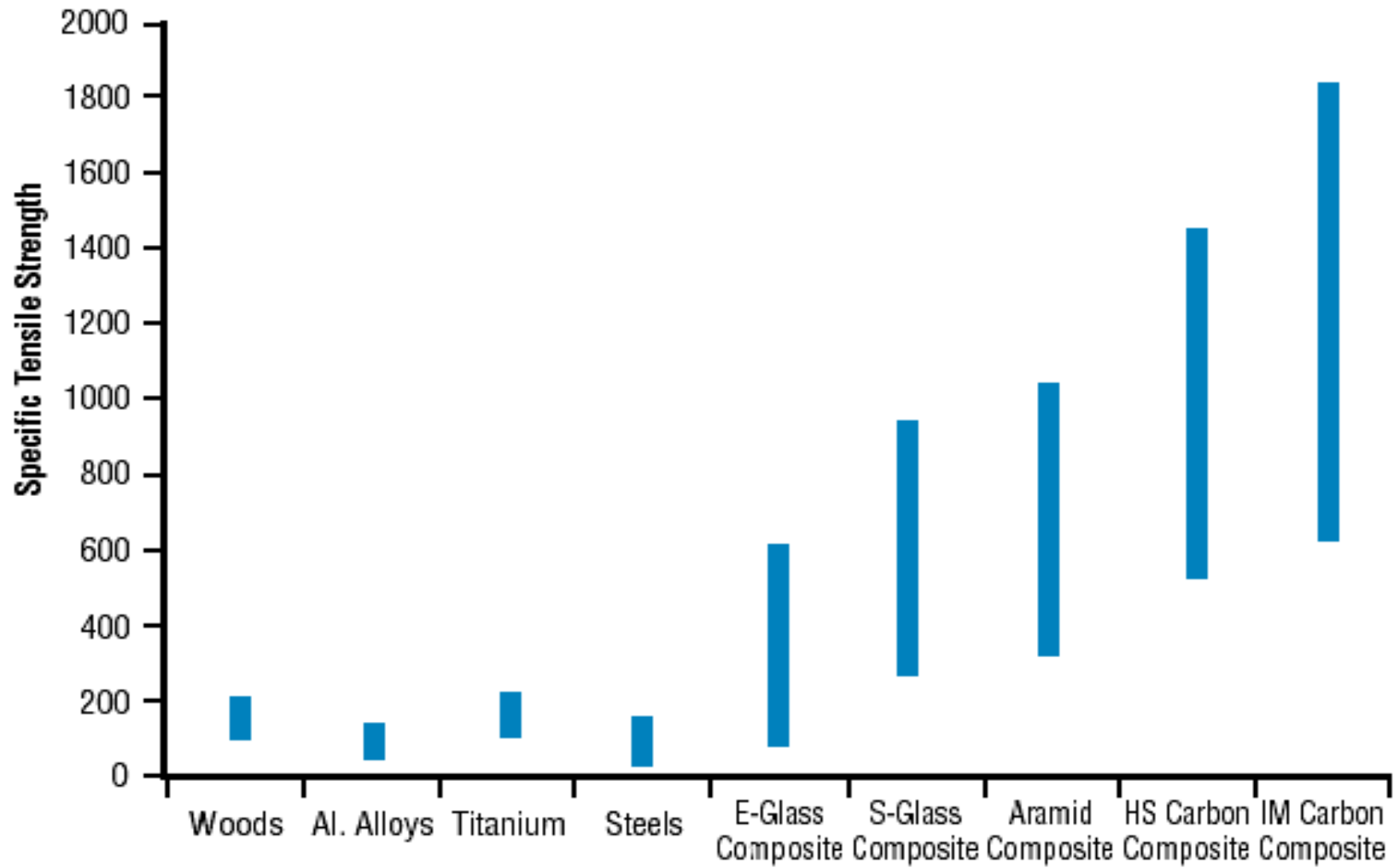

Specific Tensile Strength of Common Structural Materials

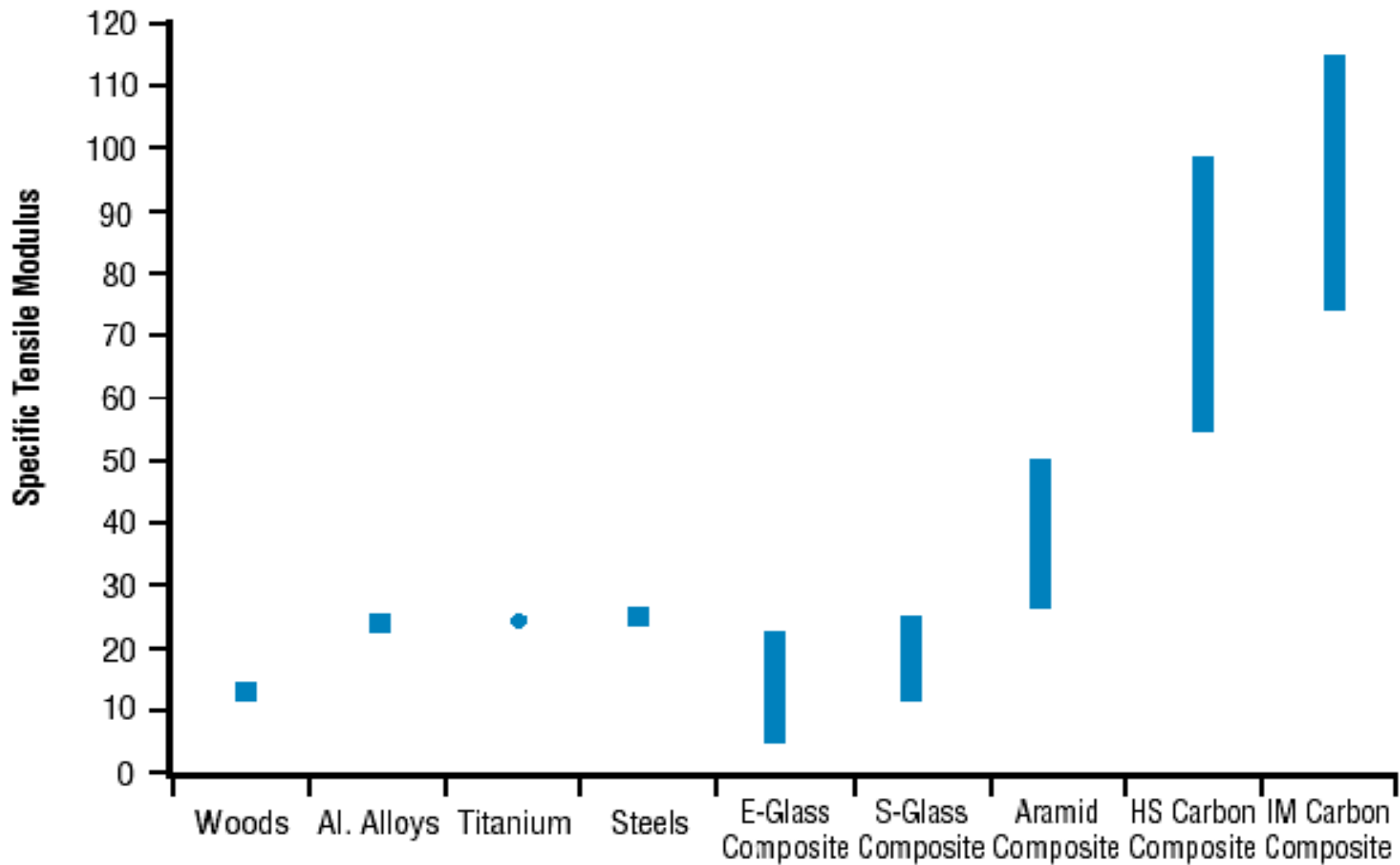

Specific Tensile Modulus of Common Structural Materials

Composites pour la construction,

des atouts, des écueils



Les moteurs actuels

- “ Légèreté
- “ Design, richesse formelle
- “ Préfabrication
- “ Résistance corrosion
- “ Souplesse + résistance
- “ Comportement thermique



Quelques freins et verrous restants

- + Normes et réglementations
- + Durabilité
- + Calcul
- + Innovations en rupture

- « Les classiques »: feu, environnement, prix



Orgagec15 - nov.2015

Focus Thermique



- “ With 40% of our energy consumed in buildings, the EU has introduced legislation to ensure that they consume less energy*.
- “ New European thermal insulation regulations for building envelopes are becoming stricter and stricter (RT 2005 . 2012 . 2020^o),
- “ Thermal insulation of the façade components represents the best way to lower energetic needs of buildings
- “ Target= new and old buildings (below 10 floor levels).
- “ [*http://www.epbd-ca.eu/](http://www.epbd-ca.eu/); Concerted Action Energy Performance of Building

Focus Thermique



Profilé Aluminium :

Conductivité thermique 1 200W/m.K

Profilé Composite :

Conductivité thermique 1 0.3W/m.K

Focus Thermique



2008

TopGlass/Solutions
Composites



2006

TopGlass/Solutions composites, IDA,
Isover, Saint Gobain, Lapeyre,
Terrealõ Ademe,

COFAHE

Composants de Façades à Hautes Performances Energétiques



*Source: GARNIER G. COFAHE2 : Composants de Façades à Hautes Performances Energétiques, Phase 2, CSTB, Juillet 2012,202 pages.

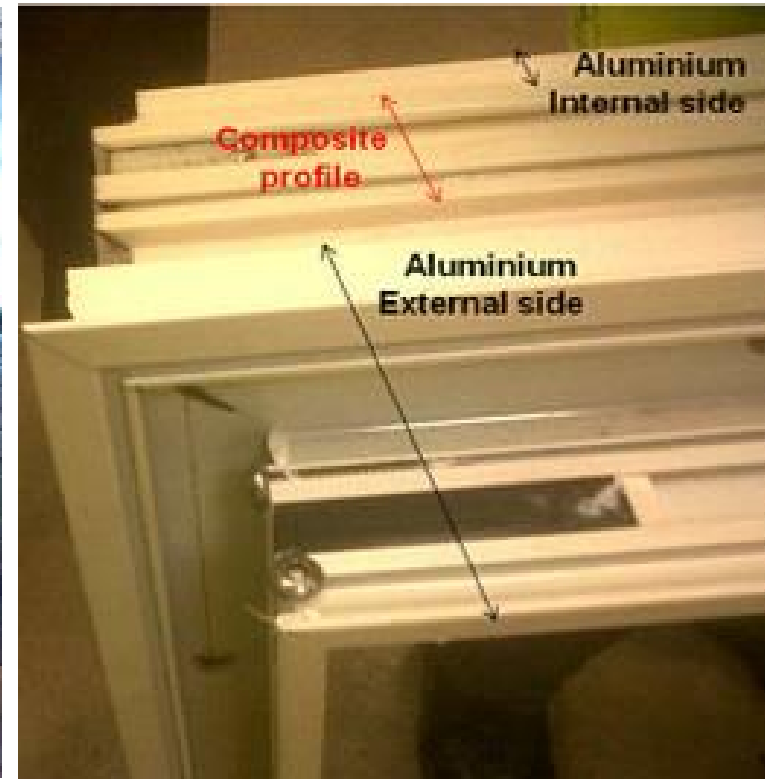

Projet ADEME, COFAHE (CSTB, Goyer, Compositec, Owens Corning, Exel, Navier - 2012)

“Cadres pultrudés, géométrie complexe

“Panneaux sandwich optimisés

“Matériaux à changement de phase (Energain®, Du Pont de Nemours)

“Isolants sous vide (Vacupor NT-B2, Porextherm)

“Conception intégrée

Orgagec15 - nov.2015

” Panneaux de remplissage:

- Alu + profilé composite profile ¹
- 55mm panneaux isolés sous vide
- ciment renforcé fibre de verre ²

¹ XStrand® H high modulus glass, Owens Corning

² Cem-FIL AR glass, Owens Corning

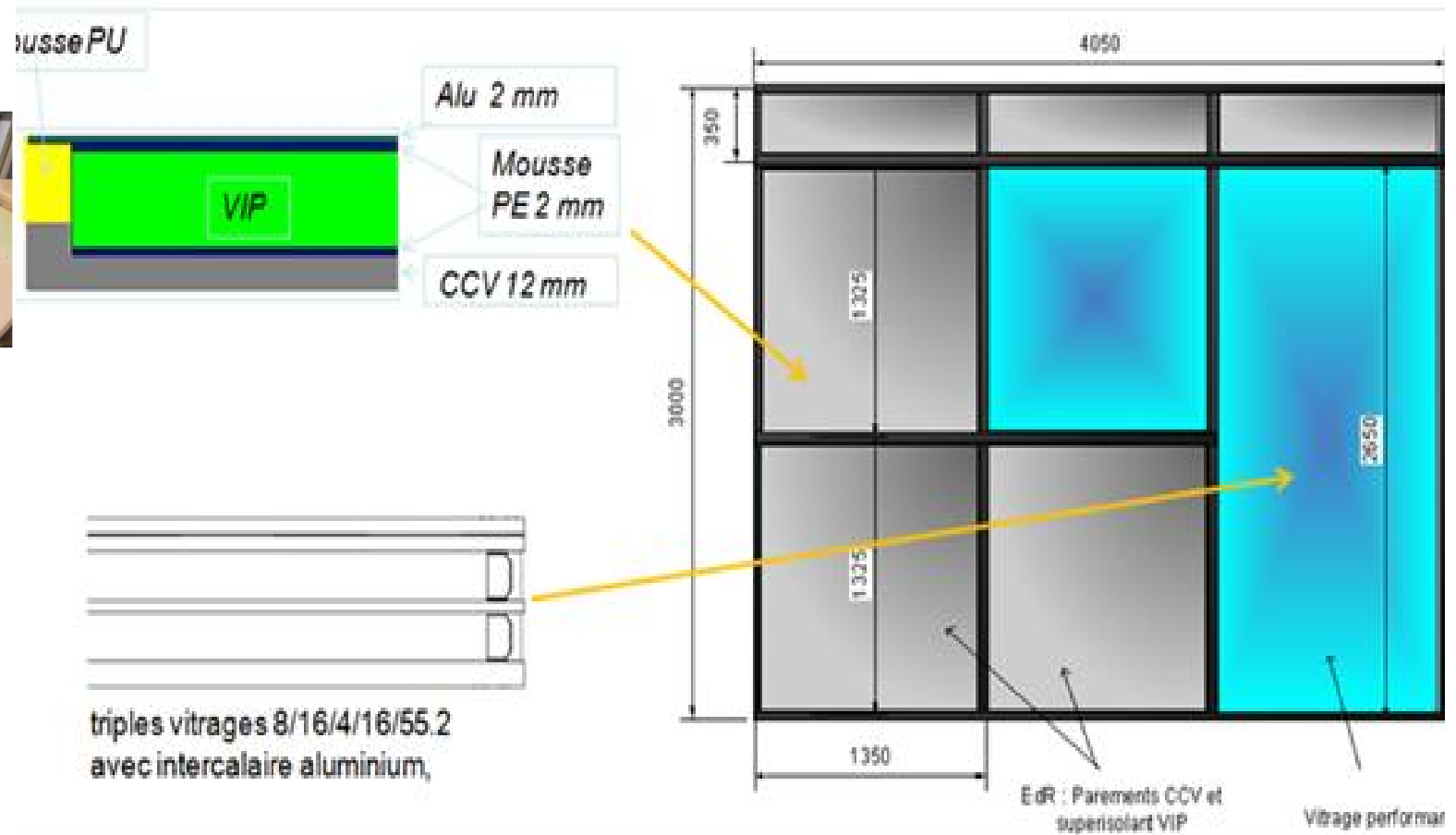
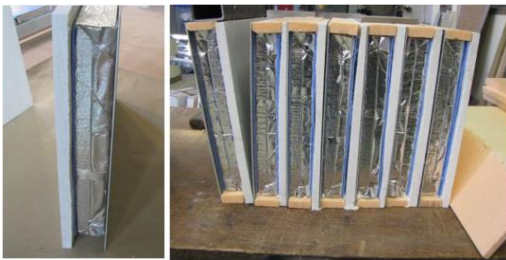

” Triple vitrage

Le profilé composite

Pultrusion

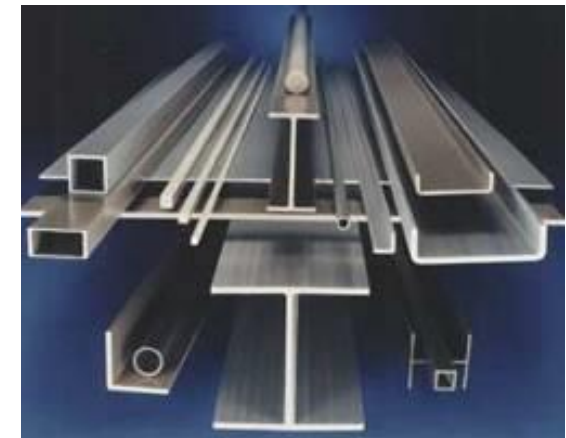
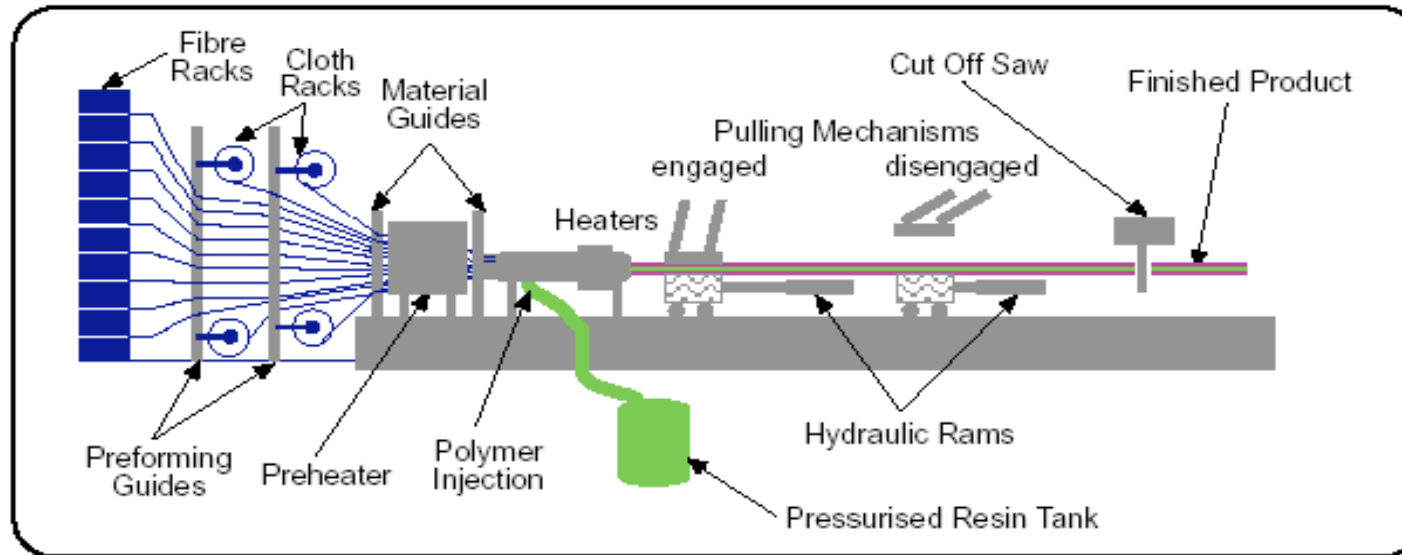

ÉFormage de profilés

ÉFibres dans l'axe

É« au km » = prix bas

Épolymérisation en température

É70% taux de fibre

É0.5 à 3m / min

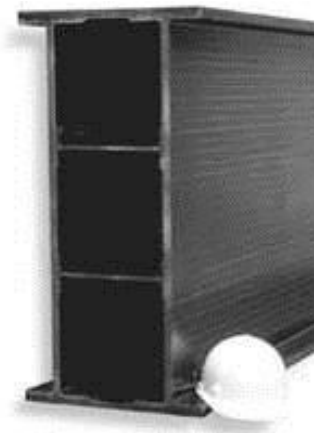

Le profilé composite

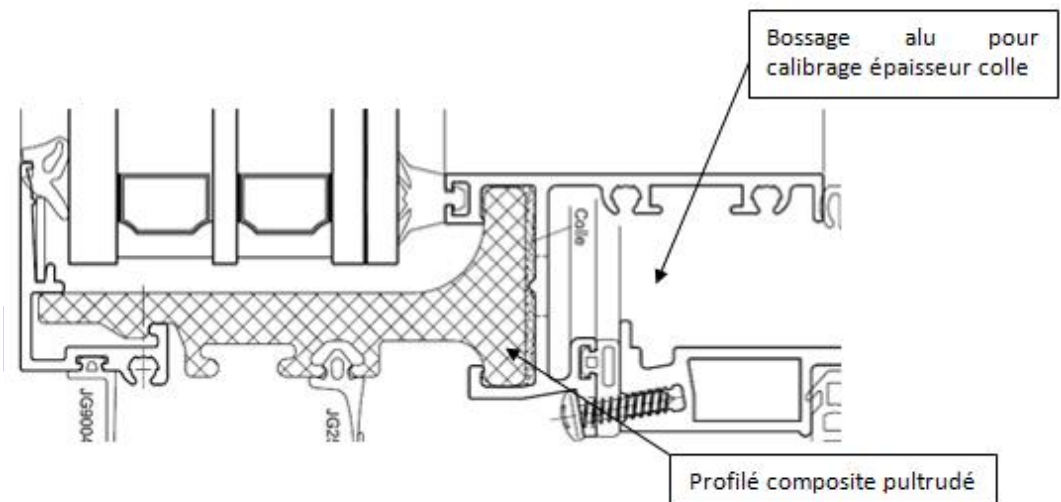
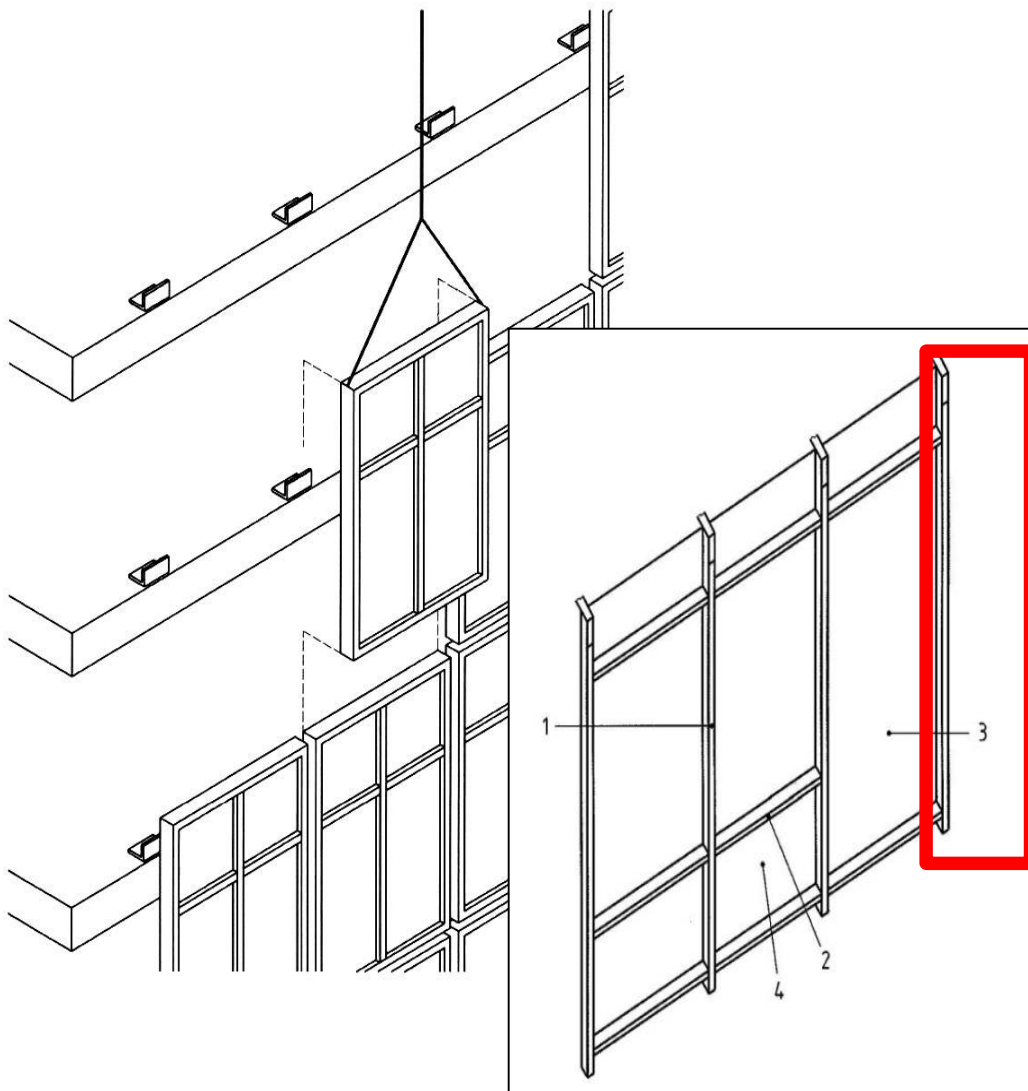

Le profilé composite

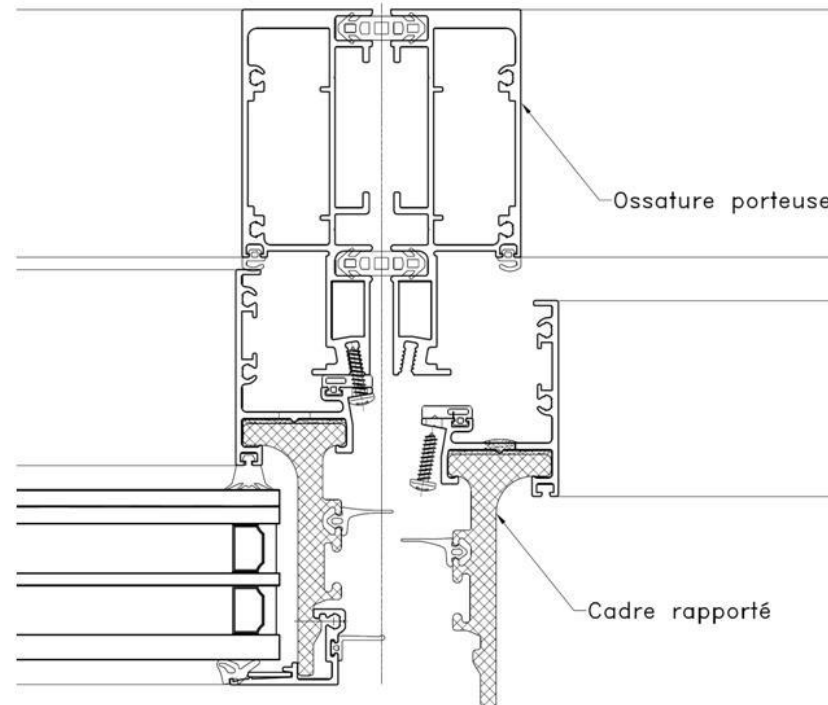
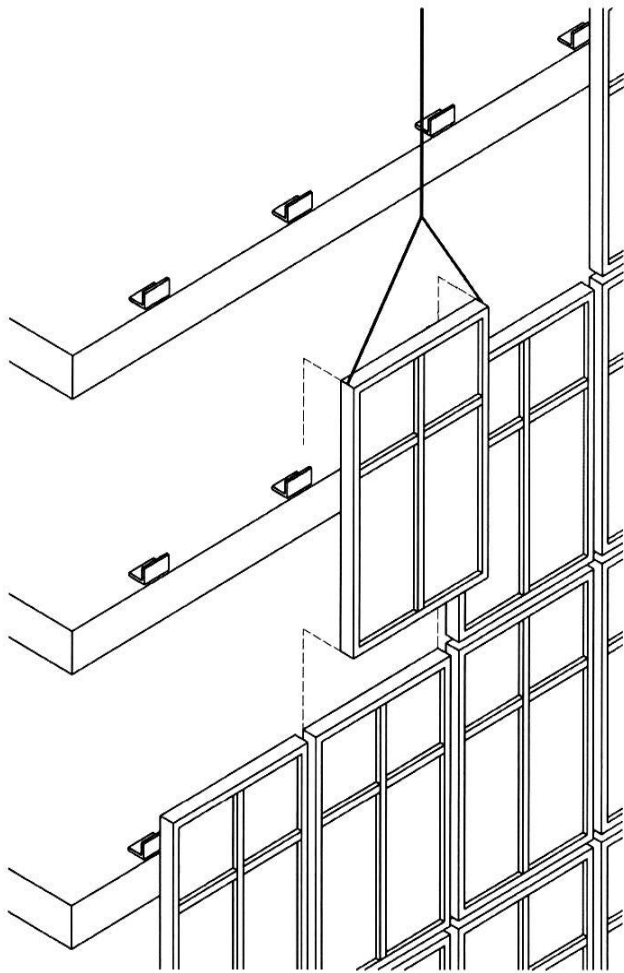

Validations mécaniques

Pression du vent

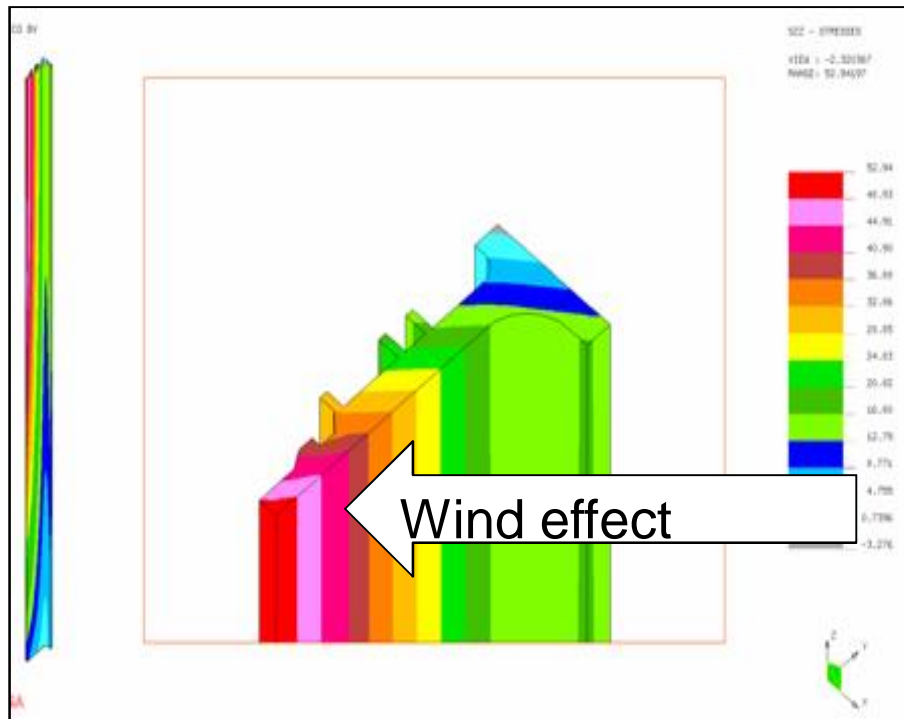

Masse
panneau

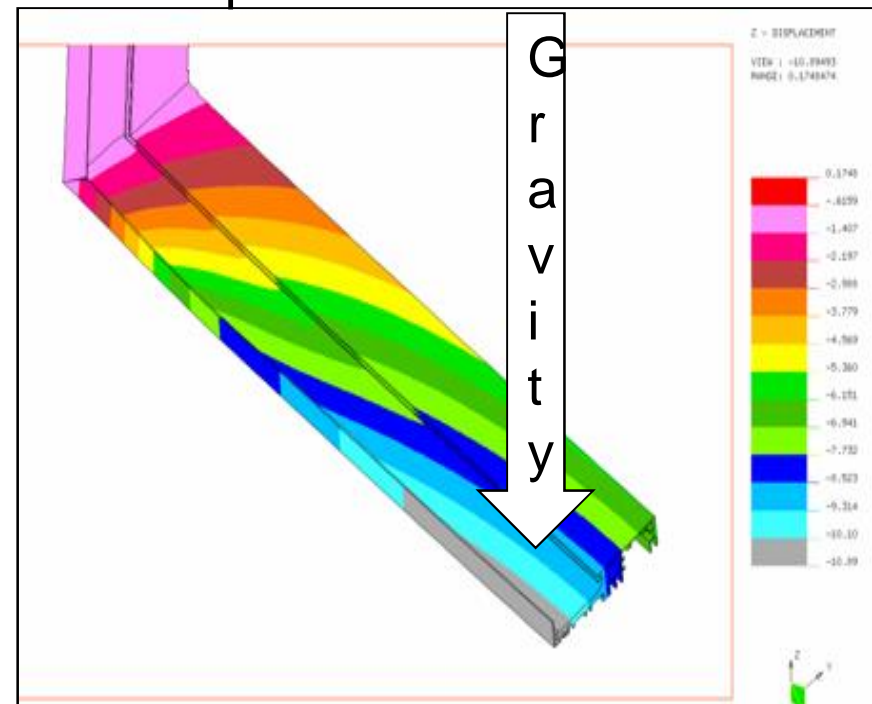

Tests

- ” Chocs
- ” Perméabilité à l'air
- ” Perméabilité à l'eau
- ” Déformation au vent

Ok



Profils pultrudés à base de résine vinylester:

Sans additifs

Avec additifs

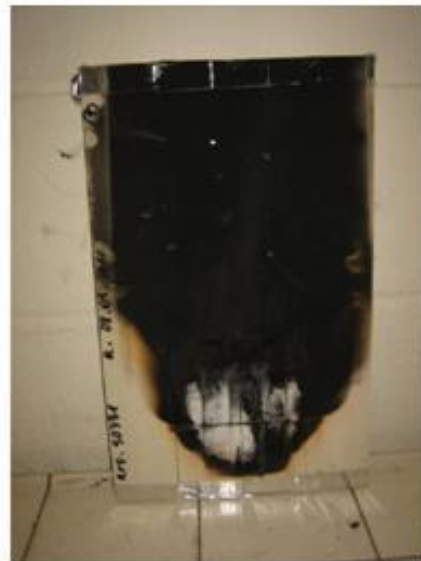

Avant test

Après test

Avant test

Après test

Classement au feu : \Rightarrow M2

Classement au feu : \Rightarrow M1

Performances et coûts comparés

- “ Recommandations RT 2005 :
coefficient de transmission surfacique U surface (W/ m².K) < 2.3
La solution COFAHE propose un U=0.85 W/ m².K
- “ Panneaux COFAHE 30% plus chers
- “ 80% des surcoûts dus à des opérations d'assemblage
Marge pour une optimisation
- “ Les composites évitent les rupteurs thermiques et économisent de l'énergie (5 à 12% besoin chauffage)

Merci pour votre attention



COFAHE

ADEME, CSTB, Goyer, Compositec, Owens Corning, Exel, Navier