



**HAL**  
open science

## A comparative study on the hydro-mechanical behaviour of compacted bentonite/sand plug based on laboratory and field infiltration tests

Qiong Wang, Anh Minh A.M. Tang, Yu-Jun Cui, Jean-Dominique Barnichon, Wei-Min Ye

### ► To cite this version:

Qiong Wang, Anh Minh A.M. Tang, Yu-Jun Cui, Jean-Dominique Barnichon, Wei-Min Ye. A comparative study on the hydro-mechanical behaviour of compacted bentonite/sand plug based on laboratory and field infiltration tests. *Engineering Geology*, 2013, 162, pp.79-87. 10.1016/j.enggeo.2013.05.009 . hal-00926865

**HAL Id: hal-00926865**

**<https://enpc.hal.science/hal-00926865>**

Submitted on 26 Apr 2018

**HAL** is a multi-disciplinary open access archive for the deposit and dissemination of scientific research documents, whether they are published or not. The documents may come from teaching and research institutions in France or abroad, or from public or private research centers.

L'archive ouverte pluridisciplinaire **HAL**, est destinée au dépôt et à la diffusion de documents scientifiques de niveau recherche, publiés ou non, émanant des établissements d'enseignement et de recherche français ou étrangers, des laboratoires publics ou privés.



27 **Abstract:** SEALEX is a research project aiming at identifying the key factors that  
28 affect the long-term performance of bentonite-based sealing systems with an initial  
29 technological void. In this context, a series of in-situ experiments have been being  
30 performed in field conditions. Meanwhile, a small scale test (1/10) was carried out in  
31 controlled conditions in the laboratory, aiming at providing useful information for  
32 analyzing the in-situ tests in terms of saturation time and sealing effectiveness. In this  
33 paper, the results of the small-scale test are presented along with the results from the  
34 first in-situ test (PT-N1). It was observed that during the saturation process, the  
35 evolution of the injected water volume followed a hyperbolic relationship with time in  
36 both the laboratory and field conditions. In the laboratory conditions, a decrease in  
37 axial swelling pressure occurred due to filling of the technological void. By contrast,  
38 this decrease has not been observed in the field conditions. Comparison of the injected  
39 water and the axial swelling pressure between the two different scales enabled the  
40 definition of a same time up-scaling ratio of 2.5 (in situ experiment /small scale test).  
41 Accordingly, the saturation duration of the in situ experiment was estimated to be  
42 equal to two years. For the small-scale test, a swelling strain evolution rate of 0.588  
43 mm/day was identified in the case of infiltration from two sides of the sample. This is  
44 useful when predicting the evolution of swelling strain in the case of failure of the  
45 sealing plug. After filling of an additional 20% void, a swelling pressure of 0.18 MPa  
46 was obtained, indicating the favorable sealing capacity of the material after filling the  
47 technological void.

48 **Keywords:** small-scale test; in-situ experiment; bentonite/sand mixture; technological

49 void; swelling pressure; swelling stain.

## 50 **1 INTRODUCTION**

51 In the design of deep geological repository for high level long lived radioactive wastes,  
52 compacted bentonite-based materials are often considered as buffer/sealing materials.  
53 These materials are expected to exhibit a swelling pressure high enough to fulfil their  
54 buffer/sealing functions.

55 Numerous laboratory studies have been conducted to assess the performance of  
56 buffer/sealing materials (e.g. Delage et al., 1998; Lloret et al., 2003; Romero et al.,  
57 2005; Lloret & Villar, 2007). Various experiments were also performed in the  
58 underground research laboratories (URL) (TSX at Manitoba, Canada; FEBEX at  
59 Grimsel, Switzerland; RESEAL at Mol, Belgium; KEY at Bure, France, etc.).  
60 Recently, IRSN (Institut de Radioprotection et de Sûreté Nucléaire, France) has  
61 launched the SEALEX project aiming at identifying and quantifying the key factors  
62 related to the long-term performance of bentonite-based sealing systems taking into  
63 account an initial technological void. This project consists of a series of in-situ  
64 experiments in the Tournemire URL, and a small-scale test (1/10) in the laboratory.

65 The in-situ experimental program was purposefully built allowing systematical  
66 exploration of the effects of technical specifications, design, construction, defect, etc.,  
67 by changing a single parameter each time. As a reference case (see Barnichon et al.  
68 2009, 2012 for more details), the first test PT-N1 with a clay core made up of  
69 pre-compacted monolithic disks of MX80 bentonite/sand mixture (70/30 in dry mass)

70 has been conducted in the URL of Tournemire. Due to the low permeability of this  
71 material, saturation is expected to be reached in several years (see Barnichon et al.,  
72 2012). During the saturation process, the injected water volume, total pressure, pore  
73 water pressure and relative humidity changes have been monitored at several  
74 positions within the plug. After the saturation stage, hydraulic tests will be performed  
75 to determine the overall hydraulic properties (permeability, occurrence of leakage) of  
76 the sealing system. In addition to this reference case, three other tests are designed to  
77 quantify the impact of the technical specification and design of the sealing plug by  
78 changing the intra-core geometry (jointed in stead of monolithic disks), core  
79 composition (MX80/sand ratio) and core conditions (compacted in field in stead of  
80 pre-compacted). Moreover, to investigate the effect of altered conditions, an  
81 additional test is designed to simulate an incidental decrease of swelling pressure  
82 caused by failure of the confining structure.

83 Based on the design of the in-situ experiments, a laboratory small-scale test (1/10)  
84 was performed, focusing on the recovery capacity of the bentonite-based seal with  
85 technological voids. The material identical to that used in test PT-N1 was used (MX80  
86 bentonite/sand mixture). A confining cell of stainless steel was used to simulate the  
87 constant-volume boundary conditions. After the initial saturation process as in the  
88 PT-N1 in-situ experiment, the seal evolution upon a confinement failure was  
89 simulated by allowing a given amount of free swell. This free swell was followed by a  
90 last stage of wetting under constant volume conditions. To assess the sealing capacity,  
91 the injected water volume, axial swelling pressure and swelling strain were monitored

92 in different stages. It was expected to obtain useful information from the laboratory  
93 small-scale test for analysing the field tests in terms of saturation time and sealing  
94 effectiveness.

95 In this paper, the results of the small scale test are presented along with the results  
96 from the in-situ test (PT-N1). An up-scaling ratio was obtained by comparing the  
97 injected water volume and the axial swelling pressure evolution between the  
98 laboratory and field conditions. The time needed to reach the stabilization of axial  
99 swelling pressure for the in situ test (PT-N1) as well as the evolution of swelling strain  
100 and swelling pressure in the case of failure of the confining structure were estimated  
101 accordingly.

## 102 **2 MATERIALS AND METHODS**

### 103 **2.1 Materials**

104 The soil studied is a compacted MX80/sand mixture with a proportion of 70/30 in dry  
105 mass. The bentonite is from Wyoming, USA, with a high content of montmorillonite  
106 (80%). It has a liquid limit of 575%, a plastic limit of 53% and a unit mass of  
107  $2.77 \text{ Mg/m}^3$ . The cation exchange capacity (CEC) is 76 meq/100g (83 % of  $\text{Na}^+$ ). The  
108 quartz sand used in the mixture comes from Eure and Loire (France) with a unit mass  
109 of  $2.65 \text{ Mg/m}^3$ . It was sieved at 2 mm prior to being mixed with the bentonite.

110 The water used has the same chemical composition as the pore water of the  
111 Callovo-oxfordian claystone from the ANDRA URL in Bure (France), namely  
112 synthetic water (Wang et al., 2012a, 2012b). It was obtained by mixing the

113 corresponding chemical compounds (see Table 1) with distilled water using a  
114 magnetic stirrer until full dissolution.

## 115 **2.2 SEALEX in-situ test (PT-N1)**

116 As mentioned above, the in-situ experiment (PT-N1) has been conducted in the  
117 Tournemire Underground Research Laboratory excavated in Toarcian claystone. A  
118 horizontal borehole (0.60 m in diameter) was drilled for this purpose. Figure 1 shows  
119 the layout of the experiment. A seal made up of compacted MX80/sand mixture was  
120 sandwiched between two porous plates, allowing water inflow from two water  
121 reservoirs (i.e. upstream and downstream). The 14.33% annular technological void  
122 (volume of void/volume of borehole) was defined by adopting a smaller initial  
123 diameter (0.555 m) of the pre-compacted seal as compared to the borehole diameter  
124 (0.60 m). The upstream plate is in direct contact with the host-rock while the  
125 downstream one is retained by a confining system ensuring a constant-volume  
126 condition. A packer-like device was used to prevent water leakage from the interface  
127 between the confining plug and host-rock.

128 The clay seal in test PT-N1 is made up of 8 monolithic pre-compacted disks (0.555 m  
129 in diameter and 0.15 m thick) of MX80/sand mixture with an initial dry density of  
130  $1.97 \text{ Mg/m}^3$  (Figure 2). The disks were arranged in vertical slices giving rise to the  
131 geometry of seal as shown in Figure 2. The bricks were obtained through uniaxial  
132 compaction of the mixture at its initial water content of 11%. The initial dry density  
133 ( $1.97 \text{ Mg/m}^3$ ) of the bricks was selected based on the consideration of the 14.33 %  
134 technological void and the need to have a final dry density of  $1.67 \text{ Mg/m}^3$  after

135 saturation of the plug and filling of the initial technological voids.

136 Three types of sensors were installed within the compacted blocks to monitor the  
137 swelling pressure, pore pressure and relative humidity. For clarity, only the  
138 distribution of sensors for swelling pressure measurement is shown in this paper  
139 (Figure 3a). Three total pressure sensors were installed on the surface of the column at  
140 section 0.60 m (from the downstream saturation system, L-01, L-02, L-03) to measure  
141 the radial swelling pressure; two total pressure sensors were installed at section 0 and  
142 1.20 m to measure the axial swelling pressure (A-01, A-02). For each sensor, a hole as  
143 shown in Figure 3b was prepared at their pre-assigned positions before the  
144 assemblage of blocks, keeping the hole to a minimum size. Wireless sensors ( $d = 32$   
145 mm) were used to limit preferential flow along cables and a wireless transmitter was  
146 installed at each measurement section. Data were recorded automatically by a data  
147 acquisition system.

148 Regarding the test operational phases, a volume of water of 49 L was first injected,  
149 which corresponded to the volume of the technological void adopted. This process  
150 ended in one hour. Afterwards, the water supply was stopped because the side packer  
151 was not properly inflated; it restarted after 20 days under a water pressure of 0.1 MPa.  
152 During the saturation process, the swelling pressure, pore pressure, water content or  
153 water saturation within the plug were monitored. The injected water volumes at both  
154 upstream and downstream chambers were also measured. When the saturation process  
155 is completed, hydraulic tests will be performed to determine the overall hydraulic  
156 properties (permeability, occurrence of leakage) of the corresponding sealing systems.



### 157 **2.3 Laboratory small-scale test**

158 The experimental devices used for the laboratory small-scale test (1/10) are shown in  
159 Figure 4. A stainless steel cell of 60 mm in inner diameter and 200 mm long was used.  
160 As in the in-situ test, an annular technological void was defined by adopting a smaller  
161 initial diameter (55.5 mm) for the pre-compacted sample as compared to the diameter  
162 of the hydration cell (60 mm). Note however that the hydration cell was placed in the  
163 vertical direction (see Figure 4) and it was then different from the in-situ test which is  
164 performed in a horizontal borehole (see Figure 1 and Figure 2). Water supply was  
165 conducted through the water inlets in the bottom base which was connected to  
166 burettes. This allowed measurement of the total amount of water taken up by the  
167 sample. A piston of 60 mm diameter was used to simulate the confining structure. On  
168 the bottom of the piston, there was drainage with two inlets (upside inlet in Figure 4)  
169 and a porous stone of 50 mm diameter, allowing water/air flow. A mechanical press  
170 was used to restrain the axial deformation and a force transducer was used to monitor  
171 the axial swelling pressure. A displacement transducer fixed on the piston allowed  
172 monitoring of the axial displacement to an accuracy of 1  $\mu\text{m}$ . The axial pressure and  
173 axial displacement were recorded automatically to a data logger, while the inlet water  
174 volume was measured manually by determining the water level in the burettes. Note  
175 that in this small-scale test, the radial swelling pressure was not measured.

176 A monolithic cylindrical sample (55.5 mm in diameter, 120 mm high) was used in the  
177 test. It was statically compacted in a mould to the same dry density as in the in-situ  
178 test ( $1.97 \text{ Mg/m}^3$ ). In order to ensure the homogeneity of the specimen, the

179 compaction was carried out in two layers. The surface of the first compacted layer  
180 was carefully scarified before the second layer was added to ensure a good junction  
181 between them. Figure 5a shows the pre-compacted specimen with the hydration cell.  
182 After compaction, the specimen (55.5 mm in diameter) was placed at the center of the  
183 cell (60 mm in inner diameter), leaving an annular void (2.25 mm) between the  
184 specimen and cell wall (Figure 5b). An initial axial stress of 0.1 MPa was applied on  
185 the specimen before hydration in order to ensure good contacts between the load cell  
186 and the piston, between the piston and the sample, between the sample and the cell  
187 bottom, as well as satisfactory load measurement. Then, the upside inlets (see Figure  
188 4) were sealed and vacuum was applied to evacuate all air in the voids (technological  
189 void mainly). The synthetic water was finally injected from the bottom.

190 As described in Figure 6, hydration was carried out in three stages. First, the axial  
191 deformation was restrained and water was injected to the sample; during this stage  
192 (Stage 1. initial saturation phase), the evolution of the vertical swelling pressure was  
193 monitored. Once the hydration ended, the confining pressure in the axial direction was  
194 removed by unloading, allowing a free swell of 20% (Stage 2. recovery of the void  
195 phase). To reduce the test duration in this stage, two-side infiltration was applied by  
196 injecting water from both the bottom and the top, while recording changes in axial  
197 swelling strain over time. This stage aimed at simulating the case of a saturation  
198 defect or a failure of confining structure that may occur during the long-term lifespan  
199 of the disposal system. The free swell of 20% represents the sealing capacity required  
200 after filling the technological void. When the axial swelling strain reached the desired

201 value of 20%, the piston was automatically blocked thanks to a reserved distance of  
202 24 mm (corresponding to 20% swelling strain) between the piston and the load cell  
203 (Figure 7); the evolution of swelling pressure was monitored again (Stage 3.  
204 confinement phase).

## 205 **3 EXPERIMENTAL RESULTS**

### 206 **3.1 In situ test (PT-N1)**

207 Figure 8 shows the evolution of injected water volume over time. As mentioned above,  
208 a volume of 49 L was first injected to fill the technological void and the injection was  
209 stopped for 20 days due to a technical problem related to the packer. After resuming  
210 the injection, it was observed that the increase rate of water volume was followed by  
211 an asymptotic curve with a decreasing rate. After 367 days, the total injected water  
212 volume was 71.39 L (Figure 8). Examination of the curve shows that the shape of  
213 water volume versus time (after rejection) can be described by a hyperbolic function.  
214 Figure 9 presents the time/water volume (day/L) versus time. A good linear  
215 relationship is obtained, confirming that the water volume-time curve is of a  
216 hyperbolic shape. Thereby, the following equation can be adopted for this  
217 relationship:

$$218 \quad \frac{t}{V} = a + bt \quad \text{Eq.1}$$

219 where  $t$  is time,  $V$  is injected water volume,  $a$  and  $b$  are the intercept and the slope of  
220 the straight line, respectively (Figure 9).

221 According to this hyperbolic relationship, the maximum water volume corresponds to

222  $1/b$  (Eq.2), equal to 72.46 L. This is to be compared with the total volume of voids  
223 including the technological void and the soil porosity: 69.1 L.

$$224 \quad V_{max} = \lim_{t \rightarrow \infty} V(t) = \lim_{t \rightarrow \infty} \left( \frac{1}{a/t + b} \right) = \frac{1}{b} \quad \text{Eq.2}$$

225 During hydration, both the axial and radial swelling pressures were recorded by the  
226 total pressure sensors (see Figure 3) and the results are shown in Figure 10. The data  
227 by the sensor located at 1.20 m section for the axial swelling pressure measurement  
228 were unfortunately not available; only the axial swelling pressure values at 0 m  
229 section are presented. This pressure increased at an almost constant rate and reached  
230 1.63 MPa after 367 days. For the radial swelling pressure, the evolution rates were  
231 very different for the three sensors (see Figure 3); the pressure values reached were  
232 1.78 MPa, 0.56 MPa and 1.05 MPa for sensors L-01, L-02 and L-03, respectively.  
233 This indicates the heterogeneous radial swelling under the in-situ conditions.

### 234 **3.2 Small-scale test**

235 Figure 11 shows the measured water inflow over time. Once the water supply was  
236 connected to the bottom inlet, water volume increased rapidly and reached 49 mL in a  
237 few minutes. This value corresponded exactly to the volume of technological void  
238 (49 mL). Afterwards, water volume increased gradually to reach a maximum value of  
239 70.6 mL. No more water could infiltrate after about 200 days. The total volume of  
240 void (including the technological void  $V_{tech}$  and the void inside the soil  $V_{v-s}$ ) that  
241 could be filled with water was estimated at 69.1 mL. The result shows that a little  
242 more water was injected with respect to the estimated one (70.6 mL against 69.1 mL),

243 but the difference is quite small.

244 For further analyzing the evolution of water volume, the time/water volume (day/mL)  
245 is plotted versus time in Figure 12. As in the case of in-situ test, a straight line is  
246 obtained justifying a hyperbolic relationship between the water volume and the  
247 elapsed time (Eq.1). The value of  $1/b$  corresponds to the maximum volume of water:  
248  $1/b = 71.43$  mL, which is very close to the measured water volume (70.6 mL).

249 Figure 13 and Figure 14 depict the evolution of swelling pressure in the first stage (i.e.  
250 initial saturation phase). Once water was injected into the specimen, the axial swelling  
251 pressure increased very quickly (Figure 14). After about 2 days, the swelling pressure  
252 reached a first stability stage (1.30 MPa) and it restarted to increase on the 4<sup>th</sup> day.  
253 When the swelling pressure reached 1.45 MPa after about 12 days, a significant  
254 decrease of swelling pressure occurred and a minimum value of 0.70 MPa was  
255 reached. Afterwards, the swelling pressure increased again after about 33 days (Figure  
256 13), but at a slower rate. In addition, the evolution curve shows fluctuating pattern.  
257 The swelling pressure reached a mean value of 1.80 MPa after 300 days and then  
258 fluctuated in the range of 1.75-1.95 MPa.

259 The axial deformation during the swelling pressure development was also recorded,  
260 and shown in Figure 13. It followed the same trend as the swelling pressure. Note  
261 however that the variation of displacement was smaller than 0.2 mm. It represents  
262 0.16% of the specimen height (120 mm), suggesting a satisfactory control of axial  
263 displacement in this stage.

264 According to the data obtained in the first stage (Figure 13), no obvious swelling  
265 pressure increase occurred during a period of 50 days from day 300 to day 350. Thus,  
266 it was decided to start the second stage. For this purpose, the confining pressure was  
267 removed on day 350, allowing the free swell. Changes in axial swelling strain were  
268 recorded and presented in Figure 15. The uplifting of load cell led to an instantaneous  
269 rebound of 1.1% (1.4 mm / 120 mm). Afterwards, the axial swelling strain increased  
270 almost linearly at a rate of 0.145 mm/day. Following this rate, 20% of swelling strain  
271 was expected to be reached after 157 days. In order to reduce the test duration, two  
272 sides infiltration was applied on day 364. This resulted in an increase of the swelling  
273 strain rate to 0.588 mm/day, which is four times faster than that with one-side  
274 infiltration. The expected value of 20% (24 mm) was reached on day 400. The piston  
275 was then re-blocked automatically to start Stage 3. Note that the measured axial swell  
276 was 24.4 mm.

277 The evolution of swelling pressure was then measured again and the results are  
278 presented in Figure 16. Small fluctuation was observed and this fluctuation can be  
279 attributed to the daily temperature variations. As expected, the evolution curve follows  
280 a hyperbolic curve with a decreasing rate over time. It reached stabilization on day  
281 520 with a final swelling pressure of 0.18 MPa.

## 282 **4 COMPARISON AND DISCUSSION**

283 It was observed that more water infiltrated into the soil than that calculated by  
284 considering the technological void and the soil porosity in both the in situ test

285 (71.39 L) and laboratory small-scale test (70.60 mL). Even though the water volume  
286 has been not yet reached stabilization in the in-situ conditions, the discrepancy is  
287 found to be larger than in the small-scale test. This can be related to the natural  
288 conditions of the in-situ test, where some water intake by the host-rock did occur.  
289 With a well controlled condition in the small-scale test, the larger infiltrated water  
290 obtained may be related to the low water density ( $1.00 \text{ Mg/m}^3$ ) considered in the  
291 determination of soil void ratio. Indeed, for high plasticity materials as the MX80  
292 bentonite, the water density can be much higher than  $1.00 \text{ Mg/m}^3$  (Marcial 2003,  
293 Villar and Lloret 2004, Lloret and Villar 2007, Jacinto et al. 2012). This is in  
294 agreement with the observation from the KBS-3H mock-up test (Börgesson et al.  
295 2005).

296 Regarding the evolution of water volume, a hyperbolic relationship between the  
297 injected water volume and elapsed time was obtained in both tests. Accordingly, the  
298 maximum water volume was estimated at 72.46 L and 71.43 mL for the in-situ and  
299 small-scale tests, respectively. To compare the evolution curve at different scales, the  
300 water volume was normalized by using these two values. The normalized water  
301 volume is equal to the ratio of water volume at time  $t$  ( $V_t$ ) to the maximum water  
302 volume that can be injected (72.46 L and 71.43 mL for the in-situ and small-scale test,  
303 respectively). In terms of time scale, an up-scaling ratio of 2.5 (in situ test/small scale  
304 test) was found from the normalized water volume shown in Figure 17, where very  
305 similar evolution curves (normalized water volume versus normalized time) were  
306 obtained for the two tests (in situ and small scale tests).

307 This up-scaling ratio is much smaller than that estimated based on the consolidation  
308 theory by considering the experiment scale and hydration conditions: according to the  
309 infiltration length, the hydration rate of the in-situ test should be 100 times lower than  
310 in the small-scale test (1/10). As the two-side infiltration applied in the in-situ test  
311 increased the hydration rate by 4 times, the up-scaling ratio should be equal to 25  
312 (in-situ test / small scale test), still ten time larger than the rate identified from the  
313 measurements. In fact, under the field conditions, water may fill some voids between  
314 the pre-compacted disks during the first minutes (0.15 m thick, see Figure 2). This  
315 infiltration length of 0.15 m leads to an up-scaling ratio to 0.56. The up-scaling ratio  
316 of 2.5 observed is possibly related to the combined effect of these two phenomena.

317 Using this up-scaling ratio, the axial swelling pressure evolution curve obtained from  
318 the in-situ test (Figure 10) was normalized and presented in Figure 18, together with  
319 the axial swelling pressure measured in the first stage of the small-scale test. Except  
320 for the first 33 days (see Figure 13) where significant decrease of swelling pressure  
321 occurred in the small-scale test, the normalized curve of swelling pressure for the  
322 in-situ test join the curve of the small-scale test, confirming the up-scaling ratio of 2.5.

323 Based on the results of small-scale test, this ratio allows the time needed to reach the  
324 stabilization of swelling pressure in the in-situ test to be estimated. It can be observed  
325 in the small-scale test that the swelling pressure reached the stability after about 300  
326 days. Thus, 155 days more is needed to reach the maximum swelling pressure at the  
327 normalized time scale for the in-situ test. Accordingly, it can be estimated that the  
328 maximum swelling pressure in the in-situ test should be reached after 388 days,



329 corresponding to 754 days starting from the time of water injection.

330 As regards the kinetics of the axial swelling pressure in the first 33 days of small-scale  
331 test, stabilization was attained after about 2 days at 1.30 MPa and restarted to increase  
332 from day 4 (Figure 14). Wang et al. (2012b) observed similar phenomenon in swelling  
333 pressure tests on smaller samples (35 mm in diameter, 10 mm in height) with the same  
334 percentage of technological void. This is related to changes in microstructure of soil.  
335 With the progress of hydration, the effect of microstructure changes is reduced,  
336 resulting in the re-increase in swelling pressure (Cho et al., 2000; Baille et al., 2010).  
337 When the swelling pressure reached 1.45 MPa on day 12, a significant decrease of  
338 swelling pressure occurred, reaching a minimum value of 0.70 MPa. This decrease  
339 can be attributed to the filling of the technological void. Afterwards, the swelling  
340 pressure increased again from day 33. However, the evolution curve showed  
341 fluctuation due to the re-organization of soil microstructure under the effect of  
342 technological void.

343 On the contrary, the axial swelling pressure measured in the in-situ test increased  
344 constantly without any fluctuation. This can be related to a coupled effect of large  
345 scale and pressure sensor location. Indeed, in the small-scale test, the axial swelling  
346 pressure was measured on the whole cross section and any changes in axial pressure  
347 could be monitored. However, in the in situ test, the total pressure sensor was installed  
348 in the centre of the cross section (Figure 3) and the axial swelling pressure herein  
349 corresponded to the local one. Therefore, the axial swelling pressure changes occurred  
350 in the zone of technological void could not be detected by this sensor.

351 After the axial swelling pressure of small-scale test reached stabilization, removing  
352 the axial confining restriction led to a very small rebound of 1.1% (1.4 mm/ 120 mm).  
353 This observation provides valuable information for the confinement removal phase of  
354 the in-situ test. During the free swelling process (Stage 2), a swelling strain evolution  
355 rate (swelling strain/time) of 0.588 mm/day was observed under two-side infiltration  
356 conditions. Combined with the up-scaling ratio, this result (0.588 mm/day) allows  
357 prediction of the swelling strain evolution in the in-situ test when simulating an  
358 incidental decrease of the swelling pressure caused by a failure of the concrete  
359 confining structure.

360 As the piston was re-blocked automatically in the small-scale test (Stage 3), swelling  
361 pressure developed again. This indicates the favorable sealing capacity after filling of  
362 the technological void. If a saturation defect or a confining structure failure occurs in  
363 the field, a 20% additional void could be sealed. A final swelling pressure of  
364 0.18 MPa was attained, which is in accordance with the swelling pressures measured  
365 in the laboratory on smaller samples (Wang et al., 2012b): after the 20% free swell  
366 (24.5 mm), the dry density decreased to a final value of  $1.39 \text{ Mg/m}^3$ ; this corresponds  
367 to a swelling pressure of 0.23 MPa.

## 368 **5 CONCLUSION**

369 In the context of SEALEX project, a laboratory small-scale test (1/10) was carried out  
370 to investigate the recovery capacity of bentonite-based plug with technological void.  
371 By comparison with the first results from the in-situ test PT-N1, the phenomena

372 identified in the laboratory were used for interpreting and estimating the results from  
373 the in-situ test.

374 During the saturation process, a hyperbolic relationship between the injected water  
375 volume and elapsed time was obtained in both laboratory and field tests. However, a  
376 little more water was injected as compared to the water volume estimated by  
377 considering the total porosity. Larger discrepancy was found for the in-situ test due to  
378 the effect of natural conditions.

379 Decrease of axial swelling pressure was observed in the small-scale test due to the  
380 filling of technological void. In contrast, the axial swelling pressure measured  
381 increased continually in the in-situ test. This could be attributed to the effects of both  
382 the scale and the locations of pressure sensors.

383 Comparison of the injected water volume and the axial swelling pressure between the  
384 two different scales gave the same up-scaling ratio of 2.5 (in-situ scale / laboratory  
385 scale). Using this up-scaling ratio, the time needed to reach the swelling pressure  
386 stabilization in the in-situ test was estimated at 754 days.

387 After removal of the axial confining restriction, a swelling strain evolution rate  
388 (swelling strain/time) of 0.588 mm/day was observed in the case of two-side  
389 infiltration. Combined with the up-scaling ratio, this rate allowed prediction of the  
390 swelling strain evolution in case of a confining structure failure. A swelling pressure  
391 of 0.18 MPa was obtained after filling an additional void of 20%, indicating the  
392 favorable sealing capacity after filling the technological void.

393 **ACKNOWLEDGEMENTS**

394 The work was conducted in the framework of the SEALEX project carried out by  
395 IRSN, with collaboration of the Canadian Nuclear Safety Commission. The supports  
396 from the China Scholarship Council (CSC) and from the PHC Cai Yuanpei project  
397 (24077QE) are also greatly acknowledged.

398 **REFERENCES**

- 399 Baille, W., Tripathy, S. & Schanz, T. 2010. Swelling pressures and one-dimensional  
400 compressibility behaviour of bentonite at large pressures. *Applied Clay Science*, Vol 48,  
401 324-333
- 402 Barnichon, J.D. & Deleruyelle, F. 2009. Sealing Experiments at the Tournemire URL.  
403 EUROSAFE.
- 404 Barnichon, J.D., Dick, P. & Bauer, C. 2012. The SEALEX in situ experiments: performance  
405 test of repository seals. *Harmonising Rock Engineering and the Environment – Qian &*  
406 *Zhou (eds) Taylor & Francis Group, London. ISBN 978-0-415-80444-8, pages*  
407 *1391-1394.*
- 408 Börgesson, L., Sandén, T., Fälth, B., Åkesson, M. & Lindgren, E. 2005. Studies of Buffers  
409 Behaviour in KBS-3H Concept: Work During 2002-2004, SKB, R-05-50.
- 410 Cho, W.J., Lee, J.O., & Kang, C.H. 2000. Influence of temperature elevation on the sealing  
411 performance of a potential buffer material for a high-level radioactive waste repository.  
412 *Annals of Nuclear Energy*, Vol 27, 1271-1284
- 413 Delage, P., Howat, M.D. & Cui., Y.J. 1998. The relationship between suction and swelling  
414 properties in a heavily compacted unsaturated clay. *Engineering Geology*, 50(1-2),  
415 31-48.
- 416 Jacinto, A.C., Villar, M.V. & Ledesma, A. 2012. Influence of water density on the  
417 water-retention curve of expansive clays, *Ge´otechnique* 62, No. 8, 657–667
- 418 Lloret, A., Villar, M.V., Sánchez, M., Gens, A., Pintado, X. & Alonso, E.E. 2003. Mechanical  
419 behaviour of heavily compacted bentonite under high suction changes. *Ge´otechnique* 53,  
420 No. 1, 27–40
- 421 Lloret, A. & Villar, M. 2007. Advances on the knowledge of the thermo-hydro-mechanical  
422 behaviour of heavily compacted FEBEX bentonite. *Physics and Chemistry of the Earth*,  
423 32, 701-715
- 424 Marcial, D. 2003. Comportement hydromécanique et microstructural des matériaux de  
425 barrière ouvragée, PHD thesis, École Nationale des Ponts et Chaussées, Paris, France.
- 426 Romero, E., Villar, M. V. & Lloret, A. 2005. Thermo-hydro-mechanical behaviour of heavily  
427 overconsolidated clays. *Engng Geol.* 81(3): 255 – 268.
- 428 Villar, M.V. & Lloret, A. 2004. Influence of temperature on the hydro-mechanical behaviour  
429 of a compacted bentonite. *Applied Clay Science*, 26(1-4), 337-350.
- 430 Wang, Q., Tang, A. M., Cui, Y.J., Delage, P. & Gatzmiri, B. 2012a. Experimental study on the

431 swelling behaviour of bentonite/claystone mixture, *Engineering Geology*, Vol. 124,  
432 59–66.  
433 Wang, Q., Tang, A. M., Cui, Y.J., Delage, P., Barnichon, J.D. & Ye, W.M. 2012b. The effects  
434 of technological voids on the hydro-mechanical behaviour of compacted bentonite-sand  
435 mixture. *Soils and Foundations*, Vol. 53(2), 232-245..  
436

437 **List of Tables**

438

439 Table 1. Chemical composition of the synthetic water.

440 **List of Figures**

441

442 Figure 1. Layout of the SEALEX in-situ experiment (after Barnichon and Deleruyelle, 2009)

443 Figure 2. Geometry of the clay plug and the compacted bricks

444 Figure 3. Distribution and installation of the total pressure sensors

445 Figure 4. Experimental devices

446 Figure 5. Sample preparation

447 Figure 6. A schematic description of the three stages of the small scale test

448 Figure 7. Lifting of load cell for free swell

449 Figure 8. Injected water volume versus time

450 Figure 9. Time/water volume versus elapsed time after water rejection

451 Figure 10. Evolution of swelling pressure

452 Figure 11. Water volume injected into the specimen

453 Figure 12. Time/water volume versus elapsed time

454 Figure 13. Evolution of axial swelling pressure and displacement in the first stage

455 Figure 14. Evolution of swelling pressure during the first 33 days

456 Figure 15. Evolution of axial swelling strain during Stage 2

457 Figure 16. Evolution of axial swelling pressure during Stage 3

458 Figure 17. Normalized water volume versus normalized time

459 Figure 18. Swelling pressure versus normalized time

460

461

462 Table 1. Chemical composition of the synthetic water.

Compound	NaHCO <sub>3</sub>	Na <sub>2</sub> SO <sub>4</sub>	NaCl	KCl	CaCl <sub>2</sub> .2H <sub>2</sub> O	MgCl <sub>2</sub> .6H <sub>2</sub> O	SrCl <sub>2</sub> .6H <sub>2</sub> O
Mass (g) per Litter of solution	0.28	2.216	0.615	0.075	1.082	1.356	0.053

463

464

465

466

467

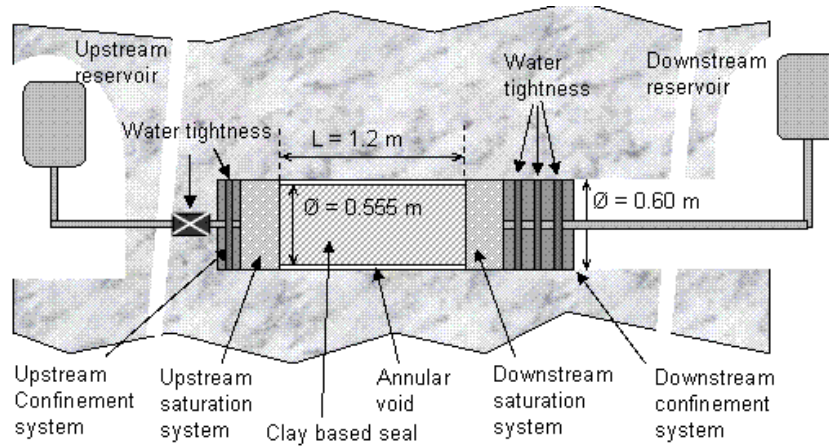

468

469

470 Figure 1. Layout of the SEALEX in-situ experiment (after Barnichon and Deleruyelle, 2009).

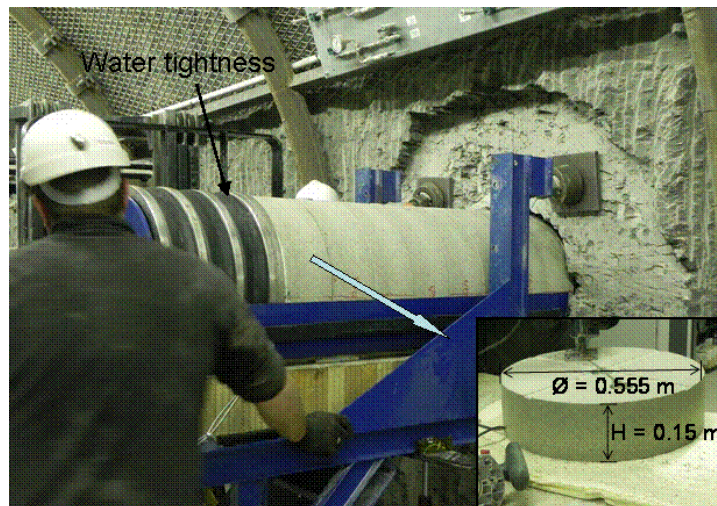

471

472

Figure 2. Geometry of the clay plug and the pre-compacted blocks.

473

474



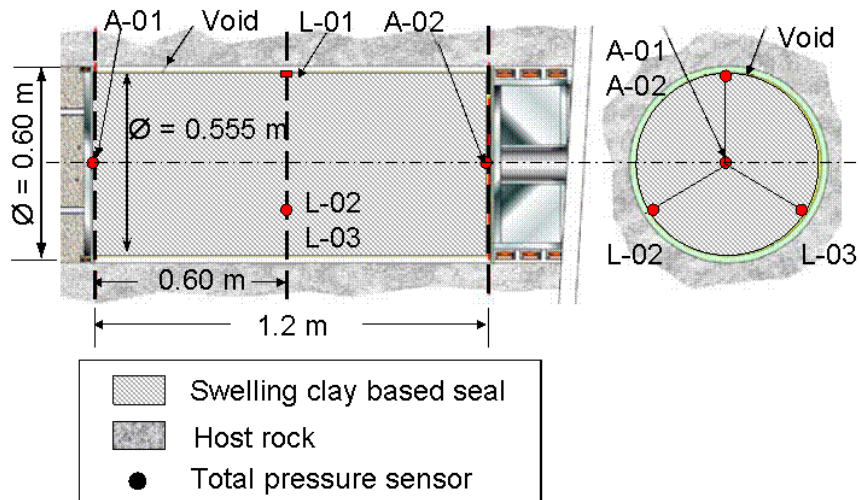

475

476

(a) Distribution of the total pressure sensors

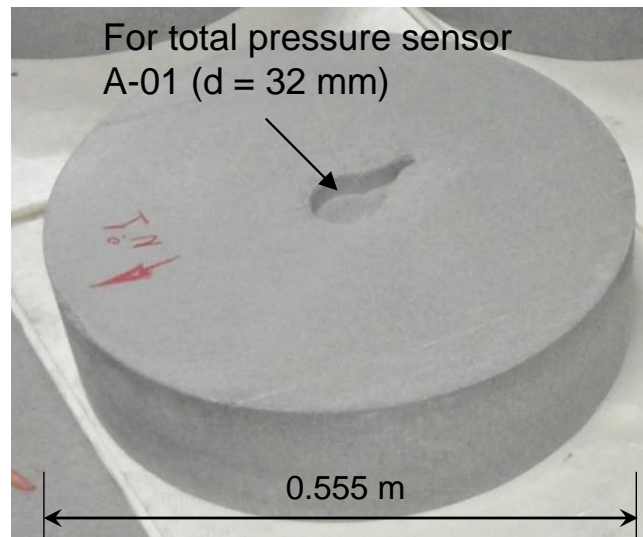

477

478

(b) Hole machined for installation of wireless sensor

479

Figure 3. Distribution and installation of the total pressure sensors.

480

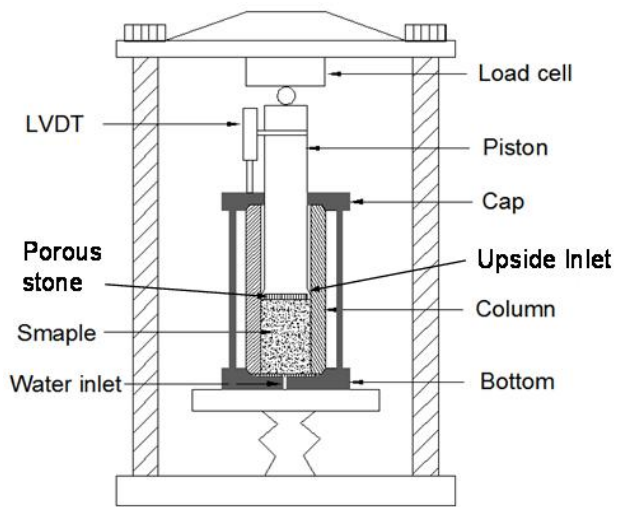

481

482

Figure 4. Experimental devices.

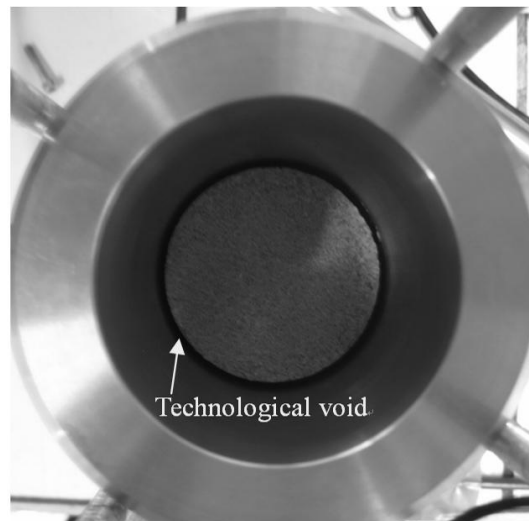
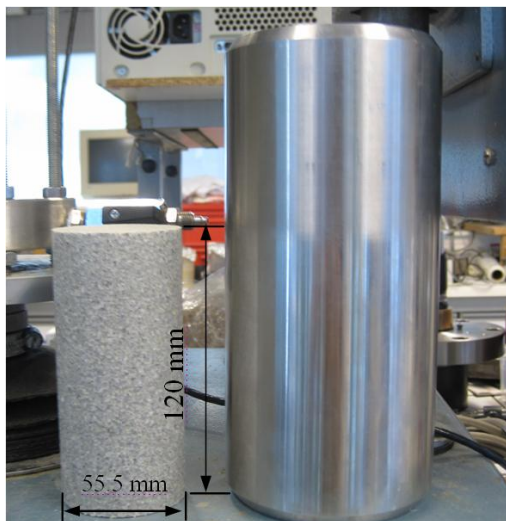

483

484

(a)

(b)

Figure 5. Sample preparation.

485

486

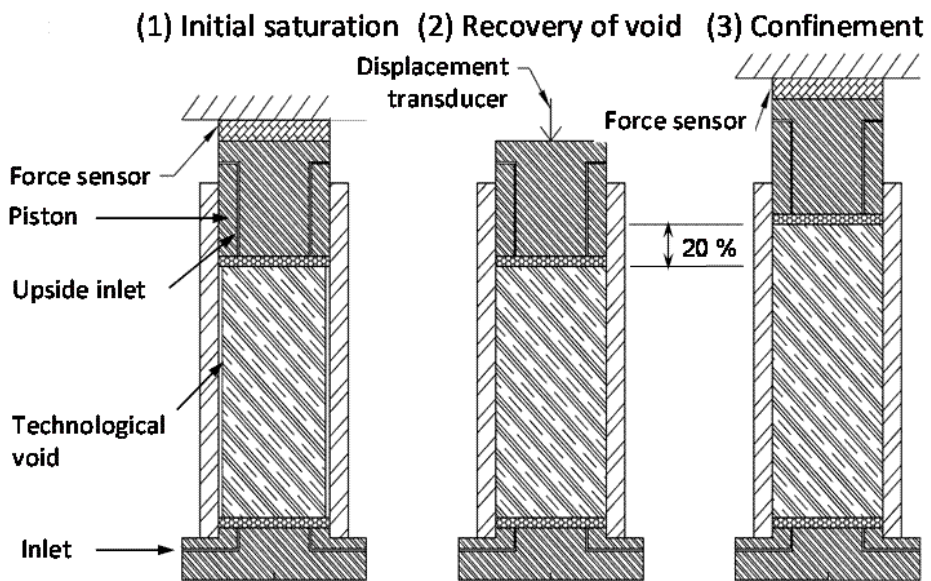

487

488

Figure 6. A schematic description of the three stages of the small-scale test.

489

490

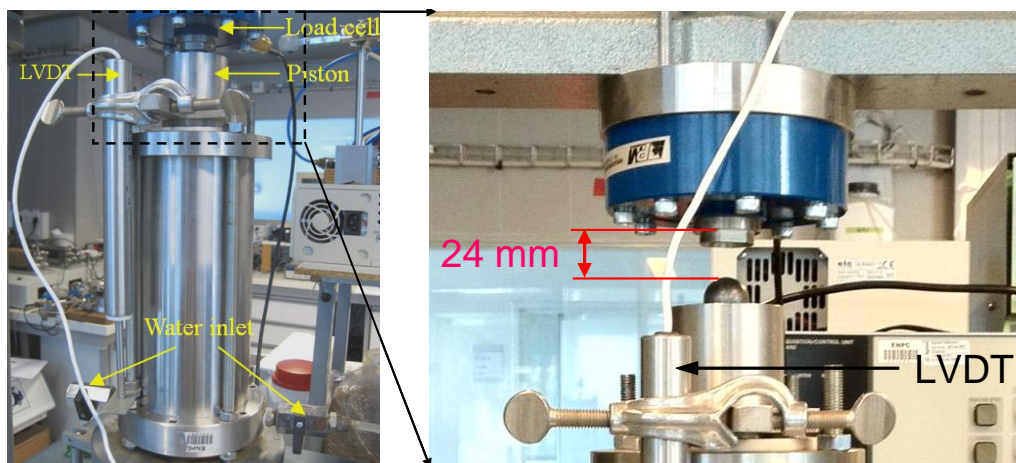

491

Figure 7. Lifting of load cell for free swell.

492

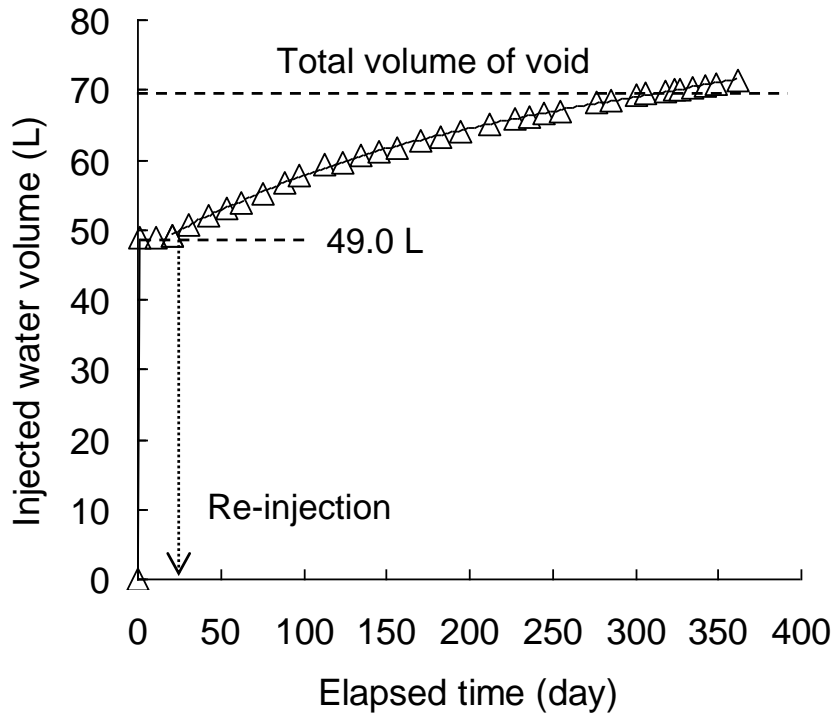

493

494

Figure 8. Injected water volume versus time.

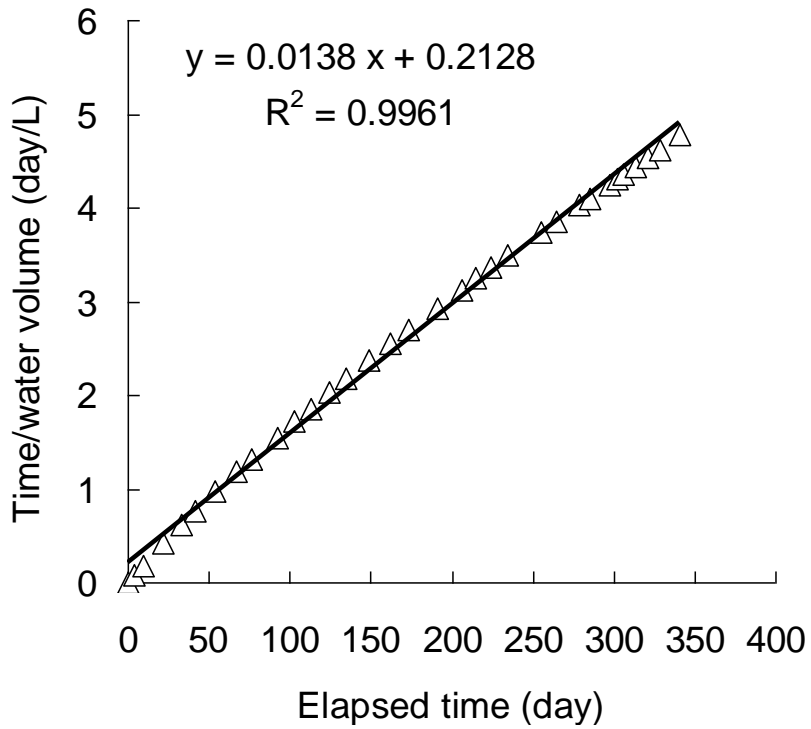

495

496

Figure 9. Time/water volume versus elapsed time after water rejection.

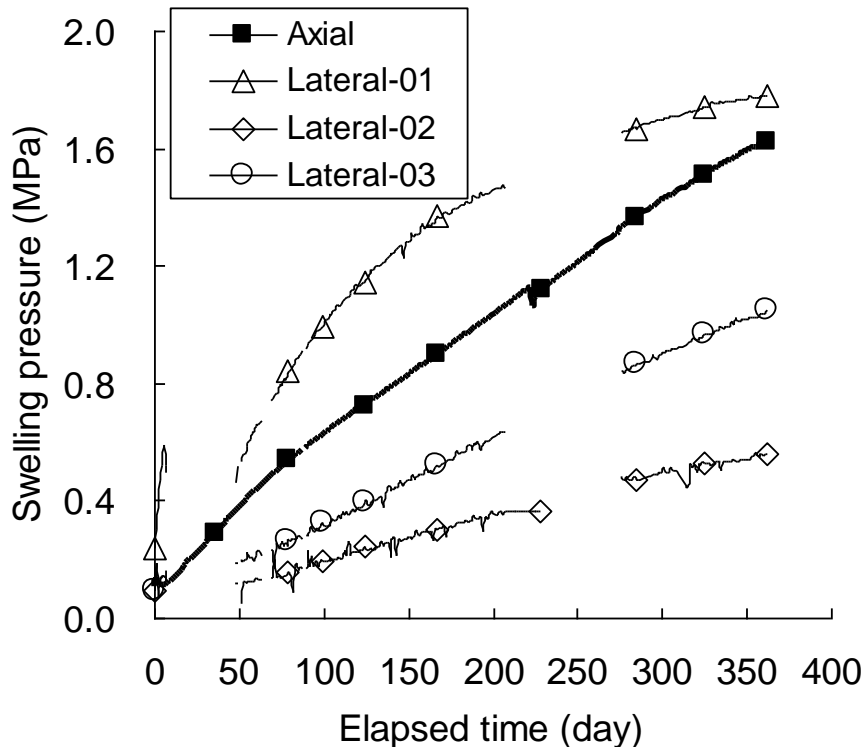

497

498

Figure 10. Evolution of swelling pressure.

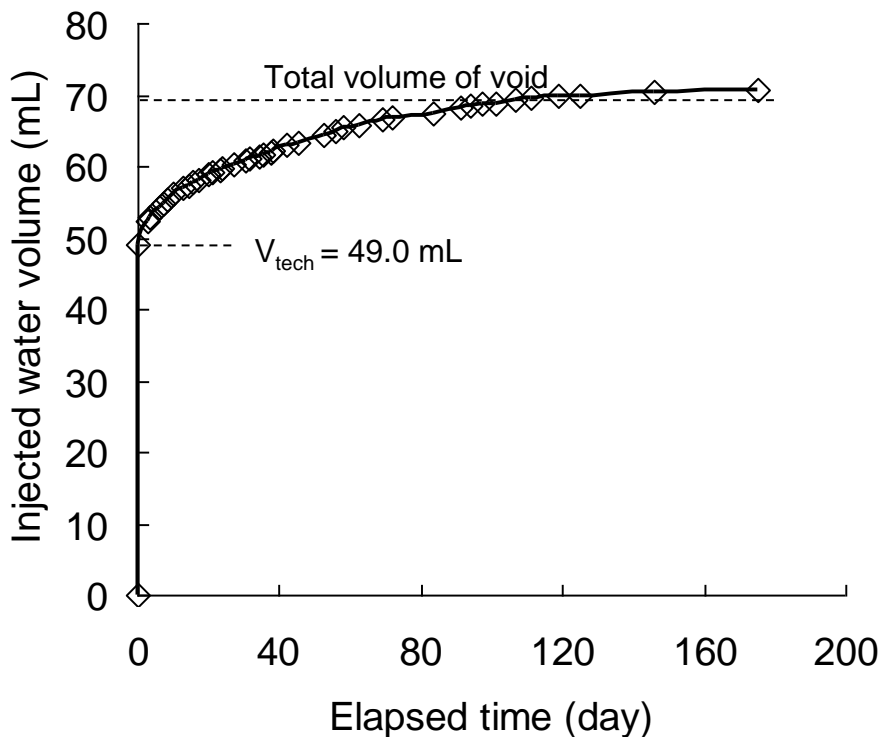

499

500

Figure 11. Water volume injected into the specimen.

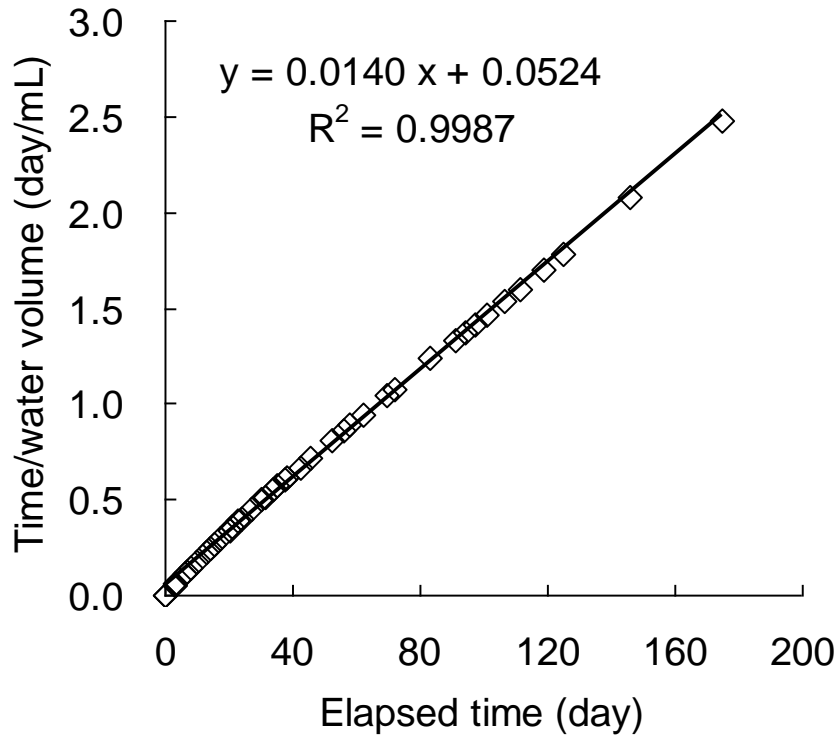

501

502

Figure 12. Time/water volume versus elapsed time.

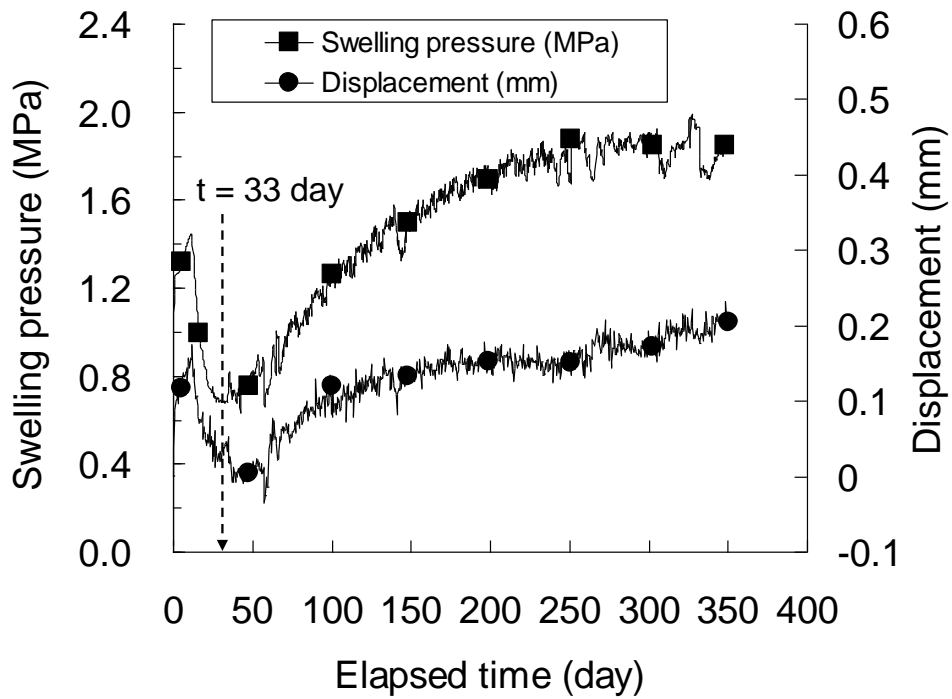

503

504

Figure 13. Evolution of axial swelling pressure and displacement in the first stage.

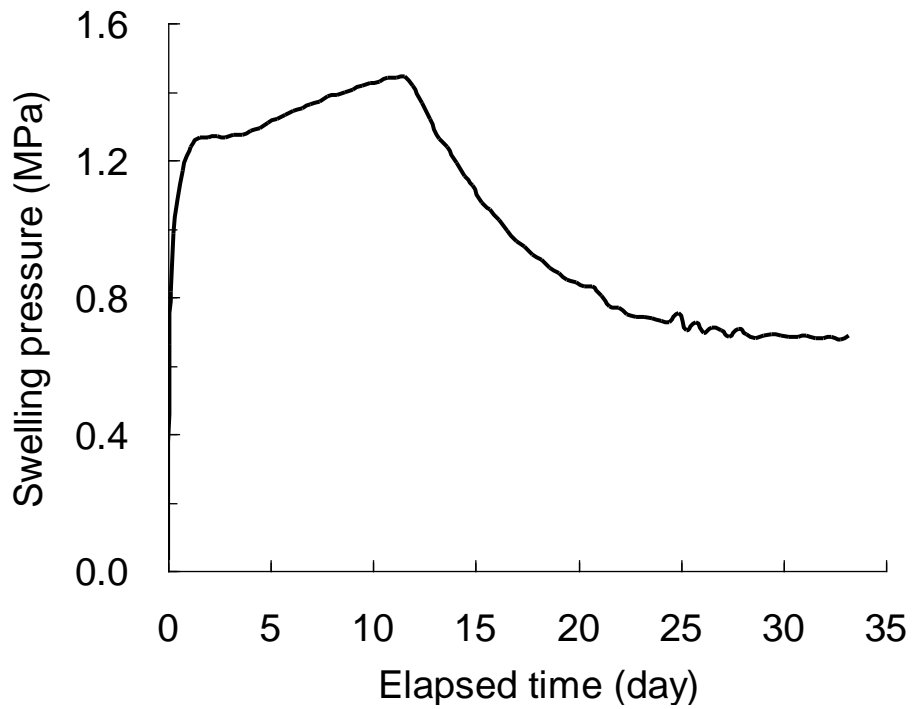

505

506

Figure 14. Evolution of swelling pressure during the first 33 days.

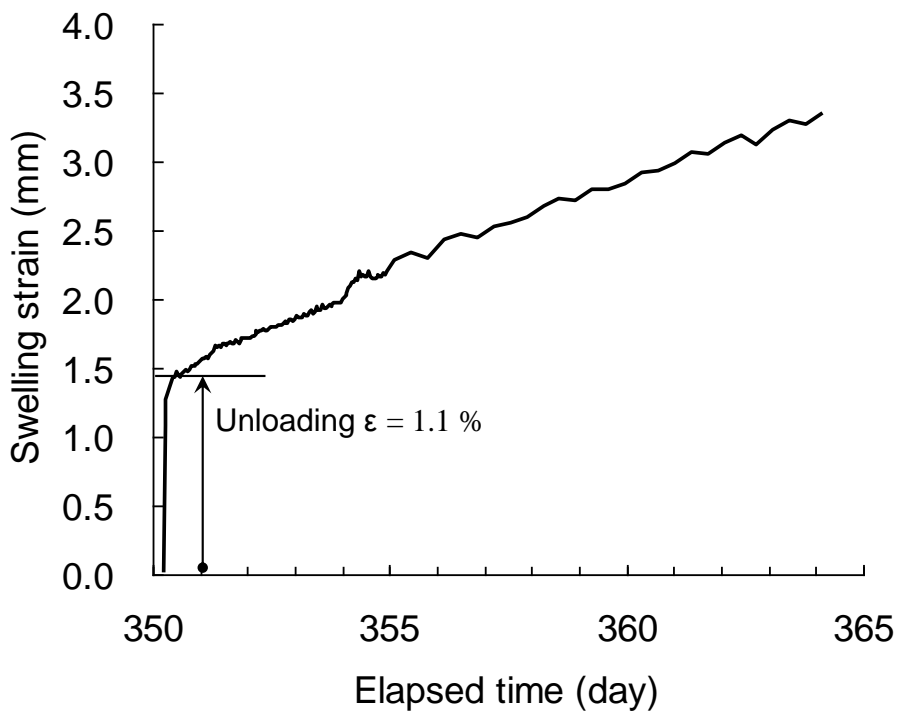

507

508

(a) Evolution of axial swelling strain during the first 15 days after unloading.

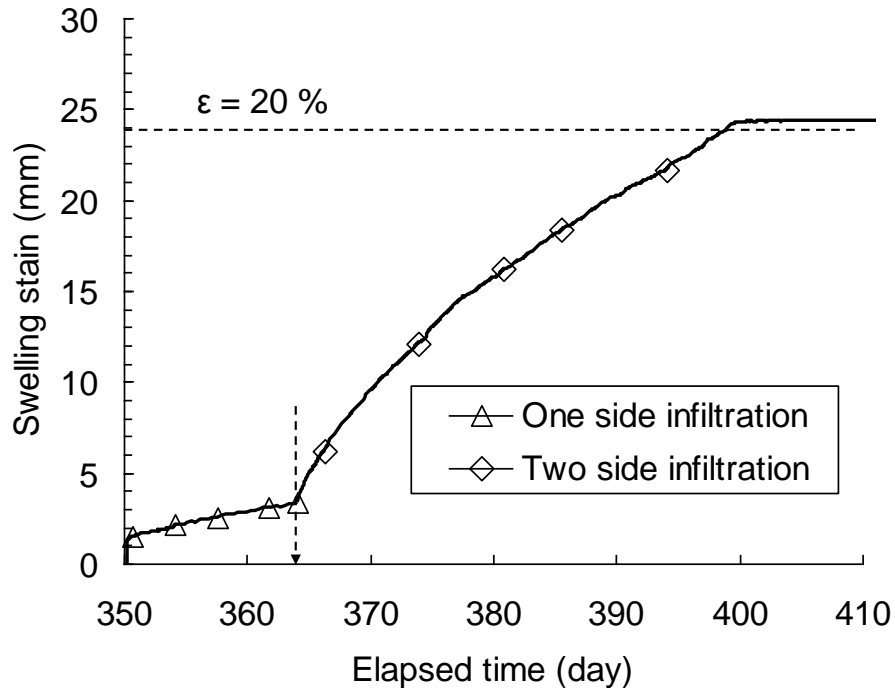

509

510

(b) Evolution of axial swelling strain

511

Figure 15. Evolution of axial swelling strain during Stage 2.

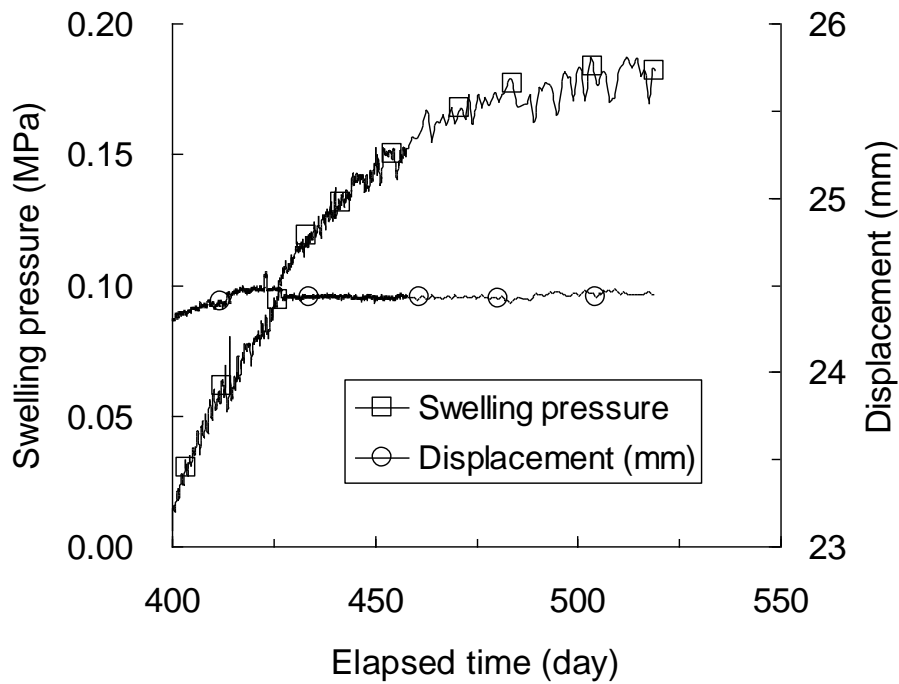

512

513

Figure 16. Evolution of axial swelling pressure during Stage 3.



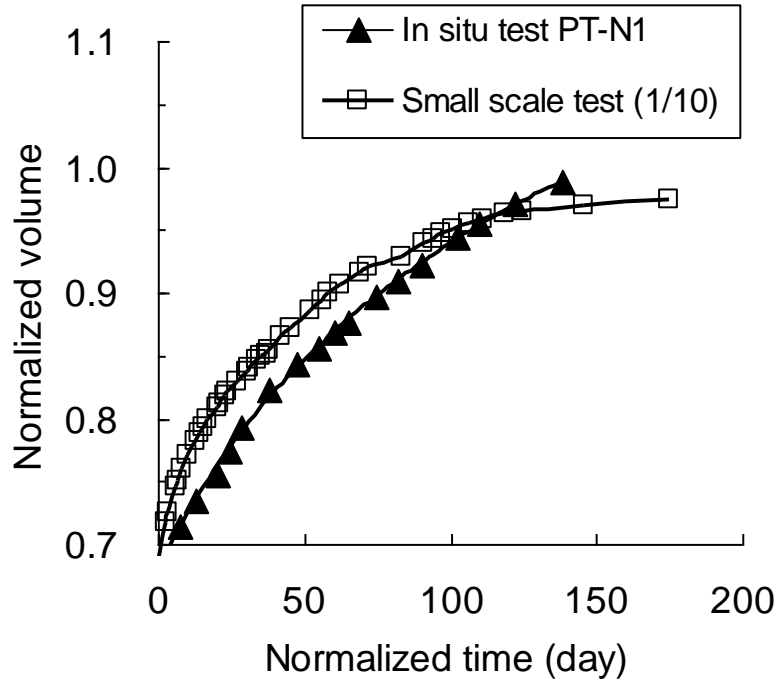

514

515

Figure 17. Normalized water volume versus normalized time.

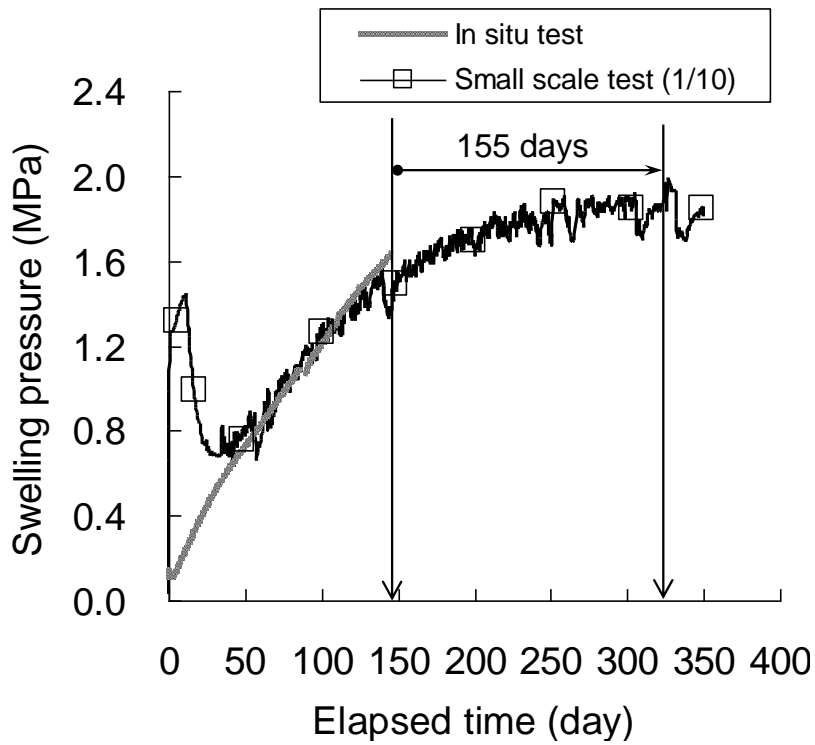

516

517

518

Figure 18. Swelling pressure versus normalized time.