



**HAL**  
open science

## An Experimental Study on the Secondary Deformation of Boom Clay

Yongfeng Deng, Yu-Jun Cui, Anh Minh A.M. Tang, Xiang-Ling Li, Xavier  
Sillen

► **To cite this version:**

Yongfeng Deng, Yu-Jun Cui, Anh Minh A.M. Tang, Xiang-Ling Li, Xavier Sillen. An Experimental Study on the Secondary Deformation of Boom Clay. *Applied Clay Science*, 2012, 59-60, pp.19-25. 10.1016/j.clay.2012.02.001 . hal-00693412

**HAL Id: hal-00693412**

**<https://enpc.hal.science/hal-00693412v1>**

Submitted on 2 May 2012

**HAL** is a multi-disciplinary open access archive for the deposit and dissemination of scientific research documents, whether they are published or not. The documents may come from teaching and research institutions in France or abroad, or from public or private research centers.

L'archive ouverte pluridisciplinaire **HAL**, est destinée au dépôt et à la diffusion de documents scientifiques de niveau recherche, publiés ou non, émanant des établissements d'enseignement et de recherche français ou étrangers, des laboratoires publics ou privés.

1                   **An Experimental Study on the Secondary Deformation of Boom Clay**

2  
3                   **Y.F. Deng<sup>1,2</sup>, Y.J. Cui<sup>2</sup>, A.M. Tang<sup>2</sup>, X.L. Li<sup>3</sup>, X. Sillen<sup>4</sup>**

- 4  
5 1. Southeast University, Institute of Geotechnical Engineering, Transportation College,  
6     Nanjing, China ( noden@163.com )  
7 2. Ecole des Ponts ParisTech, Navier/CERMES, Marne-la-Vallée, France  
8     (yujun.cui@enpc.fr )  
9 3. Euridice Group, c/o SCK/CEN, Mol, Belgium (xli@sckcen.be )  
10 4. ONDRAF/NIRAS, Belgium (xavier.sillen@sckcen.be )

11  
12  
13  
14  
15  
16  
17     **Corresponding author**

18     Prof. Yu-Jun Cui  
19     Ecole des Ponts ParisTech, UMR Navier/CERMES  
20     6-8 av. Blaise Pascal, Cité Descartes, Champs-sur-Marne  
21     F-77455 MARNE-LA-VALLEE CEDEX 2  
22     France  
23  
24     E-mail: yujun.cui@enpc.fr  
25     Tel: +33 1 64 15 35 50  
26     Fax: +33 1 64 15 35 62

27 **Abstract**

28 Boom clay formation, a deposit of slightly over-consolidated marine clay that belongs to the  
29 Oligocene series in the north east of Belgium, has been selected as a possible host material of  
30 nuclear waste disposal. In this context, the long-term deformation behaviour of Boom clay is  
31 of crucial importance in the performance assessment of the whole storage system. In this  
32 study, low and high pressure oedometer tests are carried out; the e-log  $\sigma'_v$  (void ratio –  
33 logarithm of vertical effective stress) and e-log  $t$  (void ratio – logarithm of time) curves  
34 obtained are used to determine the compression index  $C_c^*$ , swelling index  $C_s^*$  and secondary  
35 deformation coefficient  $C_\alpha$  during both loading and unloading. The relationship between  $C_\alpha$   
36 and the effective stress ratio ( $\sigma'_v/\sigma'_c$ , vertical effective stress to pre-consolidation stress) is  
37 analysed, and it is observed that  $C_\alpha$  increases linearly with  $\log \sigma'_v/\sigma'_c$ . Examination of the  
38 ratio of  $C_\alpha/C_c^*$  for various soils shows that the secondary deformation behaviour of Boom  
39 clay is similar to that of shale and mudstone. The relation between  $C_\alpha$  and  $C_c^*$  is linear; but  
40 the relation between  $C_\alpha$  and  $C_s^*$  is bi-linear. The bi-linearity observed is related to two  
41 different mechanisms: the mechanically dominated rebounding and the physico-chemically  
42 dominated swelling.

43

44 **Keywords:** Boom clay; oedometer test; secondary deformation behavior; mechanically  
45 dominated rebounding; physico-chemically dominated swelling.

## 46 1. Introduction

47 Boom clay formation, a thick deposit of slightly over-consolidated marine clay has been  
48 selected as a possible host material of nuclear waste disposal in Belgium. In this context, its  
49 volume change behaviour, especially its secondary deformation behaviour is essential for the  
50 safety of the whole storage system, and therefore needs to be investigated in depth.

51 The consolidation of fine-grained soils has been commonly described by the primary  
52 consolidation and the secondary consolidation. The former refers to the soil volume change  
53 due to water pressure dissipation whereas the latter refers to the soil volume change due to the  
54 evolution of soil fabric and soil-water interaction. In the past decades, many studies were  
55 conducted to correlate the secondary deformation coefficient ( $C_\alpha$ ) during loading with other  
56 soil characteristics. Walker (1969) showed that  $C_\alpha$  varied with the ratio of vertical effective  
57 stress ( $\sigma'_v$ ) to the pre-consolidation pressure ( $\sigma'_c$ ), with the largest  $C_\alpha$  at a stress slightly  
58 higher than  $\sigma'_c$ . This was confirmed by other studies on various soils (Brook and Mark, 2000;  
59 Yilmaz and Saglamer, 2004; You, 1999; Zhu *et al.*, 2005; Shirako *et al.*, 2006; Suneel *et al.*,  
60 2008; Costa and Ioannis, 2009). Walker and Raymond (1968) found that the secondary  
61 deformation coefficient ( $C_\alpha$ ) during loading has a linear relationship with the compression  
62 index ( $C_c$ ) over the full range of stress applied. This  $C_\alpha$ - $C_c$  relation was further investigated by  
63 many other researchers (Mesri and Castro, 1987; Mesri *et al.*, 1997; Abdullah *et al.*, 1997;  
64 Al-Shamrani, 1998; Brook and Mark, 2000; You, 1999; Feng *et al.*, 2001; Tan, 2002; Mesri,  
65 2004; Zhang *et al.*, 2005; Zhu *et al.*, 2005; Costa and Ioannis, 2009; Feng and Zhu, 2009;  
66 Mesri and Vardhanabhuti, 2009) on various soils (intact clays, remoulded clays, clays treated  
67 with lime or cement, and sands); the results confirmed the observation by Walker and  
68 Raymond (1968). Mesri *et al.* (1994) defined four groups of soils according to the value of the  
69 ratio  $C_\alpha/C_c$  (Table 1). Some other correlations were also attempted between  $C_\alpha/C_c$  (or  $C_\alpha$ ) and  
70 soil physical properties such as the liquid limit  $w_L$ , plastic limit  $w_P$  and plasticity index  $I_p$   
71 (You, 1999; Suneel *et al.*, 2008).

72 Although the secondary consolidation behaviour of soils has been widely investigated,  
73 there have been few studies on the stiff Boom clay, especially on the unloading path that  
74 represents the situation of the soil in vicinity of excavated galleries. In the present work,  
75 consolidation tests are performed in both low and high pressure oedometers on Boom clay  
76 taken from the sites of Essen and Mol, Belgium. Loading and unloading are run in steps and  
77 the secondary deformation coefficient  $C_\alpha$  is determined for each step. Furthermore, the  
78 relations between  $C_\alpha$ , the effective stress ratio ( $\sigma'_v/\sigma'_c$ ), compression and swelling indexes  
79 ( $C_c^*$  and  $C_s^*$ ) are analyzed. The main objective is to study the variations of  $C_\alpha$  during  
80 unloading and the mechanisms involved in these variations. Note that the use of high pressure  
81 oedometer in this study allows studying the variation of  $C_\alpha$  at large stress ratio  $\sigma'_v/\sigma'_c$ ,  
82 indispensable for deeply located soil as Boom clay (223 m deep in Mol and about 240 m in  
83 Essen). Moreover, the introduction of parameter  $C_c^*$  and  $C_s^*$  allows analysing the soil  
84 compression behaviour with a non-linear loading-unloading curve. Note also that, to the  
85 authors' knowledge, there have been no studies before focusing on the variations of  $C_\alpha$  during  
86 unloading.

## 87 2. Soil studied

88 The soil studied was taken by coring at the sites of Essen and Mol, Belgium. The location of  
89 the two sites is shown in Figure 1 (De Craen *et al.*, 2006). The Essen site is situated in the  
90 north east of Belgium, about 60 km far from the underground research laboratory (URL) at  
91 the Mol site. After being taken from the borehole, the cores were sealed in plastic tubes  
92 having ends closed and transported to the laboratory. Five soil cores of 1-m length and  
93 100-mm in diameter from Essen and one soil core of 0.5-m length and 100-mm in diameter  
94 from Mol were studied. The details of these cores are shown in Table 2, with the  
95 corresponding depth, member, unit mass of solids ( $\rho_s$ ), liquid limit ( $w_L$ ), plastic limit ( $w_P$ ),  
96 plasticity index ( $I_p$ ), water content ( $w_0$ ) and void ratio ( $e_0$ ). There are three cores taken from  
97 the Putte member (Mol, Ess75 and Ess83) and three cores from the Terhagen members (Ess96,  
98 Ess104 and Ess112). The geotechnical identification parameters of the cores from Essen are  
99 similar:  $\rho_s = 2.64 - 2.68$ ;  $w_L = 62 - 78\%$ ;  $w_P = 25 - 33\%$ ;  $I_p = 36 - 45$ . The values are also  
100 close for both water content and void ratio:  $w_0 = 27.2 - 29.7$ ,  $e_0 = 0.700 - 0.785$ . For the core  
101 from Mol, the values of  $\rho_s$ ,  $w_L$ ,  $w_P$  and  $I_p$  are similar to that of the cores from Essen, but the  
102 water content and void ratio are lower than the cores from Essen, showing that Boom clay  
103 from Mol is denser.

## 104 3. Experimental techniques

105 Both low pressure (0.05 - 3.2 MPa) and high pressure (0.125 - 32MPa) oedometer tests were  
106 carried out following the French standards (AFNOR 1995, 2005) on the six Boom clay cores.  
107 The tests in low pressure oedometer aim at studying the loading-unloading behavior of the  
108 soil near the excavation gallery, whereas the tests in high pressure oedometer aim at studying  
109 the compression behavior in large stress level (far from the excavation gallery). The soil  
110 samples were prepared by trimming and had 50-mm in diameter and 20-mm in height. In the  
111 following, high pressure oedometer test is named Oedo1 while low pressure test is named  
112 Oedo2. Note that the high pressure oedometer has the same principle as the standard low  
113 pressure oedometer; the main difference is that in high pressure oedometer two amplification  
114 levels were used with a ratio of 1:10 for the first level and 1:5 for the second level (see Figure  
115 2). In other words, the frame of high pressure oedometer allows multiplying the applied  
116 weight by 50, which leads to a maximum force of 12 tons. In the experiments, the minimum  
117 and maximum applied weights are 5 N and 1280 N, leading to a minimum and maximum  
118 vertical pressure of 0.125 MPa and 32 MPa respectively for a sample of 50 mm diameter.

119 The soil specimen was installed in the cell with dry porous stones. Prior to circulation of  
120 the synthetic water which has the same chemistry as the in-situ pore water (Cui *et al.*, 2009)  
121 in the drainage system, a confining pressure equal to the estimated in situ stress was applied.  
122 This prevents the soil swelling during re-saturation which may modify the soil microstructure  
123 and as a result the soil mechanical properties (Delage *et al.*, 2007).

124 The in situ stress of the soil was estimated using Eq. 1:

$$125 \sigma'_{v0} = \gamma h - u_0 \quad (1)$$

126 where  $\sigma'_{v0}$  is the in situ effective vertical stress;  $\gamma$  is the mean unit weight of the soil above the  
127 depth considered, taken equal to 20 kN/m<sup>3</sup> following the data of De Craen *et al.* (2006);  $h$  is

128 the depth of the soil core (see Table 2);  $u_0$  is the in situ pore pressure estimated from the  
129 ground water level that is assumed to be at the ground surface. The  $\sigma'_{v0}$  values determined  
130 for Ess75, Ess83, Ess96, Ess104, Ess112 and Mol are 2.20, 2.27, 2.40, 2.48, 2.56 and  
131 2.23 MPa, respectively. For a reason of convenience,  $\sigma'_{v0}$  in both low pressure and high  
132 pressure oedometers was set at 2.40 MPa for all tests.

## 133 4. Experimental results

### 134 4.1. Compressibility behavior

135 Figure 3 presents the loading-unloading-reloading stages and the corresponding changes in  
136 vertical displacement in test Ess75Oedo1. Before the re-saturation phase, a loading from  
137 0.125 to 2.4 MPa was applied to reach the in situ stress state. The soil sample was then  
138 re-saturated using synthetic water. The subsequent unloading-reloading stages were as follows:  
139 unloading from point A (2.4 MPa) to B (0.125 MPa); loading to C (16 MPa); unloading to D  
140 (0.125 MPa); loading to E (32 MPa) and unloading to F (0.125 MPa). Common results were  
141 obtained in terms of vertical displacements, *i.e.* compression upon loading and rebounding  
142 upon unloading. Note that the French standards – AFNOR (1995, 2005) were applied as  
143 regards the deformation stabilization for all odometer tests: stabilization is achieved when the  
144 displacement rate is lower than 0.01mm/h.

145 Figure 4 presents the compression curve (void ratio versus  $\log \sigma'_v$ ) of test Ess75Oedo1,  
146 together with the compression curve of test Ess75Oedo2 in low pressure odometer. In test  
147 Ess75Oedo2, after the re-saturation using synthetic water under 2.4 MPa stress, unloading  
148 was performed from point I (2.4 MPa) to point II (0.05 MPa), then loading to point III  
149 (3.2 MPa) and finally unloading to point IV (0.05 MPa).

150 The low pressure odometer test Ess75Oedo2 shows a quasi elastic behavior with narrow  
151 unloading-loading loops. A deeper examination shows, however, that the reloading curve from  
152 II to III is not linear in the plane  $e$ - $\log \sigma'_v$ . This non-linearity can be also observed on the  
153 curve of test Ess75Oedo1 on the reloading paths from B to C and from D to E. Note that the  
154 results from the tests on other cores are similar to that shown in Figure 4. Obviously, it is  
155 difficult to determine the pre-yield stress  $\sigma'_y$  using the Casagrande method on these curves. In  
156 addition, this pre-yield stress, if any, does not correspond to the pre-consolidation pressure  $\sigma'_c$   
157 ( $\sigma'_y$  is much lower than  $\sigma'_c$ ):  $\sigma'_c$  is equal to 2.4 MPa at point A, but when reloading from B to  
158 C,  $\sigma'_y$  seems to be much lower, about 1 MPa. For this reason, in the following analysis only  
159  $\sigma'_c$  is used and its determination is based on the stress history:  $\sigma'_c$  is the maximum stress  
160 applied in the odometer tests. For instance,  $\sigma'_c = 16$  MPa for the paths C->D and D->E;  $\sigma'_c$   
161 = 32 MPa for the path E->F;  $\sigma'_c = 3.2$  MPa for the path III->IV is 3.2 MPa.

162 Since the  $e$ - $\log \sigma'_v$  curves of Boom clay are not linear during unloading and unloading,  
163 especially for the low pressure odometer tests, it is difficult to use an unique compression  
164 index ( $C_c$ ) and swell index ( $C_s$ ) to describe the compression and swelling behavior. Hence the  
165 above two indexes are determined stage by stage, and renamed  $C_c^*$  and  $C_s^*$ , respectively. It  
166 should be pointed out that if the  $e$ - $\log \sigma'_v$  curves for the three stages (*i.e.* before pre-yielding,  
167 after pre-yielding and unloading) are linear, the  $C_c^*$  becomes the same as  $C_c$  and  $C_s^*$  becomes  
168 the same as  $C_s$ .

169 For the determination of secondary deformation coefficient  $C_{\alpha}$ , standard method is used

170 based on the  $e - \Delta \log t$  plot. The determination of  $C_c^*$ ,  $C_s^*$  and  $C_\alpha$  is illustrated in Figure 5.  
171 Note that  $C_\alpha = \Delta e / \Delta \log t$  is negative when loading and positive when unloading.

#### 172 173 **4.2. Relation between $C_\alpha$ and $\sigma'_v / \sigma'_c$**

174 Figure 6 shows the variation of  $C_\alpha$  versus the stress ratio  $\sigma'_v / \sigma'_c$  for all the six cores,  
175 identified by both low pressure and high pressure oedometer tests. It appears that during  
176 loading stage  $C_\alpha$  ranges mostly from 0 to 0.01 especially when the vertical effective stress is  
177 lower than the pre-consolidation stress. Some points beyond 0.01 can be observed when the  
178 stress ratio is greater than 2. For core Ess112,  $C_\alpha$  is very small and close to zero when the  
179 stress ratio is less than 1. For the unloading stages,  $C_\alpha$  ranges mostly from 0 to -0.01 for all  
180 tests when the stress ratio is greater than 0.1. On the contrary, when the stress ratio is less than  
181 0.1,  $C_\alpha$  is less than -0.01. These observations lead to conclude that more significant secondary  
182 consolidation takes place at higher stress ratios ( $\sigma'_v / \sigma'_c > 1$ ) upon loading and more  
183 significant secondary swelling takes place at lower stress ratios ( $\sigma'_v / \sigma'_c < 0.1$ ).

184 Except the results of core Ess112 during loading, all other results show that  $C_\alpha$  increases  
185 almost linearly with the stress ratio in the semi-logarithmic plane, for both loading and  
186 unloading stages. This is different from the results reported by other authors (Walker, 1969;  
187 Brook and Mark, 2000; Yilmaz and Saglamer, 2007; You, 1999; Zhu *et al.*, 2005; Shriako *et*  
188 *al.*, 2006; Suneel *et al.*, 2008; Costa and Ioannis, 2009) who observed that the relation  
189 between  $C_\alpha$  and  $\log \sigma'_v / \sigma'_c$  during loading is rather convex.

#### 190 191 **4.3. Relation between $C_c^*$ or $C_s^*$ and $C_\alpha$**

192 Figure 7 shows the variations of  $C_\alpha$  with  $C_c^*$  and  $C_s^*$  for all the cores. It appears that  $C_\alpha$   
193 increases linearly with  $C_c^*$ , with a slope ranging from 0.019 to 0.029. Moreover, this linear  
194 relation is independent of the state of consolidation: for a given core, all the points below and  
195 beyond  $\sigma'_c$  are on the same line.

196 Mesri *et al.* (1994) analyzed the secondary consolidation behaviour of many soils, and  
197 gave the correlation between the secondary consolidation coefficient ( $C_\alpha$ ) and the  
198 compression index  $C_c$  as shown in Table 1. From the results obtained on Boom clay, it  
199 appears that the ratio  $C_\alpha / C_c^*$  falls in a narrow range from 0.019 to 0.029. In order to have a  
200 mean value, all the results during loading are gathered in Figure 8, in terms of variations of  
201  $C_\alpha$  versus  $C_c^*$ . A value of 0.024 is identified for the ratio  $C_\alpha / C_c^*$ . Based on the classification  
202 criterion in Table 1, one can conclude that Boom clay falls in the zone of shake and mudstone  
203 whose  $C_\alpha / C_c^*$  value ranges from 0.02 to 0.04.

204 Figure 7 also shows that during unloading, a bi-linear relation between  $C_\alpha$  and  $C_s^*$  can be  
205 observed: the turning point at a  $C_s^*$  value around 0.1. This turning point can be considered as  
206 an indicator of changes from mechanical dominance to physical-chemical dominance in terms  
207 of volume changes: when  $C_s^*$  is less than the value at the turning point, the clay shows a  
208 mechanically dominated rebounding; by contrast, when  $C_s^*$  is larger than the value at the  
209 turning point, the clay shows a physico-chemically dominated swelling. This particular  
210 behaviour during unloading was also observed in other works: Delage *et al.* (2007) and Le *et*  
211 *al.* (2011) conducted compression tests on unsaturated Boom clay with suction monitoring,  
212 and observed that during unloading the soil suction increased slowly in the beginning and  
213 then rapidly when the vertical stress decreased down to a threshold value; Cui *et al.* (2002)

214 observed that the microstructure of a compacted bentonite/sand mixture started to change  
215 much more drastically when the suction was lower than 1 MPa; Cui *et al.* (2008) and Ye *et al.*  
216 (2009) observed that the unsaturated hydraulic behaviour of compacted bentonite-based  
217 materials under confined conditions changed drastically when the suction was lower than a  
218 threshold value.

219 All the data of  $C_\alpha$  versus  $C_s^*$  are gathered in Figure 9. In spite of the significant scatter, a  
220 bilinear relation can be still identified, with -0.024 and -0.26 as slopes. It is interesting to note  
221 that the absolute value of the slope of the first part (where the volume change behavior is  
222 supposed to be governed by the mechanical effect) is equal to the value of  $C_\alpha/C_c^*$  during  
223 loading (0.024). This observation confirms that the first part of unloading ( $C_s^* < 0.1$ ) gives  
224 rise to a mechanically dominated rebounding, because the volume change behavior during  
225 loading can be regarded as governed by the mechanical effects. The larger slope of the second  
226 part (0.26, when  $C_s^* > 0.1$ ) indicates a significant secondary swelling behavior compared to  
227 the mechanical secondary consolidation behavior.

228

## 229 5. Conclusion

230 Both low pressure and high pressure oedometer tests were carried out with loading and  
231 unloading on Boom clay samples taken by coring from Essen and Mol sites. The  $e$ -log  $\sigma'_v$  and  
232  $e$ -log  $t$  curves were plotted to determine the compression index  $C_c^*$ , swell index  $C_s^*$  and  
233 secondary deformation coefficient  $C_\alpha$ . Note that  $C_\alpha$  was determined for either loading stages  
234 (secondary consolidation) or unloading stages (secondary swelling). Different relations such  
235 as  $C_\alpha - \sigma'_v/\sigma'_c$ ,  $C_\alpha - C_c^*$ , and  $C_\alpha - C_s^*$  were analyzed. The following conclusions can be  
236 drawn:

- 237 (i)  $C_\alpha$  increases almost linearly with the stress ratio  $\sigma'_v/\sigma'_c$  in the semi-logarithmic plane, for  
238 both loading and unloading stages. This linear relation during loading was different from  
239 that observed by other researchers who concluded rather a convex relation for other soils.
- 240 (ii)  $C_\alpha$  increases linearly with  $C_c^*$ , with a slope of 0.024. In addition, this linear relation is  
241 independent of the state of consolidation. During unloading, a bi-linear relation between  
242  $C_\alpha$  and  $C_s^*$  was identified, with the turning point at a  $C_s^*$  value around 0.1 and the values  
243 of slopes of -0.024 and -0.26, respectively.
- 244 (iii) The two slopes of the  $C_\alpha - C_s^*$  curve relate to two different mechanisms: the first part  
245 ( $C_s^* < 0.1$ ) relates to a mechanically dominated rebounding whilst the second part ( $C_s^* >$   
246 0.1) relates to a physico-chemically dominated swelling. This observation was confirmed  
247 by the equality of the slopes for the first unloading part and the loading part (0.024),  
248 because the volume change behavior during loading can be regarded as governed by the  
249 mechanical effects.
- 250 (iv) According to the classification criterion defined by Mesri *et al.* (1994), Boom clay falls in  
251 the zone of shake or mudstone whose  $C_\alpha/C_c^*$  value ranges from 0.02 to 0.04.

252

## 253 Acknowledgements

254 ONDRAF/NIRAS (The Belgian Agency for Radioactive Waste and Enriched Fissile Materials)



255 is greatly acknowledged for its financial support. The first author is grateful to the National  
256 Science Foundation of China for its support (No 50908049).  
257

258 **References:**

- 259 Abdullah, W.S., Al-Zoubi, M.S. and Alshibli, K.A. 1997. On the physicochemical aspects of  
260 compacted clay compressibility. *Canadian Geotechnical Journal* 34, 551–559.
- 261 AFNOR, 1995. Sols : reconnaissance et essais: essai de gonflement à l'oedomètre,  
262 détermination des déformations par chargement de plusieurs éprouvettes. XP P 94-091.
- 263 AFNOR, 2005. Geotechnical investigating and testing, Laboratory testing of soils, Part 5:  
264 Incremental loading odometer test. XP CEN ISO/TS 17892-5.
- 265 Al-Shamrani, M., 1998. Application of the  $C_{\alpha}/C_c$  concept to secondary compression of  
266 Sabkha soils. *Canadian Geotechnical Journal* 35, 15-26.
- 267 Brook, E. and Mark A. A. 2000. Secondary compression of soft clay from Ballina. Proc.  
268 GeoEng 2000, Melbourne, Australia.
- 269 Costas, A.A. and Ioannis, N.G. 2009. A new model for the prediction of secondary  
270 consolidation index of low and medium plasticity clay soils. *European Journal of*  
271 *Scientific Research* 34(4), 542-549.
- 272 Cui, Y.J., Loiseau, C. and Delage, P. 2002. Microstructure changes of a confined swelling soil  
273 due to suction controlled hydration. Proc. of the Third Inter. Conf. on Unsaturated Soils  
274 UNSAT2002, Recife, vol. 2, 593-598.
- 275 Cui, Y.J., Tang, A.M., Loiseau, C. and Delage, P. 2008. Determining the unsaturated  
276 hydraulic conductivity of a compacted sand-bentonite under constant-volume and  
277 free-swell conditions. *Physics and Chemistry of the Earth* 33, S462-S471.
- 278 Cui, Y.J., Le, T.T., Tang, A.M., Delage, P., and Li, X.L. 2009. Investigating the time  
279 dependent behavior of Boom clay under thermomechanical loading. *Géotechnique* 59(4),  
280 319-329.
- 281 De Craen, M., Wemaere, I., Labat, S., and Van Geet, M. 2006. Geochemical analyses of Boom  
282 Clay pore water and underlying aquifers in the Essen-1 borehole. External report,  
283 SCK.CEN-ER-19, 06/MDC/P-47, Belgium
- 284 Delage, P., Le, T.T., Tang, A.M., Cui, Y.J., and Li, X.L. 2007. Suction effects in deep Boom  
285 clay samples. *Géotechnique* 57(2), 239-244.
- 286 Feng, T.W., Lee, J.Y. and Lee, Y.J. 2001. Consolidation behavior of a soft mud treated with  
287 small cement content, *Engineering Geology* 59, 327-335.
- 288 Feng, Z.G., and Zhu, J.G. 2009. Experimental study on secondary behavior of soft clays.  
289 *Journal of Hydraulic Engineering* 40(5), 583-588 (In Chinese).
- 290 Le, T.T., Cui, Y.J., Munoz, J.J., Delage, P. and Li, X.L. 2011. Studying the hydraulic and  
291 mechanical coupling in Boom clay using an oedometer equipped with a high capacity  
292 tensiometer. *Frontier of Architecture and Civil Engineering in China* 5(2), 160-170.
- 293 Mesri, G., and Castro, A. 1987. The  $C_{\alpha}/C_c$  concept and  $K_o$  during secondary compression.  
294 *Journal of Geotechnical Engineering Division* 112(3), 230-247.
- 295 Mesri, G., Kwan, L.D.O., and Feng, W.T. 1994. Settlement of embankment on soft clays. Proc.  
296 Of settlement 94, ASCE GSP 40, 8-56.
- 297 Mesri, G., Stark, T. D., Ajlouni, M. A., and Chen, C. S. 1997. Secondary compression of peat  
298 with or without surcharging. *Journal of the Geotechnical Engineering Division* 123(5),  
299 411-421.
- 300 Mesri, G., 2004. Primary compression and secondary compression, Proc. of Soil Behavior and  
301 Soft Ground Construction, ASCE GSP 119, 122-166.

302 Mesri, G. and Vardhanabhuti, B. 2009. Compression of granular materials. *Canadian*  
303 *Geotechnical Journal* 46, 369–392.

304 Shriako, H., Sugiyama, M., Tonosaki, A. and Akaishi, M. 2006. Secondary compression  
305 behavior in standard consolidation tests. *Proc. of Schl. Eng, Tokai University* 31, 27-32

306 Suneel, M., Park, L.K., and Chulim J. 2008. Compressibility characteristics of Korean marine  
307 clay. *Marine Georesources and Geotechnology* 26, 111–127.

308 Tan, Z.H., 2002. The behavior of compression and consolidation for clays. These of Taiwan  
309 Central University, China, 428 pp. (In Chinese).

310 Walker, L.K. and Raymond, G.P. 1968. The prediction of consolidation rates in a cemented  
311 clay. *Canadian Geotechnical Journal* 5(4), 192-216.

312 Walker, L.K., 1969. Secondary settlement in sensitive clays. *Canadian Geotechnical Journal*  
313 6(2), 219-222.

314 Ye, W.M., Cui, Y.J., Qian, L.X., Chen, B. 2009. An experimental study of the water transfer  
315 through compacted GMZ bentonite. *Engineering Geology* 108, 169 – 176.

316 Yilmaz, E. and Saglamer A. 2007. Evaluation of secondary compressibility of a soft clay. *The*  
317 *bulletin of the Istanbul Technical University* 54 (1), 7-13.

318 You, M.Q., 1999. Compression and consolidation behavior under different sampling, loading  
319 methods. Thesis of Taiwan Central University, China, 124 pp. (In Chinese).

320 Zhang, J.H., Miao, L.C. and Huang, X.M. 2005. Study on secondary consolidation  
321 deformation of soft clay. *Journal of Hydraulic Engineering* 36(1), 1-5 (In Chinese).

322 Zhu, H.H, Chen, X.P., Zhang F.J. and Huang, L.J. 2005. Consolidation behaviors of soft soil  
323 in Nansha, *Geotechnical Investigation and Surveying* 33(1), 1-3 (In Chinese).

324 **List of Tables**

325 Table 1. Soil classification according to the values  $C_\alpha/C_c$  (Mesri *et al.*, 1994)

326 Table 2. Geotechnical properties of the soil cores studied

327 **List of Figures**

328 Figure 1. Locations of the sampling sites (De Craen *et al.*, 2006)

329 Figure 2 Sketch of high pressure oedometer

330 Figure 3. Vertical effective stress and displacement versus elapsed time (Ess75Oedo1)

331 Figure 4. Compression curves from oedometer tests (Ess75Oedo1 and Ess75Oedo2)

332 Figure 5. Determination of parameters  $C_c^*$ ,  $C_s^*$  and  $C_\alpha$

333 Figure 6.  $C_\alpha$  versus stress ratio  $\sigma'_v/\sigma'_c$ . (a) Core Ess75; (b) Core Ess83; (c) Core Ess96; (d) Core  
334 Ess104; (e) Core 112; (f) Core Mol

335 Figure 7.  $C_\alpha$  versus  $C_c^*$  and  $C_s^*$ . (a) Core Ess75; (b) Core Ess83; (c) Core Ess96; (d) Core Ess104; (e)  
336 Core 112; (f) Core Mol

337 Figure 8.  $C_\alpha$  versus  $C_c^*$

338 Figure 9.  $C_\alpha$  versus  $C_s^*$

339

340

341 Table 1. Soil classification according to the values  $C_d/C_c$  (Mesri *et al.*, 1994)

Material	$C_d/C_c$
Granular soils including rockfill	$C_d/C_c = 0.02 \pm 0.01$
Shake and mudstone	$C_d/C_c = 0.03 \pm 0.01$
Inorganic clays and silts	$C_d/C_c = 0.04 \pm 0.01$
Organic clays and silts	$C_d/C_c = 0.05 \pm 0.01$
Peat and muskeg	$C_d/C_c = 0.06 \pm 0.01$

342

343

344 Table 2. Geotechnical properties of the soil cores studied

Core	Depth (m)	Member	$\rho_s$ (Mg/m <sup>3</sup> )	$w_L$ (%)	$w_p$ (%)	$I_p$ (%)	$w_0$ (%)	$e_0$
Ess75	218.91-219.91	Putte	2.65	78	33	45	29.7	0.785
Ess83	226.65-227.65	Putte	2.64	70	33	37	27.2	0.730
Ess96	239.62-240.62	Terhagen	2.68	69	33	36	26.5	0.715
Ess104	247.90-248.91	Terhagen	2.68	68	29	39	27.7	0.700
Ess112	255.92-256.93	Terhagen	2.67	62	25	37	27.3	0.755
Mol	223	Putte	2.67	68	26	42	23.6	0.625

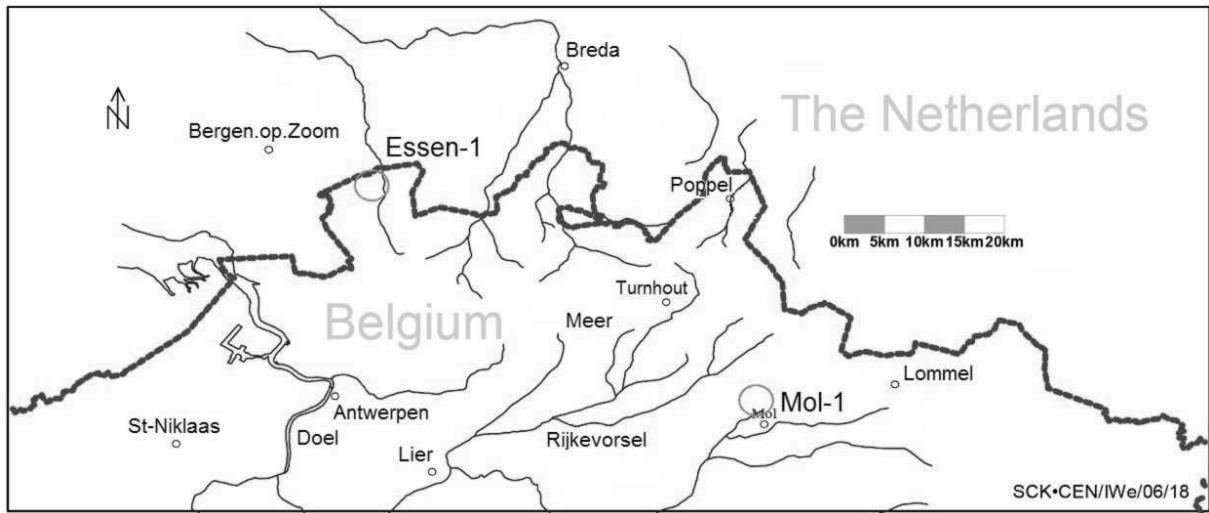

345  
346

Figure 1. Locations of the sampling sites (De Craen *et al.*, 2006)

347

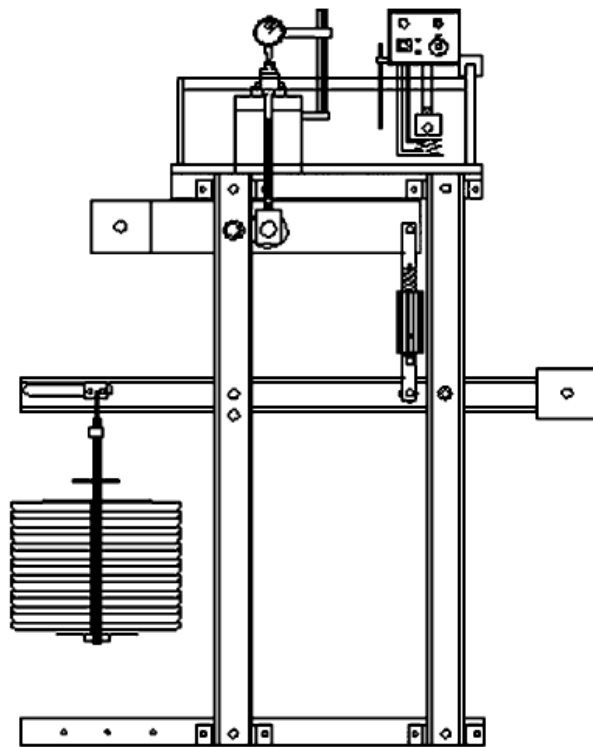

348

349

350

Figure 2 Sketch of high pressure oedometer



351

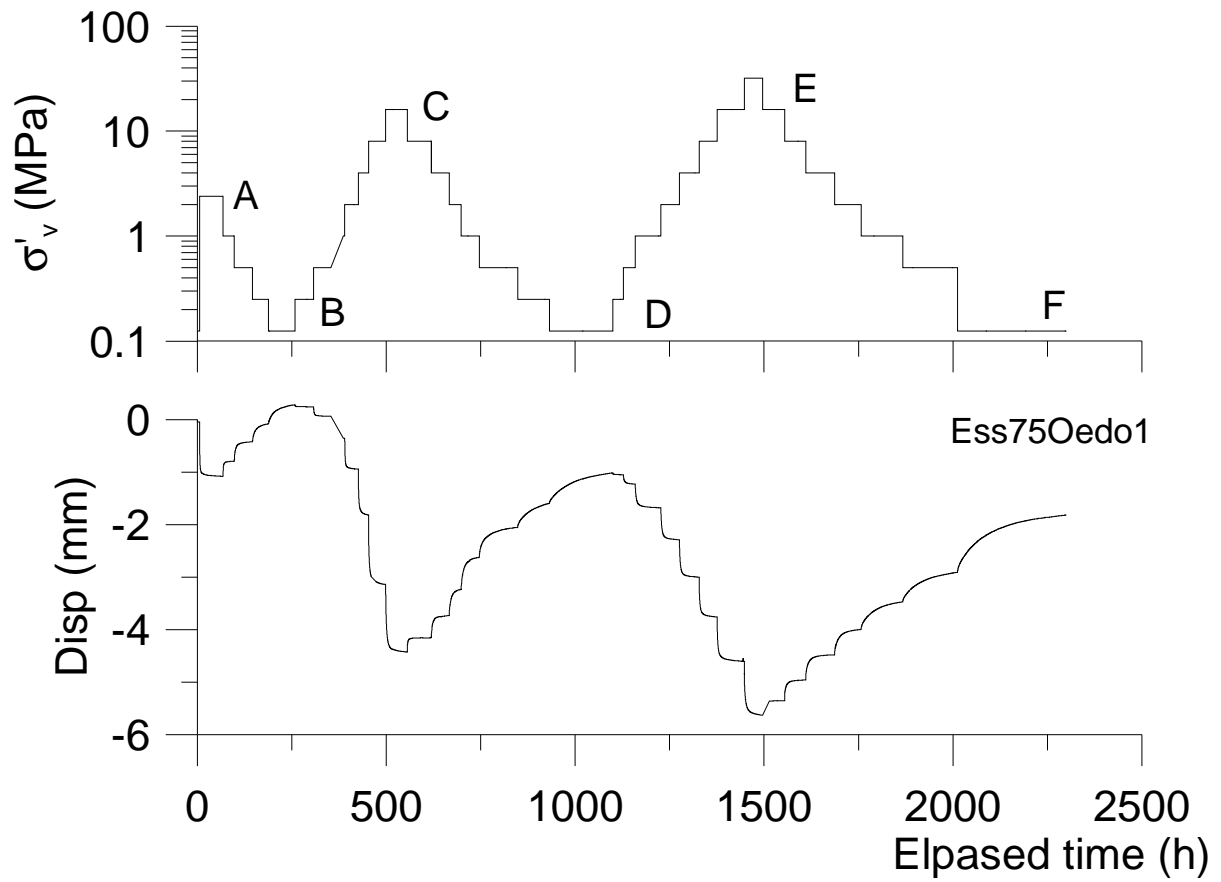

352

353

Figure 3. Vertical effective stress and displacement versus elapsed time (Ess75Oedo1)

354

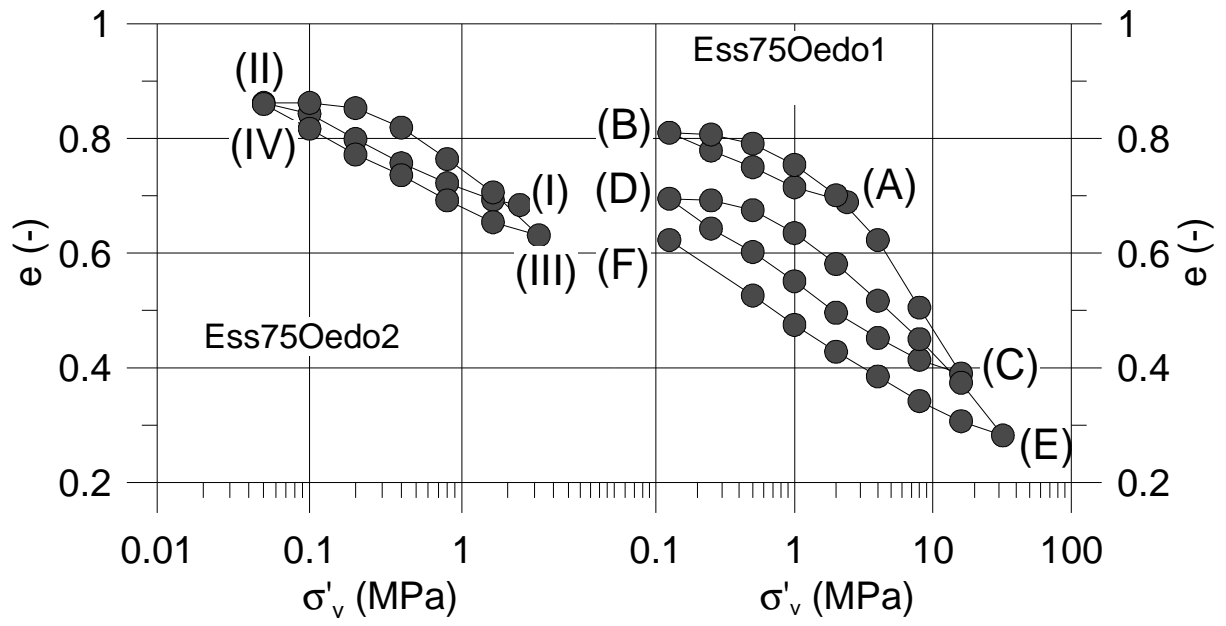

355

356

Figure 4. Compression curves from oedometer tests (Ess75Oedo1 and Ess75Oedo2)

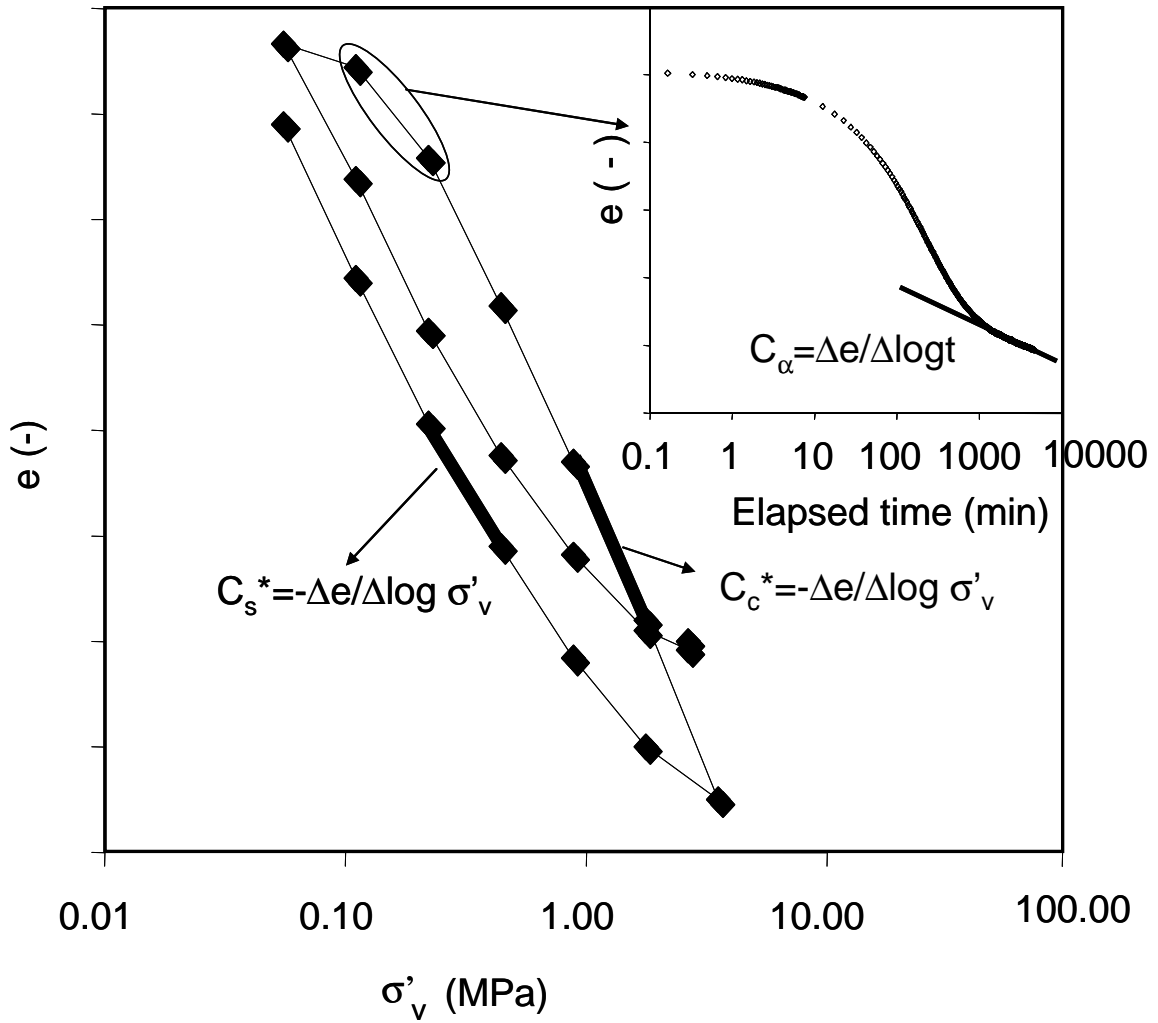

358  
359

Figure 5. Determination of parameters  $C_c^*$ ,  $C_s^*$  and  $C_\alpha$

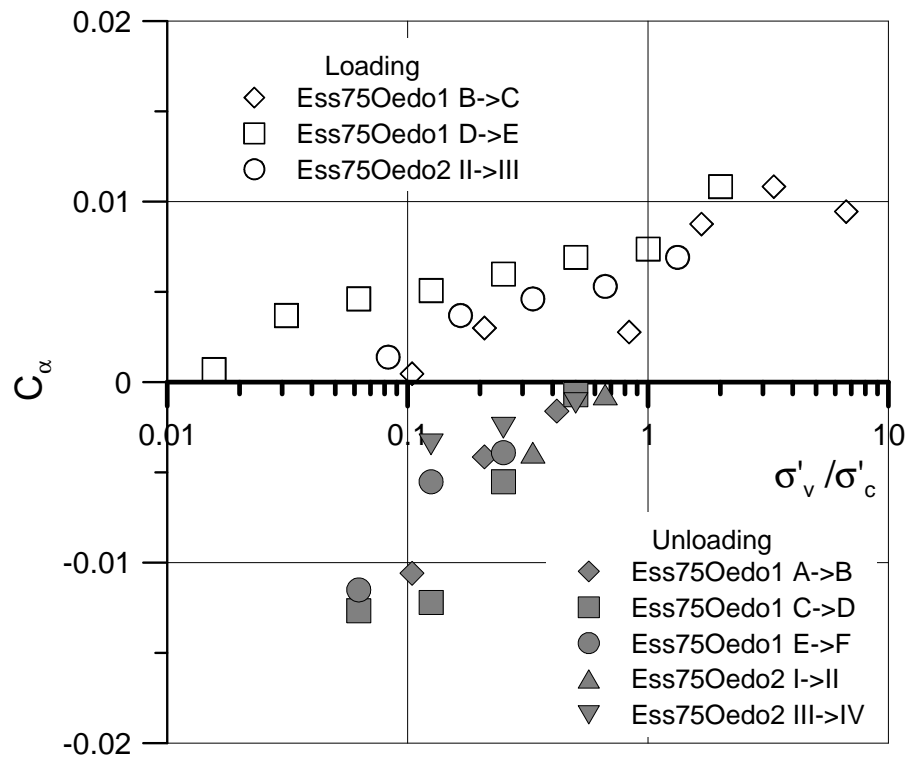

(a)

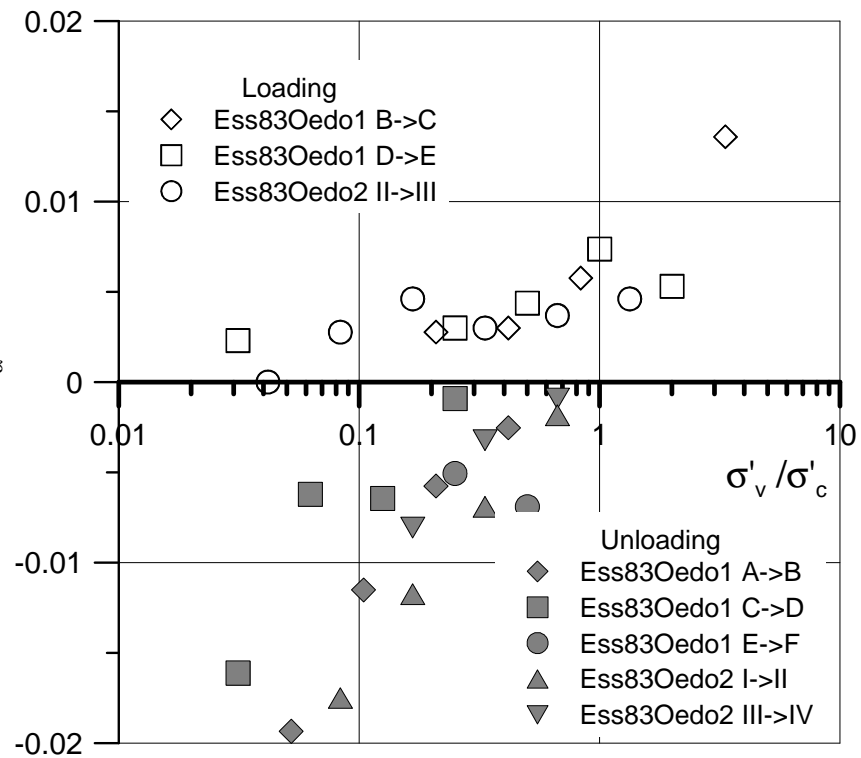

(b)

360

361

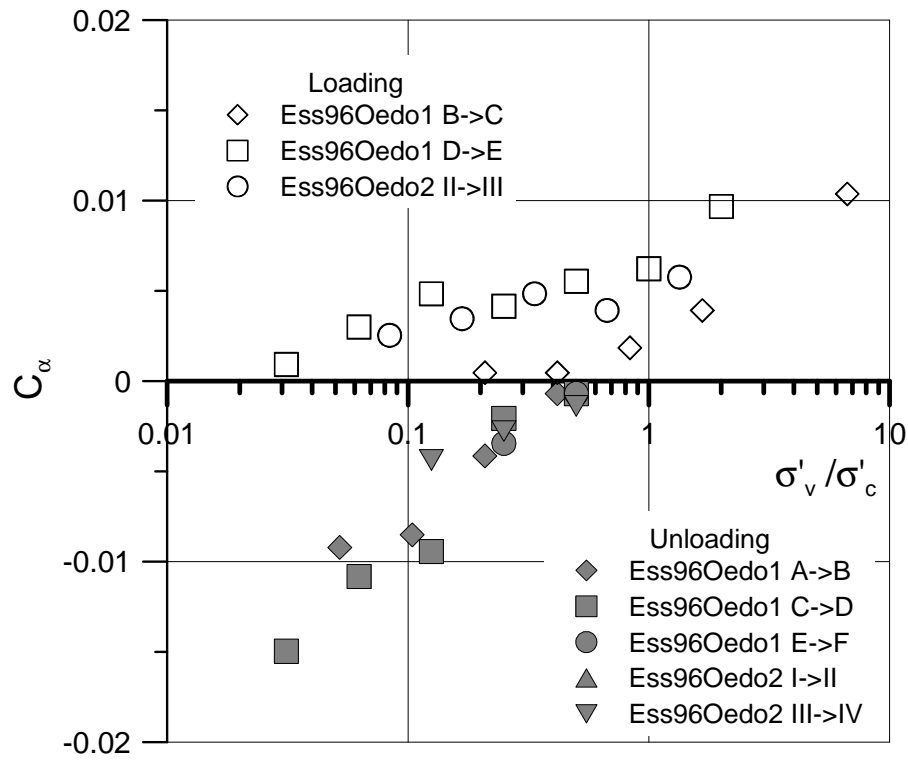

(c)

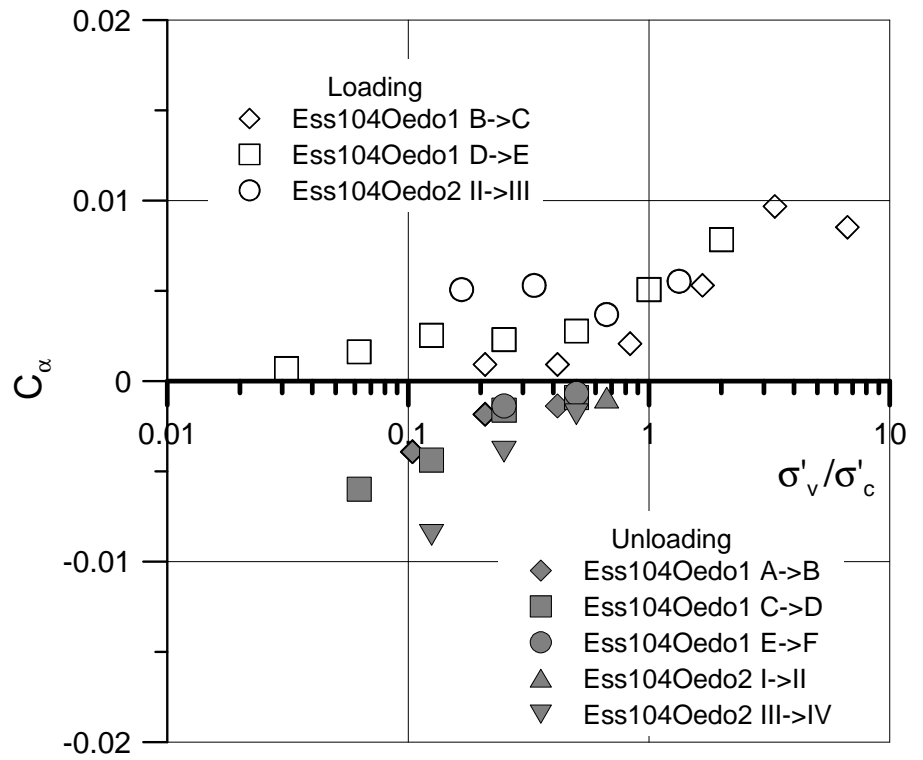

(d)

362

363

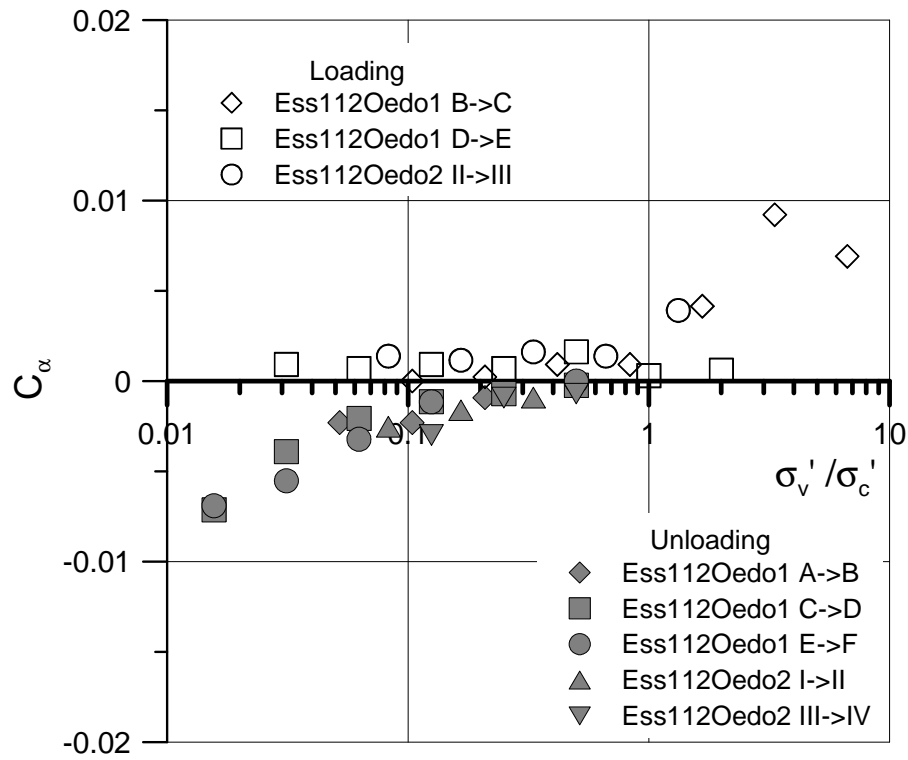

(e)

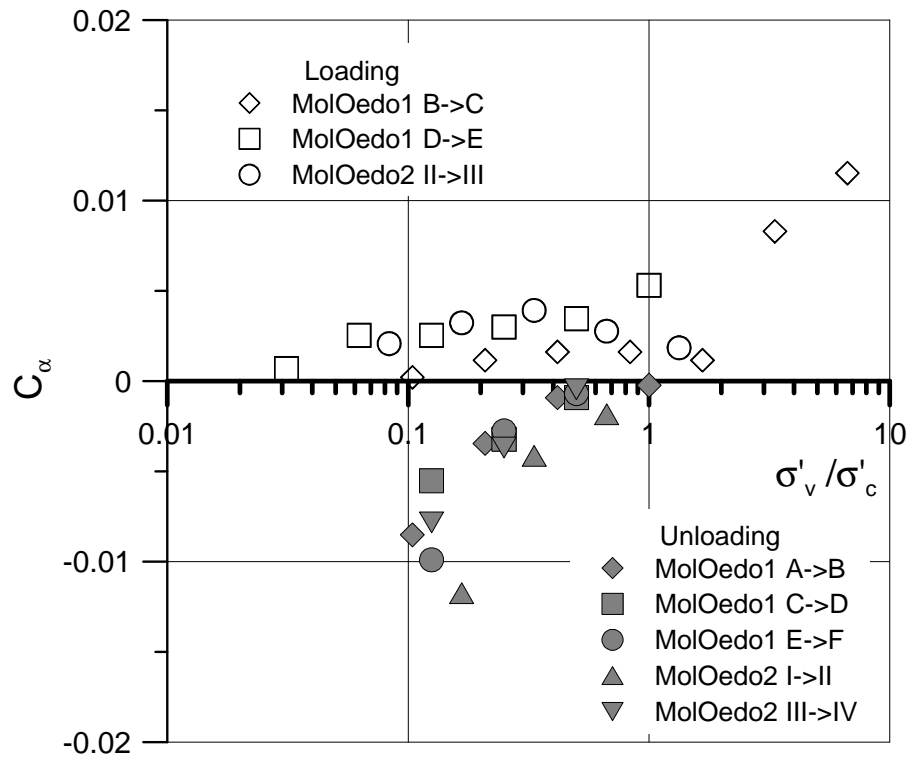

(f)

Figure 6.  $C_\alpha$  versus stress ratio  $\sigma'_v/\sigma'_c$ . (a) Core Ess75; (b) Core Ess83; (c) Core Ess96; (d) Core Ess104; (e) Core 112; (f) Core Mol

364  
365  
366  
367

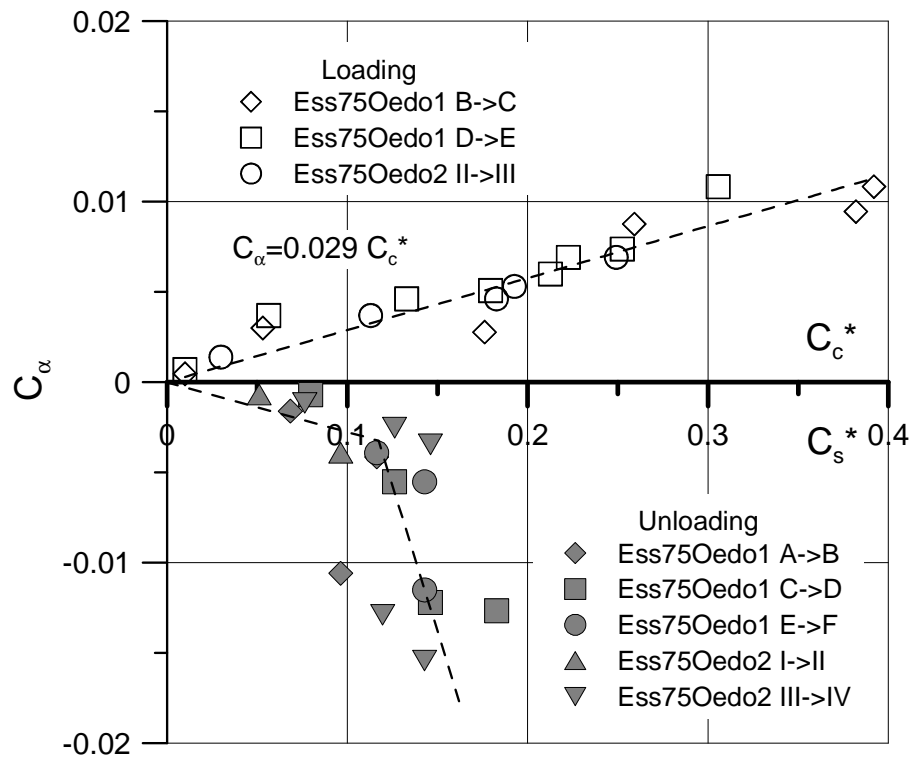

(a)

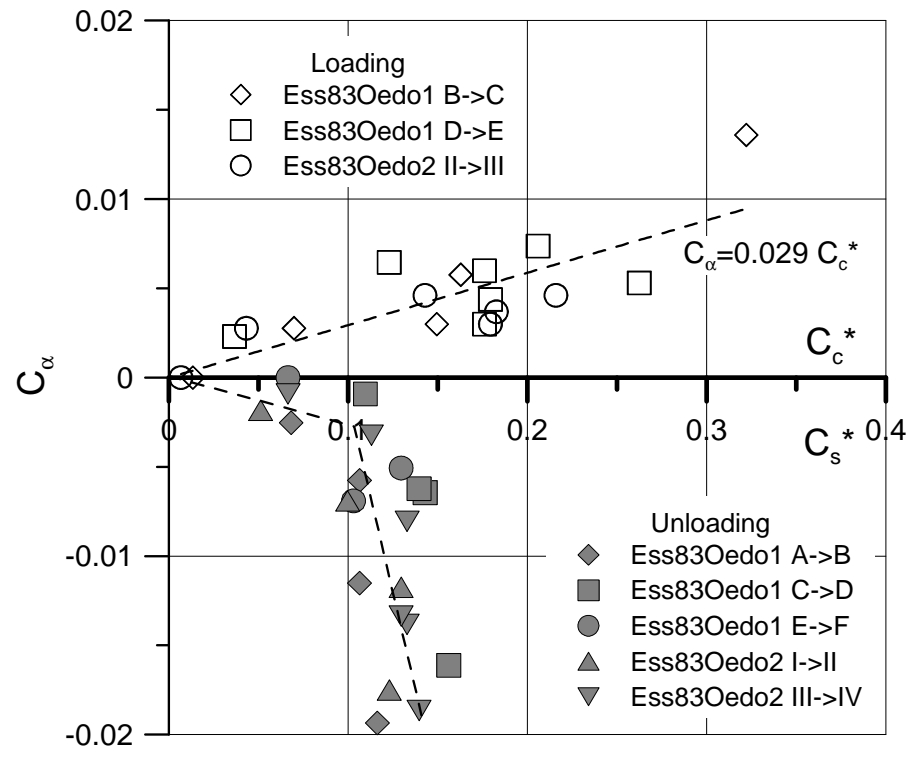

(b)

368

369

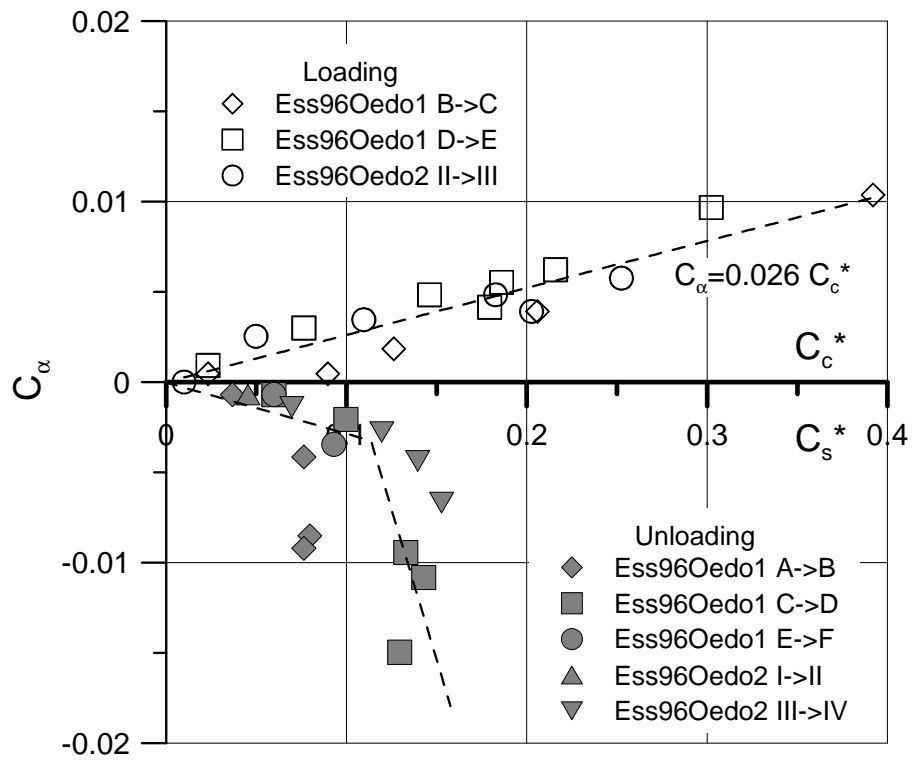

(c)

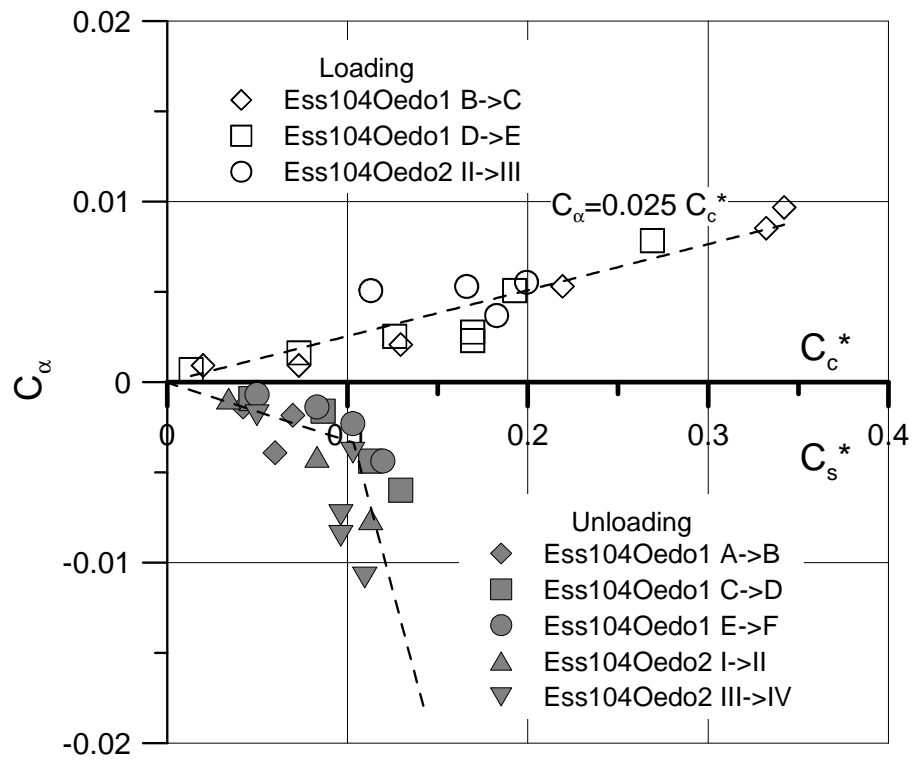

(d)

370

371



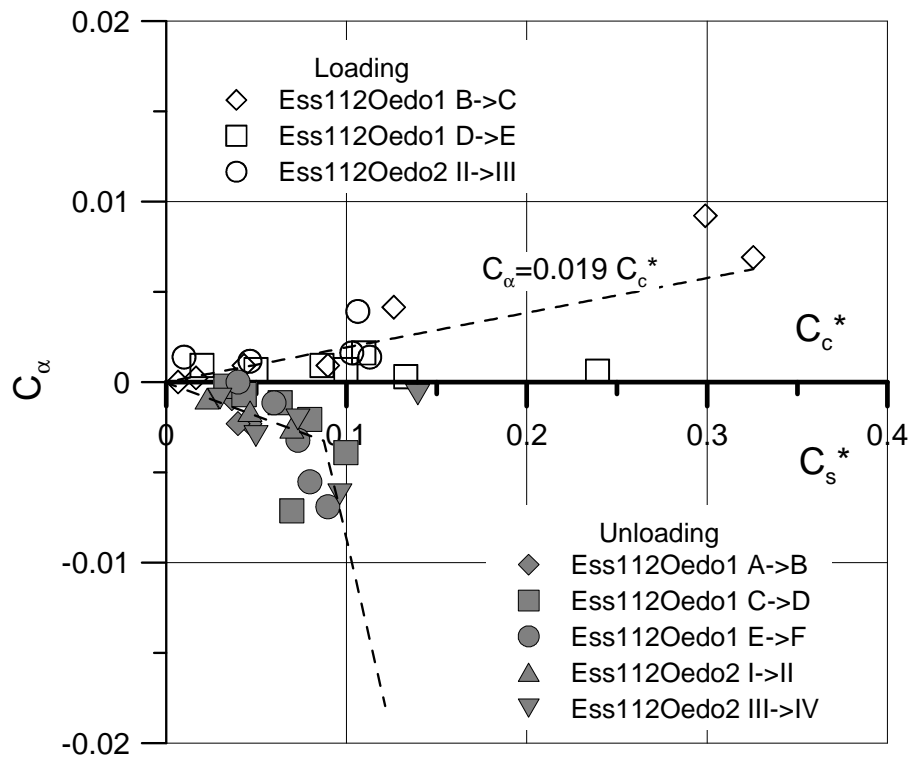

(e)

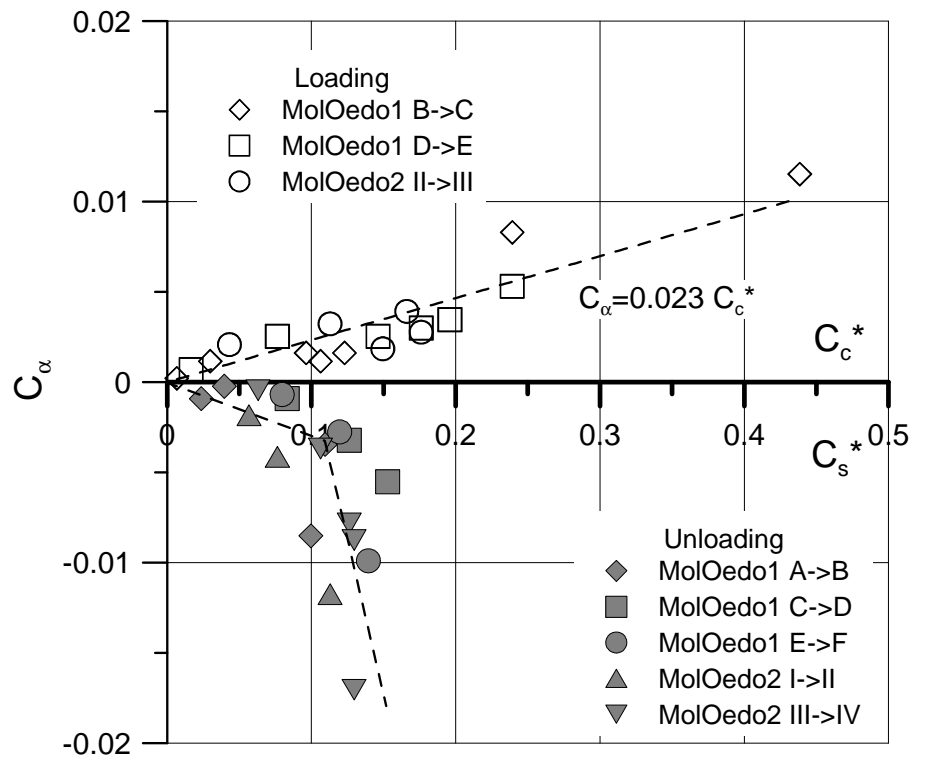

(f)

Figure 7.  $C_\alpha$  versus  $C_c^*$  and  $C_s^*$ . (a) Core Ess75; (b) Core Ess83; (c) Core Ess96; (d) Core Ess104; (e) Core 112; (f) Core Mol

372  
373  
374  
375

376

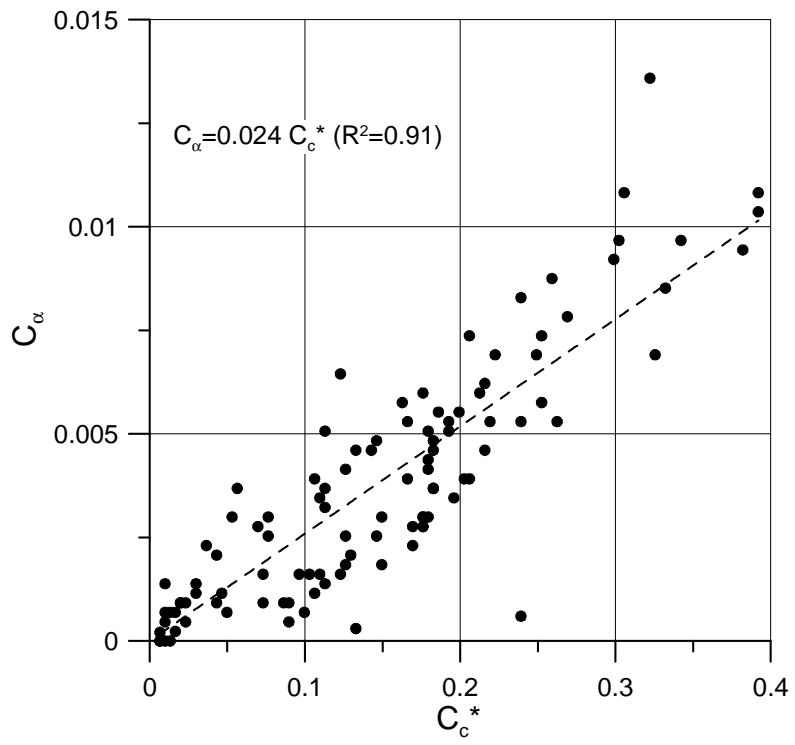

377

378

Figure 8.  $C_\alpha$  versus  $C_c^*$

379

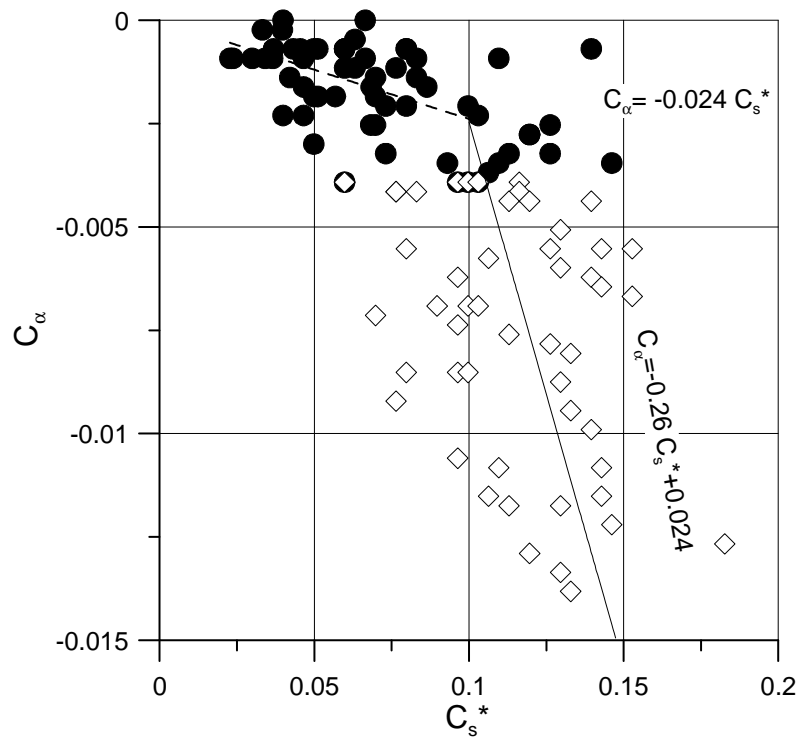

380

381

Figure 9.  $C_\alpha$  versus  $C_s^*$