



HAL
open science

Experimental study on the swelling behaviour of bentonite/claystone mixture

Qiong Wang, Anh Minh A.M. Tang, Yu-Jun Cui, Pierre Delage, Behrouz
Gatmiri

► **To cite this version:**

Qiong Wang, Anh Minh A.M. Tang, Yu-Jun Cui, Pierre Delage, Behrouz Gatmiri. Experimental study on the swelling behaviour of bentonite/claystone mixture. *Engineering Geology*, 2012, 124, pp.59-66. 10.1016/j.engeo.2011.10.003 . hal-00655761

HAL Id: hal-00655761

<https://enpc.hal.science/hal-00655761>

Submitted on 2 Jan 2012

HAL is a multi-disciplinary open access archive for the deposit and dissemination of scientific research documents, whether they are published or not. The documents may come from teaching and research institutions in France or abroad, or from public or private research centers.

L'archive ouverte pluridisciplinaire **HAL**, est destinée au dépôt et à la diffusion de documents scientifiques de niveau recherche, publiés ou non, émanant des établissements d'enseignement et de recherche français ou étrangers, des laboratoires publics ou privés.

1
2
3
4
5
6
7
8
9
10
11
12
13
14
15
16
17
18
19

Experimental study on the swelling behaviour of
bentonite/claystone mixture

Qiong Wang¹, Anh Minh Tang¹, Yu-Jun Cui¹, Pierre Delage¹, Behrouz Gatmiri²

¹ *Ecole des Ponts ParisTech, UR Navier/CERMES*

² *ANDRA, France*

Corresponding author:

Prof. Yu-Jun CUI

Ecole des Ponts ParisTech

6-8 av. Blaise Pascal, Cité Descartes, Champs-sur-Marne

F-77455 MARNE LA VALLEE

France

Telephone : +33 1 64 15 35 50

Fax : +33 1 64 15 35 62

E-mail : yujun.cui@enpc.fr

20 **Abstract**

21 A mixture of the MX80 bentonite and the Callovo-Oxfordian (COx) claystone were
22 investigated by carrying out a series of experiments including determination of the
23 swelling pressure of compacted samples by constant-volume method, pre-swell
24 method, zero-swell method and swell-consolidation method. Distilled water,
25 synthetic water and humidity controlled vapour were employed for hydration.
26 Results show that upon wetting the swelling pressure increases with decreasing
27 suction; however, there are no obvious effects of synthetic water chemistry and
28 hydration procedure on the swelling behaviour in both short and long terms. For the
29 same initial dry density, the swelling pressure decreases with increasing pre-swell
30 strain; whereas there is a well defined logarithmic relation between the swelling
31 pressure and final dry density of the sample regardless of the initial dry densities and
32 the experimental methods. It was also found that swelling pressure depends on the
33 loading-wetting conditions as a consequence of the different microstructure changes
34 occurred in different conditions. Furthermore, it was attempted to elaborate a general
35 relationship between the swelling pressure and the final dry density for various
36 reference bentonites.

37

38 **Keywords:** bentonite/claystone mixture; swelling pressure; water chemistry effect;
39 long term behaviour; final density; correlation.

40

41

42 **1 INTRODUCTION**

43 Deep geological repository is being considered for high-level radioactive waste (HLW)
44 in several countries such as China, Belgium, France, Germany, Japan, Sweden, etc. In
45 most cases, compacted bentonite-based materials are chosen as sealing/buffer
46 materials thanks to their low permeability, high swelling and high radionuclide
47 retardation capacities (Pusch, 1979; Yong et al., 1986; Villar et al., 2008).

48 Once the repository is closed and local groundwater conditions are re-established,
49 the water in the host rock formation will move to the repository. The bentonite-based
50 material absorbs water and swells, filling the technical voids as the gaps between the
51 bentonite bricks themselves, between the canister and the bricks, between bricks and
52 the host rock, as well as the fractures in the host rock due to excavation. After that,
53 the subsequent swelling is restrained by the host rock and swelling pressure develops.
54 From a mechanical point of view, in order to ensure the stability of the system, the
55 swelling pressure must be lower than the in situ minor stress: 7 MPa in the
56 Underground Research Laboratory (URL) of Bure site, France (Delege et al., 2010;
57 Tang et al., 2011a); 3-4 MPa at Tournemire site, France (Barnichon et al., 2009) and
58 4-5 MPa at Mol site, Belgium (Li et al., 2009), etc. As the compacted
59 bentonite-based material is a key component of a repository system, it governs the
60 overall behaviour of the whole system. Hence, a proper understanding of how the
61 compacted bentonite-based material behaves during hydration process is essential for

62 the assessment of the short and long term performance of the repository system.

63 The behavior of compacted bentonite-based material upon wetting has been widely
64 investigated, in terms of swelling properties (Pusch, 1982; Komine and Ogata, 1994,
65 2003, 2004a; Delage et al., 1998; Agus and Schanz, 2005; Komine et al., 2009);
66 hydraulic behaviour under saturated state (Kenney et al., 1992; Dixon et al., 1999;
67 Komine, 2004b;) and unsaturated state (Borgesson et al., 1985, 2001; Kröhn, 2003;
68 Lemaire et al., 2004; Loiseau et al., 2002; Cui et al., 2008). There are also many
69 studies on the effect of temperature (Komine and Ogata, 1998; Romero et al., 2001;
70 Villar and Lloret, 2004; Tang et al., 2005; Tang et al., 2007; Tang et al., 2008a; Tang
71 and Cui, 2009) and water chemistry of the saturating fluid (Pusch 2001a, Karland et
72 al., 2005; Suzuki et al., 2005; Komine et al., 2009) on the hydro-mechanical (HM)
73 behaviour.

74 For the swelling properties, it has been found that the swelling pressure determined
75 in the laboratory can be affected by the experimental methods (Sridharan et al., 1986;
76 Tang et al., 2011b). Normally, different methods give different values of swelling
77 pressure due to the difference in the loading and wetting conditions in each method
78 (Abdullah et al., 1998, 1999). In addition, the swelling properties depend on the
79 initial dry density and water content of the soil specimen. The higher the initial dry
80 density, the higher the swelling pressure or the higher the swelling strain; the
81 swelling strain decreases with increasing initial water content, but the swelling
82 pressure seems not to be affected by the initial water content (Komine et al., 1994;
83 Villar et al., 2008). The swelling properties can be also affected by the chemical
84 composition of the saturating fluid: the swelling capacity of the bentonite decreases
85 with the increase in salinity of saturating fluid, although this influence becomes less
86 significant for higher densities (Pusch, 1980; Sugita et al., 2003; Karland et al.,
87 2005; Castellanos et al., 2008; Siddiqua et al., 2011). Moreover, studies on the aging
88 effects on the swelling behavior show that the swelling potential may decrease with
89 time due to the rearrangement of clay particles with time (Nalzeny et al., 1967; Day
90 et al., 1994; Subba Rao et al., 2003; Delage et al., 2006).

91 Very often, bentonite/sand mixtures are considered for the reasons of good control of
92 swelling pressure, large thermal conductivity and a better mechanical resistance. In
93 France, the mixture of bentonite and crushed Callovo-Oxfordian (COx) claystone
94 excavated from the Bure site of the ANDRA URL (-490 m, North-eastern France)
95 was proposed as a possible sealing and backfill material. This choice has several
96 advantages: (i) it is more economical by using local excavated claystone; (ii) the
97 negative impacts on the environment is reduced by recycling the excavated material;
98 (iii) there is better compatibility of mineralogical and chemical compositions with
99 host rock, allowing reduction of complex physico-chemical interaction with the host
100 rock (Andra, 2005; Tang et al., 2011a; Tang et al., 2011b). On the other hand, unlike
101 relatively inert sand, claystone contains clay minerals and interaction between
102 claystone and bentonite may occur, affecting the hydro-mechanical behaviour of the
103 compacted mixture. Moreover, this interaction can be of long term. Particular

104 attention should be paid to this aspect.

105 This study focuses on the swelling properties of the mixture MX80
106 bentonite/crushed Cox claystone. A series of swelling tests were performed under
107 constant temperature ($20\pm 1^\circ\text{C}$). The influences of water chemistry, hydration
108 procedure and duration, pre-existing technical void and loading-wetting paths on the
109 swelling pressure of compacted samples were investigated. Emphasis was put on the
110 relationship between the swelling pressure and the dry density of bentonite.

111

112 **2 MATERIALS AND METHODS**

113 2.1 Materials

114 The commercial MX80 bentonite from Wyoming, USA, was used. Table 1 lists its
115 physical parameters. It appears that the proportion of montmorillonite is dominant in
116 the bentonite (92 %); it has an average specific gravity of 2.76, a liquid limit of
117 520%, and a plastic limit of 42%. The grain size distribution determined by
118 sedimentation in Figure 1 shows that 84% grains are smaller than $2\ \mu\text{m}$ (clay
119 fraction).

120 Callovo-Oxfordian (COx) claystone taken from the Bure site of the ANDRA URL
121 was studied. It contains 40–45% clay minerals (mainly interstratified minerals
122 illite–smectite), 20–30% carbonates and 20–30% quartz and feldspar (Hoteit et al.,
123 2000; Lebon and Ghoreychi, 2000; Zhang et al., 2004). The specific gravity is 2.70.
124 The excavated claystone was air-dried ($w = 2.64\%$) and crushed to powder. The
125 grain size distribution determined by sedimentation is presented in Figure 1. It
126 confirms that 40% grains are clays ($< 2\ \mu\text{m}$).

127 Both distilled water and synthetic water having the same chemical composition as
128 the site water (see Table 2) were used.

129 2.2 Samples preparation

130 All the tests in this study were performed on samples of compacted
131 bentonite/claystone mixture with a bentonite content of 70 % in dry mass. Bentonite
132 and claystone powders with the initial water contents of 11.8 % and 2.64 %
133 respectively, were used for the samples preparation. Their grain size distributions
134 were determined by sieving and are presented in Figure 1.

135 Samples were statically compacted in an oedometer cell (38 or 70 mm in internal
136 diameter) at a controlled rate of 0.05 mm/min. A load transducer was used for axial
137 force monitoring, and a micrometer dial gauge was used for axial displacement
138 monitoring. After compaction, the specimen was carefully transferred into the
139 hydration cell (with the same diameter as the oedometer cell) by connecting the
140 bottom of the two cells together. This procedure allows the lateral stress released
141 without significant increase in sample diameter.

142 2.3 Experimental methods

143 Various methods were used to determine the swelling pressure upon wetting. The
144 stress paths of these methods are presented in Figure 2.

145 For the “constant-volume” method (stress path OA), the devices presented in Figure
146 3 and Figure 4 were used. The constant-volume cell includes three parts (Figure 3,
147 Tang et al., 2011b): (1) the bottom part containing a porous stone and a drainage
148 system; (2) the middle cell (70 mm inner diameter) used to prevent radial swelling,
149 with two air outlets; (3) the top part incorporating a total pressure sensor to monitor
150 the swelling pressure. Figure 4 presents the setup used to control the suction in the
151 soil sample using the vapour equilibrium technique (see Delage et al., 1998 for more
152 details). When flooding the soil sample, this system was removed and the water inlet
153 was connected to a water reservoir.

154

155 For the “pre-swell” method (stress path OBB’), the sample was first allowed to swell
156 freely in the axial direction to a certain value (Point B, noted as “pre-swell”), then
157 the piston was fixed permitting the generation of swelling pressure that was
158 monitored by the load transducer. This method was used to investigate the effect of
159 pre-existing technical voids (simulated by the pre-swell allowed in the tests) on the
160 swelling pressure.

161 For the “zero-swell” and “swell-consolidation” methods, the equipment employed
162 was a conventional oedometer (Basma et al., 1995; Nagaraj et al., 2009). Firstly, a
163 low initial load of 0.1 MPa was exerted on the specimen prior to water flooding. As
164 the specimen wetted up it attempted to swell. When the swell exceeded 10 μm
165 (equivalent to 0.1%), additional pressure was added in small increment to bring the
166 volume of soil specimen back to its initial value (Basma et al., 1995; Abdullah et al.,
167 1998, 1999; Attom et al., 2001). This operation was repeated until the specimen
168 ceased to swell (OCC’ in Figure 2). The swelling pressure was defined as the stress
169 under which no more swelling strain was observed.

170 The “swell-consolidation” method consists of re-saturating the soil under a low
171 vertical pressure of 0.1 MPa until full swell was achieved. After swell completion,
172 standard consolidation test was conducted. The pressure required to compress the
173 specimen back to its original void ratio is defined as the swelling pressure (Basma et
174 al., 1995; Abdullah et al., 1998, 1999; Agus, 2005). The corresponding stress path
175 ODD’ is shown in Figure 2. In this path, point D also represents the maximum
176 swelling strain of the sample.

177 The experimental programme is shown in Table 3. Three tests were performed using
178 the constant-volume method to study the effect of water chemistry and the hydration
179 procedure (CV01, CV02 and CV03). Distilled water and synthetic water was used in
180 test CV01 and CV02, respectively. In test CV03, three suctions (57 MPa, 38 MPa

181 and 12.6 MPa) were first applied step by step using vapor equilibrium technique (as
182 shown in Figure 4), prior to distilled water flooding in the last stage.

183 Four tests were performed by pre-swell method to study the influence of pre-existing
184 technical voids on the swelling pressure (PS01 – PS04). Different pre-swells were
185 allowed before measurement of the swelling pressure. Note that for test PS04 the
186 sample was allowed to swell freely to reach the maximum pre-swell strain.

187

188 Two other tests were conducted using zero-swell method (ZSO1) and
189 swell-consolidation method (SCO1), respectively, for analyzing the influence of
190 loading-wetting paths followed in different experimental methods.

191

192 As it can be seen in Table 3, the tests conducted have in general long duration, from
193 80 h to one year.

194

195 **3 EXPERIMENTAL RESULTS**

196 Figure 5 presents the results from tests CV01 and CV02 with distilled water and
197 synthetic water respectively, during the first 100 h. The two curves are very similar,
198 showing negligible effect of water chemistry (in the range considered). With water
199 infiltration, swelling pressure increased first very quickly; after about 20 h the
200 swelling pressure reached a first stability stage. At 32 h, the swelling pressure
201 restarted to increase and it reached a second stability stage at 100 h. The final values
202 are 4.30 MPa and 4.37 MPa for CV01 and CV02, respectively.

203 The results of test CV03 is presented in Figure 6. The initial suction of sample was
204 about 90 MPa (measured by a relative humidity sensor on the soil specimen after the
205 compaction and prior to the installation in the cell). The application of the first
206 suction of 57 MPa resulted in a swelling pressure of 0.57 MPa. Then, the second
207 suction of 38 MPa was applied and the swelling pressure reached 1.43 MPa. With
208 the third suction of 12.6 MPa the swelling pressure increased to 2.61 MPa. The zero
209 suction applied by distilled water led the sample to a maximum value of 4.39 MPa
210 swelling pressure. This value is very close to that from test CV01 (4.30 MPa) and
211 CV02 (4.37 MPa) in which the samples were flooded directly with water. This
212 means there is no kinematic effect on the swelling pressure for the studied mixture.

213 Figure 7 presents the relationship between the swelling pressure (σ_s in MPa) and the
214 suction (s in MPa), with the values obtained from test CV03. An exponential
215 function can be used to satisfactorily describe this relationship:

216
$$\sigma_s = 4.9908 \times 10^{-0.0178s} \quad (\text{Eq.1})$$

217 In Figure 8, the whole results from the three tests CV01, CV02 and CV03 during one
218 year are presented. It appears that after a long period of one year, there was just a

219 slight decrease of swelling pressure and the values for the three samples still remain
220 very close (4.23MPa, 4.32MPa and 4.29MPa for test CV01, CV02 and CV03,
221 respectively). This shows a negligible effect of any bentonite-claystone interaction
222 on the swelling pressure.

223 The evolution of swelling pressure for the specimens having the same initial dry
224 density of 1.90 Mg/m^3 with different pre-swells is presented in Figure 9. An
225 expected significant decrease of swelling pressure with increasing pre-swell is
226 observed. For the pre-swells of 10, 20 and 25%, the swelling pressures obtained are
227 5.38, 2.03 and 0.7 MPa, respectively. Note that the maximum swelling strain from
228 test PS04 reaches 43 %.

229 The results from test SCO1 using the swell-consolidation method are presented in
230 Figure 10. When wetting up, the sample swelled under a low vertical pressure of
231 0.1 MPa and the maximum swelling strain reached 41.76%. Further compression
232 gave a normal consolidation curve that allows the determination of the swelling
233 pressure: $\sigma_s = 22.20 \text{ MPa}$.

234 For test ZSO1 (zero-swell method) on a sample at an initial dry density of
235 1.70 Mg/m^3 , a vertical stress of 4.38 MPa was needed to keep the void ratio constant.
236 By definition, this value is the swelling pressure by this method.

237 From the results in Figure 9, the swelling pressure is plotted versus the pre-swell
238 strain in Figure 11. The maximum pre-swell of test PS04 and the swelling strain in
239 SCO1 (swell consolidation method) are also presented in this figure. Note that all
240 specimens had the same initial dry density of 1.90 Mg/m^3 and all flooded with
241 synthetic water. It appears that the result of SCO1 is close to that of PS04 (free
242 swell), showing a good repeatability of the free-swell tests. A linear correlation can
243 be obtained between the swelling strain allowed (ε in %) and the logarithm of
244 swelling pressure (σ_s in MPa):

$$245 \quad \varepsilon = -19.32Lg(\sigma_s) + 23.946 \quad (\text{Eq.2})$$

246 In Figure 12, the swelling pressure determined by the pre-swell method (PS01, PS02,
247 PS03, PS04), constant-volume method (CV02), zero swell method (ZSO1) are
248 plotted in the plane of void ratio/logarithm of vertical stress, together with the
249 consolidation line from test SCO1. Point O and O' correspond to the initial states of
250 the samples at a dry density of 1.90 Mg/m^3 (PS01, PS02, PS03, PS04 and SCO1)
251 and 1.70 Mg/m^3 (CV02 and ZSO1), respectively. It can be noted that at the same
252 void ratio, the vertical stress of the consolidation curve (SCO1) is slightly higher
253 than the swelling pressure determined by other methods.

254 Figure 13 shows the measured swelling pressure versus the final dry density of the
255 bentonite/claystone mixture for all the tests. Note that these tests have been
256 performed with two different initial dry densities ($\rho_{di} = 1.90 \text{ Mg/m}^3$ for tests PS01,

257 PS02, PS03, PS04, SCO1; and $\rho_{di} = 1.70 \text{ Mg/m}^3$ for tests CV02, ZSO1), and using
 258 various methods (see Table 3). In spite of this, a unique correlation seems enough to
 259 describe the relationship between the swelling pressure σ_s (MPa) and the final dry
 260 density of the mixture ρ_{dm} (Mg/m^3):

$$261 \quad \sigma_s = 4.8 \times 10^{-7} \exp^{9.41\rho_{dm}} \quad \text{Eq.3}$$

262 This shows that the swelling pressure of the compacted claystone/bentonite mixture
 263 is mainly dependent on the final dry density of the mixture. For a deeper analysis on
 264 the role of the bentonite itself in the swelling pressure development of the bentonite-
 265 based mixutre, the dry density of bentonite (ρ_{db}) was considered by assuming that the
 266 water content of additives (claystone in this study) kept constant, while the water
 267 added during the tests was totally absorbed by bentonite. The volume of bentonite
 268 (V_b) is the difference between the total volume (V) and the volume of claystone (soil
 269 particles and water inside). The bentonite dry density can be calculated by the
 270 following equation:

$$271 \quad \rho_{db} = \frac{(B/100)\rho_m G_{sa}}{G_{sa}(1 + w_m/100) - \rho_m(1 - B/100)(1 + w_a)} \quad \text{(Eq.4)}$$

272 where ρ_m (Mg/m^3) is the mixture density; B (%) is the bentonite content (in dry mass)
 273 in the mixture; w_m is the water content of the mixture; w_a is the initial water content
 274 of claystone; G_{sa} is the specific gravity of claystone. In this study, $w_a = 2.64\%$, $B =$
 275 70% , $G_{sa} = 2.70$.

276 Using Eq. 4, the results shown in Figure 13 were re-analysed and Figure 15 shows
 277 the variations of swelling pressure with the final dry density of bentonite. In the
 278 same figure, the results collected from other works on the MX80/sand mixture
 279 (Karland et al., 2008) and the pure MX80 bentonite (Karnland et al., 2008; Dixon et
 280 al., 1996) are also presented. A very similar relationship is obtained for the different
 281 data sets, showing that the swelling pressure mainly depends on the final dry density
 282 of bentonite, sand and claystone being both inactive components in the mixtures for
 283 the swelling pressure development.

284

285 To further investigate this point, results on other reference bentonites were collected
 286 and analysed in the same fashion. Figure 15 shows the variations of swelling
 287 pressure with the final dry density of MX80 (from Figure 14), FoCa7 (Imbert et al.,
 288 2006), FEBEX (Villar et al., 2002) and Kunigel V1 (Dixon et al., 1996). It appears
 289 that for each bentonite, there is a unique relationship between the swelling pressure
 290 and the final dry density of bentonite. However, the relationships are not the same. A
 291 general expression can be proposed:

$$292 \quad \sigma_s = \alpha \times \exp^{\beta\rho_{db}} \quad \text{Eq.5}$$

293 where α and β are the two constants.

294

295 Table 4 shows the values of α and β for the four bentonites analysed. In the table, the
296 mineralogy of these materials is also presented. The difference of parameters can be
297 related to the different types of clay (i.e. montmorillonite, beidellite and saponite,
298 etc), montmorillonite content and type of exchangeable cations (i.e. calcium or
299 sodium). In general, the swelling capacity of sodium bentonite is higher than that of
300 calcium bentonite; with the same type of exchangeable cations, a larger
301 montmorillonite content leads to a higher swelling pressure.
302

303 **5 DISCUSSION**

304 It has been observed that the effect of the chemistry of Bure site water on the swelling
305 pressure is negligible. However, it is generally accepted that the swelling pressure
306 decreases with the increase in salinity of the pore-water, although this decrease
307 becomes less significant in case of high density (Karnland et al., 2005; Castellanos et
308 al., 2008; Siddiqua et al., 2011; Komine et al., 2009). Castellanos et al. (2008)
309 reported that the swelling pressure of the FEBEX bentonite compacted to a dry
310 density of 1.65 g/cm^3 decreases to almost half its initial value when 2 mol/L CaCl_2
311 and NaCl/L solutions are used as saturating fluids; At low salinities (0.004 mol/L,
312 granitic water), the swelling pressure of bentonite seems not to be affected by the
313 salinity changes at a dry density ranging from 1.40 to 1.70 Mg/m^3 . It appears that for
314 the studied bentonite/claystone mixture, the high density and the low salinity of
315 synthetic water together resulted in the negligible effect of water chemistry on the
316 swelling pressure. This can be explained by the theory of cations filtration (Komine et
317 al., 2009). For high dry density of bentonite-based materials, the distances between
318 the montmorillonite mineral layers being very small, these layers can filter the cations
319 in the solution; on the contrary, in the case of low dry density, the cations in solution
320 can infiltrate easily into the montmorillonite mineral layers due to the larger distances
321 between them, thus affecting the swelling behaviour.

322 For the sample wetted with suction control (CV03), an exponential function was
323 found between the swelling pressure and the suction applied. This can be explained
324 as follows. As clay samples are exposed to humid water vapour, water molecules
325 first migrate into the open channels and adsorbed on the exposed mineral surface
326 (Pusch, 2001b; Arifin, 2008), then move to elementary clay layers. The number of
327 water molecules absorbed by the clay layers depends on the relative humidity or
328 suction (Pusch, 2001b; Saiyouri et al., 2004; Delage, 2006), and this number of
329 water molecules defines the swelling pressure of the sample. Therefore the swelling
330 pressure is suction or relative humidity dependent. After the sample was flooded
331 with distilled water, the maximum swelling pressure was found close to that obtained
332 by water-flooding the sample directly, indicating the negligible effect of wetting
333 procedure. This phenomenon can be explained by the mechanism identified by Cui
334 et al. (2002): when hydrating by decreasing suction (57-38-12.6 MPa) under
335 confined conditions, the size of macro-pores was progressively decreased, whereas
336 the micro-pores remained almost un-affected. The micro-pores started to change

337 only when the water saturation is approached. This suggests that step-wetting by
338 suction control and direct saturation by water flooding may lead to similar final
339 microstructures, thus similar final swelling pressures.

340 Yang et al. (2008) reported that the mineralogical composition of the bentonite will
341 not be stable under the chemistry fluid infiltration and its properties may degrade
342 over long time periods. Moreover, for the bentonite/claystone mixture used in this
343 study, interaction of claystone with water and bentonite was suspected. This justifies
344 the long swelling tests kept over one year. However, no any significant effects were
345 observed on the swelling pressure. It is possible that one year test is not long enough
346 and this point should be studied further with longer tests, giving the long-term nature
347 of the nuclear waste disposal.

348 A linear correlation was observed between the pre-swelling strain and the logarithm of
349 swelling pressure for the samples with the same initial dry density. This line defines
350 the limit of swelling potential: the samples at the same initial state followed different
351 stress-volume paths until reached this limit and then no further expansion occurred.
352 This is consistent with the conclusion of Villar et al. (2008) and Siemens et al. (2009)
353 who found a similar relationship between swelling strain and swelling pressure. It can
354 be seen that the final state of specimen governed the swelling pressure: for the
355 samples with the same initial state, different pre-swelling strains led to different final
356 dry densities and thus resulted in different swelling pressure. Moreover, a unique
357 relationship was observed between the swelling pressure and the final dry density of
358 the samples whatever the initial dry density, the percentage of pre-swell and the
359 experimental method. This also enhances the conclusion that the final state of the
360 sample controls the swelling pressure. Further analysis showed that the swelling
361 pressure mainly depends on the final dry density of bentonite in the mixture. This
362 observation is in agreement with the conclusion of Lee et al. (1999) and Agus (2005)
363 who noted that the swelling pressure of bentonite/sand mixtures with different
364 bentonite contents is a function of the final bentonite dry density. This suggests that
365 the swelling mechanism of bentonite-based materials is the same as that of pure
366 bentonites.

367 At the same void ratio, the swelling pressure determined by different methods was
368 found slightly lower than the vertical stress needed to reach the same void ratio
369 following the swell-reload path (swell-consolidation method). This was in agreement
370 with the results by many other authors (Justo et al., 1984; Sridharan et al., 1986;
371 Basma et al., 1995; Abdullah et al., 1998, 1999; Agus, 2005; Villar, 1999; Villar et al.,
372 2008), and can be considered as a consequence of the coupling between the
373 microstructure and macrostructure (Gens and Alonso, 1992; Villar, 1999; Sánchez et
374 al., 2005). For the swell-consolidation oedometer test, wetting took place under a low
375 vertical load and the void ratio increased greatly due to the large microstructural
376 changes. In this case, intense breakage of particle aggregates occurs, leading to
377 relatively uniform distribution of the expandable component. A relatively high
378 vertical stress was needed to compensate this large macrostructure deformation. By

379 contrast, smaller microstructure and macrostructure interaction is expected in other
380 methods, with lower stress at full saturation. Furthermore, the relative larger
381 displacement in the swell-consolidation oedometer test would mobilise higher friction
382 and this friction can also contribute to the phenomenon observed.
383

384 **6 CONCLUSION**

385 The swelling pressure of bentonite/claystone mixture was determined by different
386 methods. The effects of the water chemistry, the hydration procedure, the
387 pre-existing technical voids and the experimental methods on the swelling pressure
388 were investigated. From the experimental results the following conclusion can be
389 drawn.

390 There was no obvious effect of water chemistry on the swelling pressure due to the
391 high density and the low salinity of synthetic water.

392 An exponential function was found between the swelling pressure and the suction
393 applied; no effect of hydration procedure on the final swelling pressure was observed.

394 The swell-consolidation method gives higher swelling pressure mainly because of
395 the coupling between the microstructure deformation and macrostructure
396 deformation. The effect of friction is also to be considered for this phenomenon.

397 The swelling pressure of bentonite-based materials mainly depends on the final dry
398 density of the bentonite in the mixture, suggesting that the swelling mechanism of
399 bentonite-based materials is the same as that of pure bentonites. A general relationship
400 between the swelling pressure and the final dry density of various bentonites was
401 proposed, with two parameters depending on the montmorillonite content and the type
402 of exchangeable cations.

403 From a practical point of view, the relationship elaborated between the swelling
404 pressure and the final bentonite dry density is helpful in designing the sealing/filling
405 buffers with bentonite-based materials: when the initial state of bentonite-based
406 materials and the technical voids are known, the final swelling pressure can be
407 predicted. Moreover, the crushed Cox claystone can be used to form the
408 bentonite/claystone mixture because it behaves as sand. However it should be noted
409 that this conclusion is based on the results from one year tests and further studies with
410 longer tests are needed to gain more confidence on this aspect.

411

412 **Acknowledgements**

413 This work was conducted within the framework of GM2 of the French National Agency for
414 Nuclear Waste Management (ANDRA). The conclusions and the viewpoints presented in the
415 paper are those of the authors and do not necessarily coincide with those of ANDRA. The support
416 from the PHC Cai Yuanpei project (24077QE) and that of the China Scholarship Council (CSC)
417 are also greatly acknowledged.

418

419 **7 REFERENCE**

420

421 Abdullah, I., Mhaidib, A., 1998. Prediction of swelling potential of an expansive shale.
422 Proceedings Of The Second International Conference On unsaturated soils. 27-30
423 August. Beijing, China: vol. 1.

424 Abdullah, I., Mhaidib, A.I., 1999. Swelling behaviour of expansive shales from the middle
425 region of Saudi Arabia. *Geotechnical and Geological Engineering*. 16(4):291–307.

426 Agus, S., 2005. An Experimental study on hydro-mechanical characteristics of compacted
427 bentonite-sand mixtures. PhD thesis. Weimar.

428 Agus, S., Schanz, T., 2005. Swelling pressures and wetting-drying curves of a highly
429 compacted bentonite-sand mixture. *Unsaturated Soils: Experimental Studies*, pages
430 241–256.

431 Andra, 2005. Référentiel des matériaux d'un stockage de déchets à haute activité et à vie
432 longue – Tome 4: Les matériaux à base d'argilites excavées et remaniées. Rapport
433 Andra N° CRPASC040015B.

434 Arifin, Y.F., 2008. Thermo-hydro-mechanical behavior of compacted bentonite sand
435 mixtures: An Experimental Study. PhD thesis. Weimar.

436 Attom, M.; Abu-Zreig, M. & Obaidat, M. 2001. Changes in clay swelling and shear strength
437 properties with different sample preparation techniques. *ASTM geotechnical testing*
438 *journal*, ASTM, 24, 157-163.

439 Barnichon, J.D., and Deleruyelle, F., 2009. Sealing Experiments at the Tournemire URL.
440 Towards convergence of technical nuclear safety practices in Europe, EUROSAFE.

441 Basma, A.A., Al-Homoud, A.S., Husein, A., 1995. Laboratory assessment of swelling
442 pressure of expansive soils. *Applied Clay Science*, 9(5):355–368.

443 Borgesson, L. 1985. Water flow and swelling pressure in non-saturated bentonite-based clay
444 barriers. *Engineering Geology*, 21(3-4):229–237.

445 Borgesson, L., Chijimatsu, M., Fujita, T., Nguyen, T.S., Rutqvist, J., Jing, L., 2001.
446 Thermo-hydro-mechanical characterisation of a bentonite-based buffer material by
447 laboratory tests and numerical back analyses. *International Journal of Rock Mechanics*
448 *and Mining Sciences*, 38(1):95–104.

449 Castellanos, E., Villar, M.V., Romero, E., Lloret, A., Gens, A., 2008. Chemical impact on
450 the hydro-mechanical behaviour of high-density febex bentonite. *Physics and*
451 *Chemistry of the Earth, Parts A/B/C*, 33(Supplement 1):S516 – S526.

452 Cui, Y. J., Loiseau, C., Delage, P., 2002. Microstructure changes of a confined swelling soil
453 due to suction controlled hydration *Unsaturated soils: proceedings of the Third*
454 *International Conference on Unsaturated Soils, UNSAT 2002*, 10-13 March 2002,
455 Recife, Brazil, 593.

456 Cui, Y.J., Tang, A.M., Loiseau, C., Delage, P., 2008. Determining the unsaturated hydraulic
457 conductivity of a compacted sand-bentonite mixture under constant-volume and
458 free-swell conditions. *Physics and Chemistry of the Earth, Parts A/B/C*, 33(Supplement
459 1): 462 – S471.

460 Day, R.W. 1994. Swell-shrink behaviour of expansive compacted clay. *J. Geotechnical*

461 Engineering, ASCE 120, No. 3, 618–623.

462 Delage, P., Howat, M. D. & Cui, Y. J., 1998. The relationship between suction and swelling
463 properties in a heavily compacted unsaturated clay. *Engineering Geology* 50, 31-48.

464 Delage, P., Marcial, D., Cui, Y.J., and Ruiz, X., 2006. Ageing effects in a compacted
465 bentonite: a microstructure approach. *Geotechnique*, 56(5):291–304.

466 Delage, P. 2006. Some microstructure effects on the behaviour of compacted swelling clays
467 used for engineered barriers. *Chinese Journal of Rock Mechanics and Engineering*,
468 Science Press(Beijing), 16 Donghuangchenggen North St, Beijing, 100717, China., 25,
469 721-732.

470 Delage, P., Cui, Y.J., Tang, A.M., 2010. Clays in radioactive waste disposal, *Journal of Rock*
471 *Mechanics and Geotechnical Engineering*, Vol (2):111–123.

472 Dixon, D.A., Gray, M.N., Graham, J., 1996. Swelling and hydraulic properties of bentonites
473 from Japan, Canada and USA. In *Proceedings of the second International Congress on*
474 *Environmental Geotechnics*, Osaka, Japan, pages 5–8.

475 Dixon, D.A., Graham, J., and Gray, M.N., 1999. Hydraulic conductivity of clays in confined
476 tests under low hydraulic gradients. *Canadian Geotechnical Journal*, 36(5):815–825.

477 Gens, A., Alonso, E.E. 1992. A framework for the behaviour of unsaturated expansive clays.
478 *Canadian Geotechnical Journal*, 29(6):1013–1032.

479 Hoteit N, Ozanam-O, Su, K. 2000. Geological radioactive waste disposal project in france-
480 conceptual model of a deep geological formation and underground research laboratory
481 in Meuse Haute-Marne site. In *The 4th North American Rock Mechanics Symposium*,
482 Seattle, July 31-August 3.

483 Imbert, C., and Villar, M.V., 2006. Hydro-mechanical response of a bentonite pellets-powder
484 mixture upon infiltration. *Applied Clay Science*, 32(3-4):197–209.

485 Justo, J.L., Delgado, A., Ruiz, J., 1984. The influence of stress-path in the collapse-swelling
486 of soils at the laboratory. In *Fifth International Conference on Expansive Soils 1984*.
487 Australia. Page 67.

488 Karnland, O., Muurinen, A., Karlsson, F., 2005. Bentonite swelling pressure in NaCl
489 solutions-Experimentally determined data and model calculations. *Advances in*
490 *Understanding Engineering Clay Barriers*. Page 241.

491 Karnland, O., Nilsson, U., Weber, H., and Wersin, P., 2008. Sealing ability of Wyoming
492 bentonite pellets foreseen as buffer material-Laboratory results. *Physics and Chemistry*
493 *of the Earth, Parts A/B/C*, 33:S472–S475.

494 Kenney, T.C., Veen, W.A.V., MA Swallow, and Sungaila., M.A., 1992. Hydraulic
495 conductivity of compacted bentonite-sand mixtures. *Canadian Geotechnical Journal*,
496 29(3):364–374.

497 Komine., H., Ogata, N. 1994. Experimental study on swelling characteristics of compacted
498 bentonite. *Canadian geotechnical journal*, 31(4):478–490.

499 Komine., H., Ogata, N. 1998. Thermal influence on compacted bentonite for nuclear waste
500 disposal. In *Proceedings of the 3rd International Congress on Environmental*
501 *Geotechnics*, volume 1, pages 34–39.

502 Komine., H., Ogata, N. 2003. New equations for swelling characteristics of bentonite-based
503 buffer materials. *Canadian Geotechnical Journal*, 40(2):460–475.

504 Komine., H., Ogata, N. 2004a. Predicting swelling characteristics of bentonites. *Journal of*

505 Geotechnical and Geoenvironmental engineering, 130:818.

506 Komine, H., 2004b. Simplified evaluation for swelling characteristics of bentonites,
507 Engineering geology, 71(3-4): 265-279.

508 Komine, H. Yasuhara, K. and Murakami, S. 2009. Swelling characteristics of bentonites in
509 artificial seawater. Canadian Geotechnical Journal, 46(2):177-189.

510 Kröhn, K.P. 2003. Results and interpretation of bentonite resaturation experiments with
511 liquid water and water vapour. In: Schanz, T. (Ed.), Proceedings of the International
512 Conference from Experimental Evidence towards Numerical Modeling of Unsaturated
513 Soils, Weimar, Germany, vol. 1. 598 Springer, Berlin, pp. 257–272.

514 Lebon, P. and Ghoreychi, M. 2000. French underground research laboratory of Meuse,
515 Haute-Marne THM aspects of argillite formation. In Eurock 2000 Symposium, March,
516 pages 27–31.

517 Lee, J.O., Cho, W.J. and Chun, K.S., 1999. Swelling Pressures of a Potential Buffer Material
518 for High-Level Waste Repository. Journal of the Korean Nuclear Society, 31: 139-150.

519 Lemaire, T., Moyne, C., and Stemmelen, D., 2004. Imbibition test in a clay powder (MX-80
520 bentonite). Applied Clay Science, 26(1-4):235–248.

521 Li, X.L., Bastiaens, W., Van Marcke, P., et al., 2009. Design and Development of the Large
522 Scale In-situ PRACLAY Heater Test and Horizontal HLW Disposal Gallery Seal Test in
523 Belgian URL Hades, International Symposium on Unsaturated Soil Mechanics and
524 Deep Geological Nuclear Waste Disposal , Shanghai, China: 24—28.

525 Loiseau, C., Cui, Y.J. and Delage, P., 2002. The gradient effect on the water flow through a
526 compacted swelling soil, In: Proc. 3rd Int Conf Unsaturated Soils, UNSAT 2002, Recife,
527 Brazil, Balkema 1:395–400.

528 Nagaraj, H.; MOHAMMED Munnas, M.; Sridharan, A., 2009. Critical Evaluation of
529 Determining Swelling Pressure by Swell-Load Method and Constant Volume Method,
530 ASTM geotechnical testing journal, ASTM, 32, 305-314.

531 Nalezny, C. L. & Li, M. C., 1967. Effects of soil moisture and thixotropic hardening on the
532 swell behaviour of compacted expansive soils. Highway Res. Rec. Washington, DC:
533 Highway Research Board. No. 209.

534 Pusch, R., 1979. Highly compacted sodium bentonite for isolating rock-deposited
535 radioactive waste products. Nucl. Technol, United States. 45(2):153-157.

536 Pusch, R. 1980. Swelling pressure of highly compacted bentonite. SKBF/KBS technical
537 report: No.80-13.

538 Pusch, R., 1982. Mineral-water interactions and their influence on the physical behavior of
539 highly compacted Na bentonite. Canadian Geotechnical Journal, 19(3):381–387.

540 Pusch, R., 2001a. Experimental study of the effect of high porewater salinity on the physical
541 properties of a natural smectitic clay, SKBF/KBS technical report. No.TR01-07.

542 Pusch, R. 2001b. The microstructure of MX-80 clay with respect to its bulk physical
543 properties under different environmental conditions, SKBF/KBS technical report.
544 No.TR01-08.

545 Romero, E., Gens, A., and Lloret, A., 2001. Temperature effects on the hydraulic behaviour
546 of an unsaturated clay. Geotechnical and Geological Engineering, 19(3):311–332.

547 Saiyouri, N., Tessier, D., and Hicher, P.Y., 2004. Experimental study of swelling in

548 unsaturated compacted clays. *Clay Minerals*, 39(4):469.

549 Sanchez, M., Gens, A., Do Nascimento Guimarães, L., Olivella, S., 2005. A double structure
550 generalized plasticity model for expansive materials. *International Journal for*
551 *Numerical and Analytical Methods in Geomechanics*, 29(8):751–787.

552 Siddiqua, S.; Blatz, J. & Siemens, G. 2011. Evaluation of the impact of pore fluid chemistry
553 on the hydromechanical behaviour of clay-based sealing materials. *Canadian*
554 *Geotechnical Journal*, NRC Research Press, 48, 199-213.

555 Siemens, G., and Blatz, J.A., 2009. Evaluation of the influence of boundary confinement on
556 the behaviour of unsaturated swelling clay soils. *Canadian Geotechnical Journal*,
557 46(3):339–356.

558 Sridharan, A., Rao, S., Sivapullaiah, P.V., 1986. Swelling pressure of clays. *ASTM*
559 *geotechnical testing journal*, 9(1):24–33.

560 Sugita, Y., Chijimatsu, M., and Suzuki, H., 2005. Fundamental properties of bentonite pellet
561 for Prototype Repository Project. *Advances in Understanding Engineering Clay*
562 *Barriers*, page 293.

563 Suzuki, S.; Prayongphan, S.; Ichikawa, Y. & Chae, B. 2005. In situ observations of the
564 swelling of bentonite aggregates in NaCl solution, *Applied Clay Science*, Elsevier, 29:
565 89-98.

566 Subba Rao, K. S. & Tripathy, S. 2003. Effect of aging on swelling and swell-shrink behaviour
567 of a compacted expansive soil. *ASTM Geotech. Test. J.* 26, No. 1, 36–46.

568 Tang, A.M., Cui, Y.J., 2005. Controlling suction by the vapour equilibrium technique at
569 different temperatures and its application in determining the water retention properties
570 of MX80 clay. *Canadian Geotechnical Journal*, 42 (1): 287-296.

571 Tang, A.M., Cui, Y.J., Barnel, N., 2007. A new isotropic cell for studying the
572 thermo-mechanical behavior of unsaturated expansive soil. *Geotechnical Testing*
573 *Journal*, 30 (5): 341 – 348.

574 Tang, A.M., Cui, Y.J., Barnel, N., 2008a. Thermo-mechanical behaviour of a compacted
575 swelling clay. *Géotechnique*, 58 (1): 45-54.

576 Tang, A.M., Cui, Y.J., Le, T.T., 2008b. A study on the thermal conductivity of compacted
577 bentonites. *Applied Clay Science*, 41 (3-4): 181 – 189.

578 Tang, A.M., Cui, Y.J., 2009. Modelling the thermo-mechanical behaviour of compacted
579 expansive clays. *Géotechnique*, 59 (3): 185-195.

580 Tang, C.S., Tang, A.M., Cui, Y.J., Delage, P., Barnichon, J.D., Shi, B., 2011a. A study of the
581 hydro-mechanical behaviour of compacted crushed argillite. *Engineering Geology*. 118
582 (3-4):93-103.

583 Tang, C.S., Tang, A.M., Cui, Y.J., Delage, P., Schroeder, C., De Laure, E., 2011b.
584 Investigating the Swelling Pressure of Compacted Crushed-Callovo-Oxfordian Argillite.
585 *Physics and Chemistry of the Earth*. (accepted)

586 Villar, M.V., Lloret, A., 2004. Influence of temperature on the hydro-mechanical behaviour
587 of a compacted bentonite. *Applied Clay Science*, 26(1-4):337 – 350.

588 Villar, M.V., 1999. Investigation of the behaviour of bentonite by means of
589 suction-controlled oedometer tests. *Engineering Geology*, 54(1-2):67–73.

590 Villar, M.V., 2002. Thermo-hydro-mechanical characterisation of a bentonite from Cabo de
591 Gata. A study applied to the use of bentonite as sealing material in high level

- 592 radioactive waste repositories. Publicación Técnica ENRESA 01/2002, Madrid, 258 pp.
- 593 Villar, M.V., Lloret, A., 2008. Influence of dry density and water content on the swelling of a
594 compacted bentonite. *Applied Clay Science*, 39(1-2):38–49.
- 595 Yang, J., Samper, C., and Montenegro, L., 2008. A coupled non-isothermal reactive transport
596 model for long-term geochemical evolution of a HLW repository in clay.
597 *Environmental Geology*, 53(8):1627–1638.
- 598 Yong, R.N., Boonsinsuk, P., and Wong, G., 1986. Formulation of backfill material for a
599 nuclear fuel waste disposal vault. *Canadian Geotechnical Journal*, 23(2):216–228.
- 600 Zhang, C., and Rothfuchs, T., 2004. Experimental study of the hydro-mechanical behaviour
601 of the Callovo-Oxfordian argillite. *Applied Clay Science*, 26(1-4):325–336.

602 **List of Tables**

603 Table 1 Characteristics of MX80 bentonite (Tang et al., 2008)

604 Table 2 Chemical components of the synthetic water

605 Table 3 Test programme

606 Table 4 Montmorillonite content and external cations type of several bentonites

607 **List of Figures**

608 Figure 1. Grain size distribution of MX80 bentonite and crushed COx claystone

609 Figure 2. Stress path of various experimental methods used to determine the swelling pressure

610 Figure 3. Constant-volume cell

611 Figure 4. Schematic view of constant volume cell with suction control system

612 Figure 5. Evolution of swelling pressure for test CV01 and CV02 during the first 100 h.

613 Figure 6. Evolution of swelling pressure for test CV03 during decreasing of suction.

614 Figure 7. Swelling pressure versus suction of test CV03

615 Figure 8. Evolution of swelling pressure for tests CV01, CV02, and CV03 for 1 year

616 Figure 9. Evolution of swelling pressure with various pre-swells

617 Figure 10. Swelling strain versus vertical stress applied for test SCO1

618 Figure 11. Pre-swell versus swelling pressure

619 Figure 12. Swelling pressure or vertical pressure versus void ratio of mixture

620 Figure 13. Swelling pressure versus final dry density of bentonite/claystone mixture

621 Figure 14. Results of various mixtures using MX80 bentonite - swelling pressure versus final dry
622 density of bentonite

623 Figure 15. Swelling pressure versus final dry density of bentonite

624

Table 1 Characteristics of MX80 bentonite (Tang et al., 2008b)

Montmorillonite (%)	92
Quartz (%)	3
w_l (%)	520
w_p (%)	42
I_p	478
ρ_s (Mg/m ³)	2.76

Table 2 Chemical components of the synthetic water

Components	NaHCO ₃	Na ₂ SO ₄	NaCl	KCl	CaCl ₂ .2H ₂ O	MgCl ₂ .6H ₂ O	SrCl ₂ .6H ₂ O
Mass (g) per 1L solution	0.28	2.216	0.615	0.075	1.082	1.356	0.053

Table 3 Test programme

Test No.	Injected water	Method	Initial dry density (Mg/m ³)	Duration
CV01	Distilled	Constant-volume	1.70	1 year
CV02	Synthetic	Constant-volume	1.70	1 year
CV03	Vapour and distilled	Constant-volume	1.70	1 year
PS01	Synthetic	Pre-swell $\epsilon = 10\%$	1.90	100 h
PS02	Synthetic	Pre-swell $\epsilon = 20\%$	1.90	100 h
PS03	Synthetic	Pre-swell $\epsilon = 25\%$	1.90	100 h
PS04	Synthetic	Pre-swell $\epsilon = \text{max}$	1.90	80 h
ZSO1	Synthetic	Zero-swell	1.70	80 h
SCO1	Synthetic	Swell-consolidation	1.90	4 months

Table 4 Montmorillonite content and external cations type of several bentonites

Bentonite	α	β	Montmorillonite Content (%)	Type
MX 80	1.78×10^{-4}	6.75	75-90	Na
FEBEX	9.80×10^{-5}	6.85	92	Ca
FoCa	7.83×10^{-7}	9.24	50 Beidellite 50 Kaollite	Ca
Kunigel V1	3.67×10^{-3}	3.32	48	Na

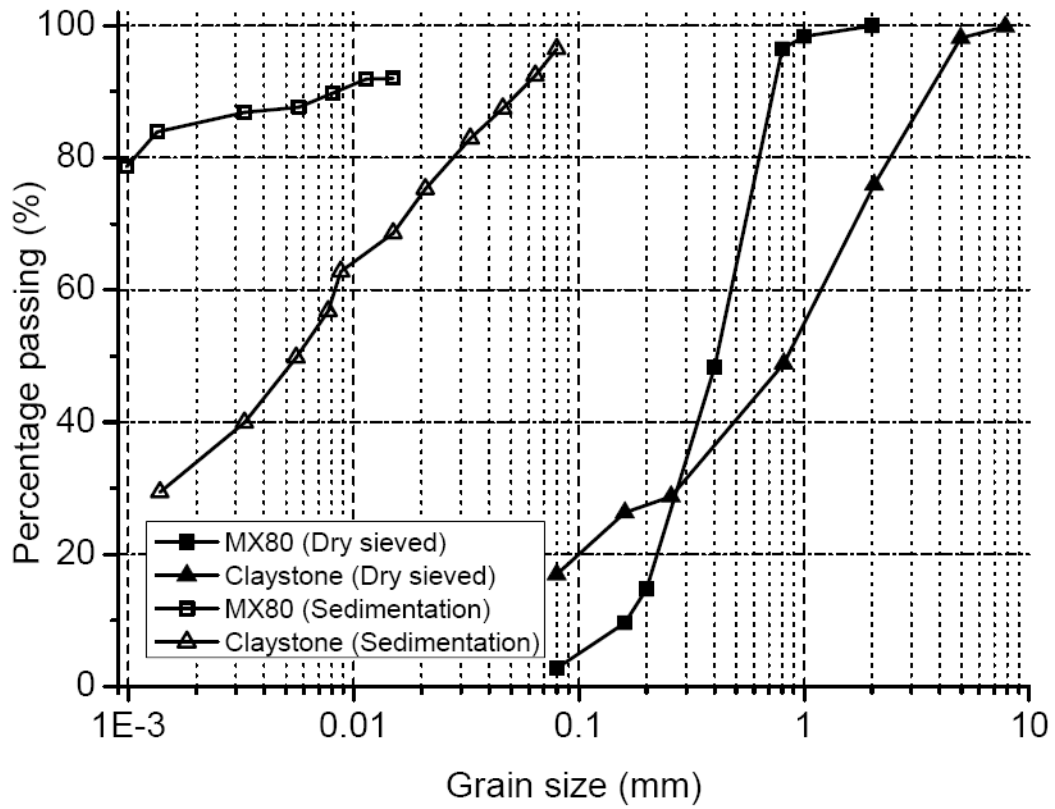

Figure 1. Grain size distribution of MX80 bentonite and crushed COx claystone

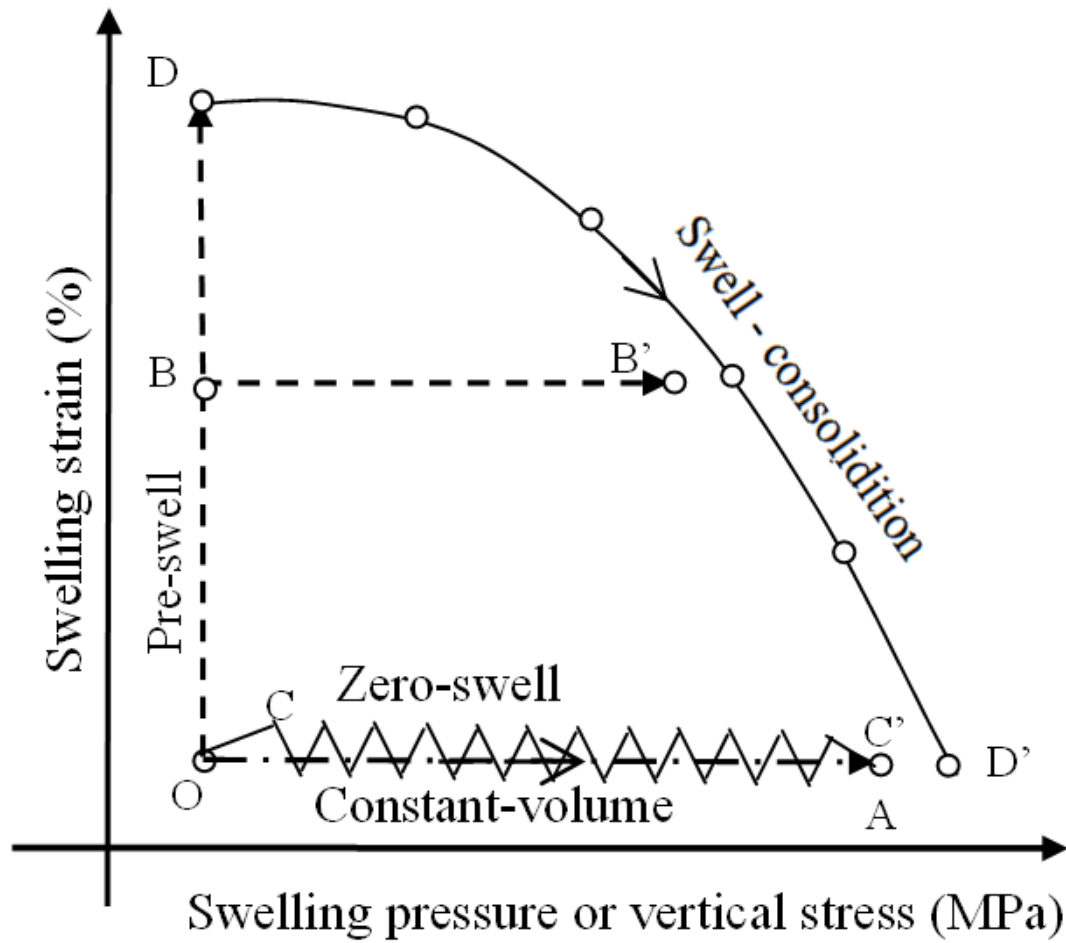

Figure 2. Stress path of various experimental methods used to determine the swelling pressure

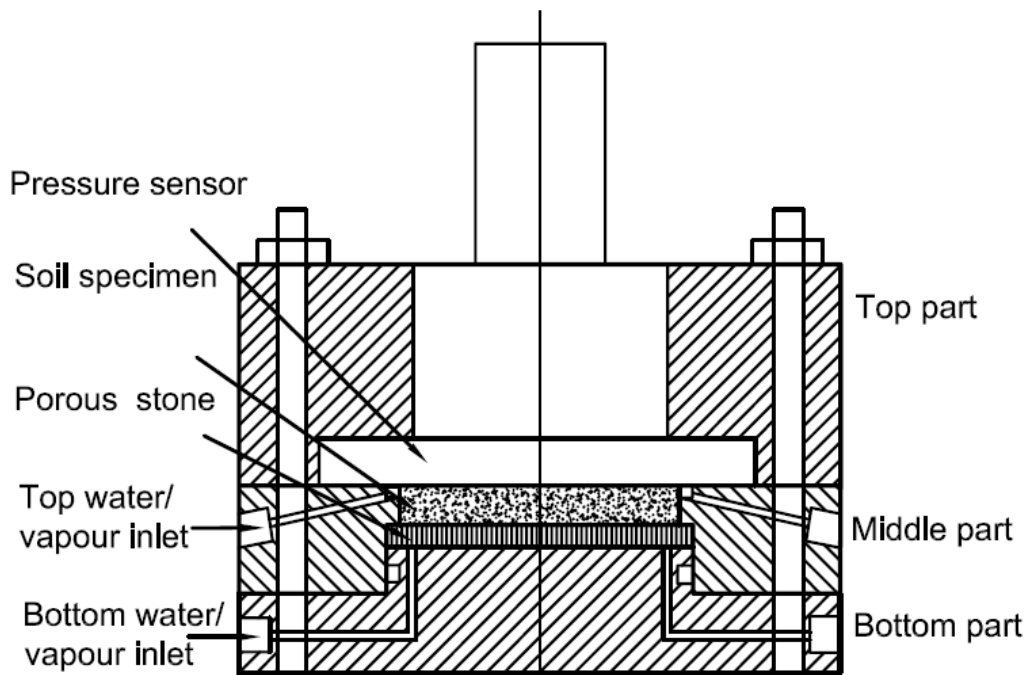

Figure 3. Constant-volume cell

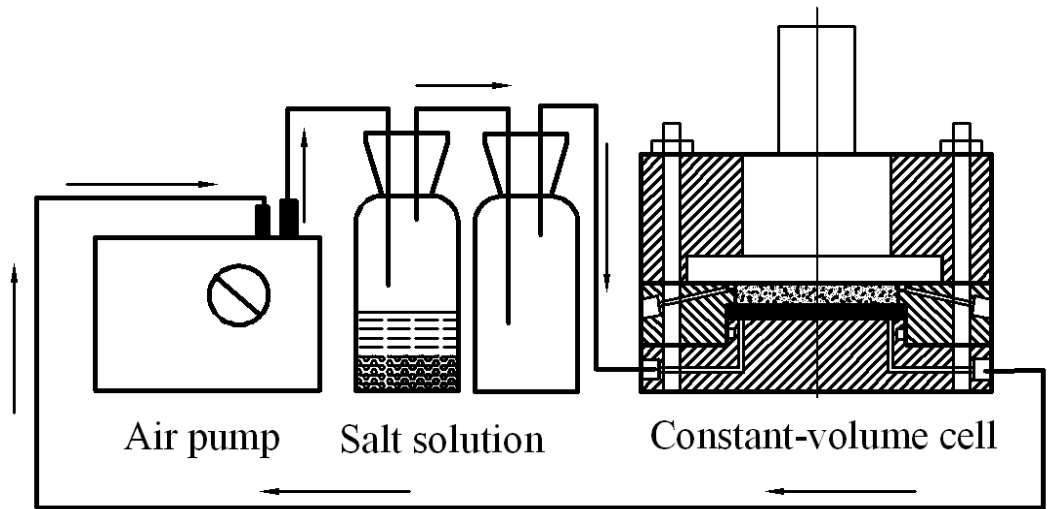

Figure 4. Schematic view of constant volume cell with suction control system

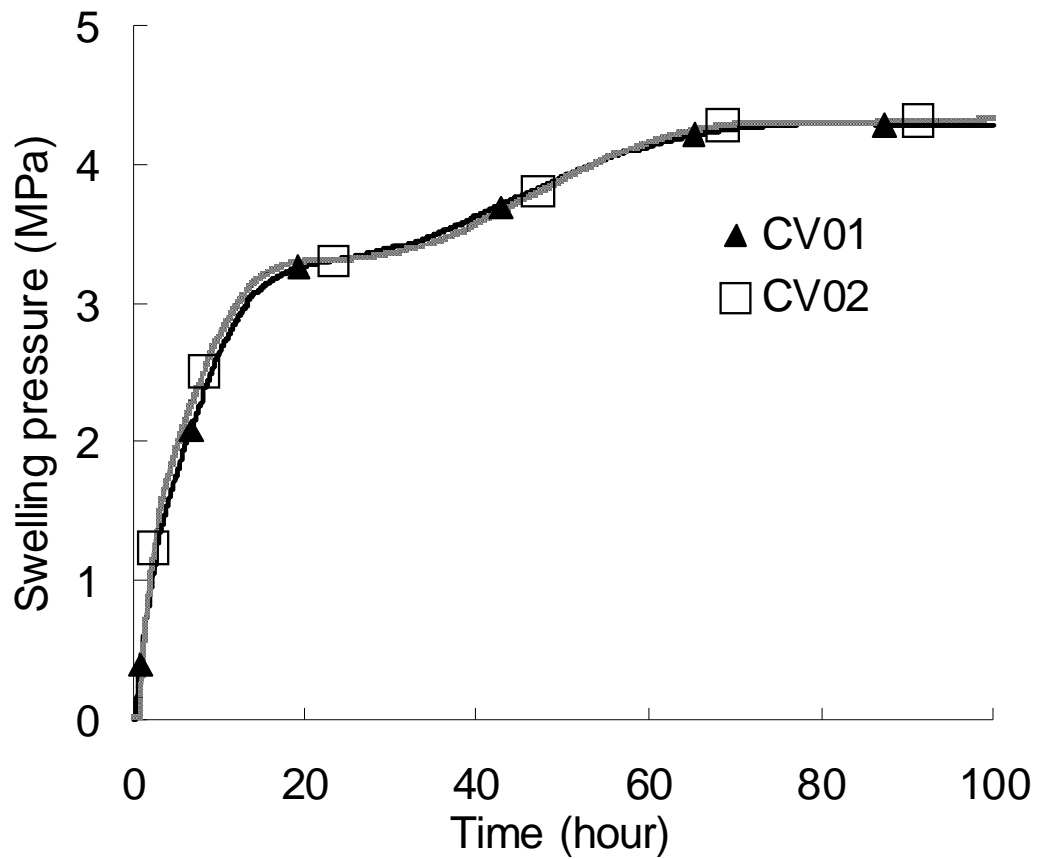

Figure 5. Evolution of swelling pressure for test CV01 and CV02 during the first 100 h.

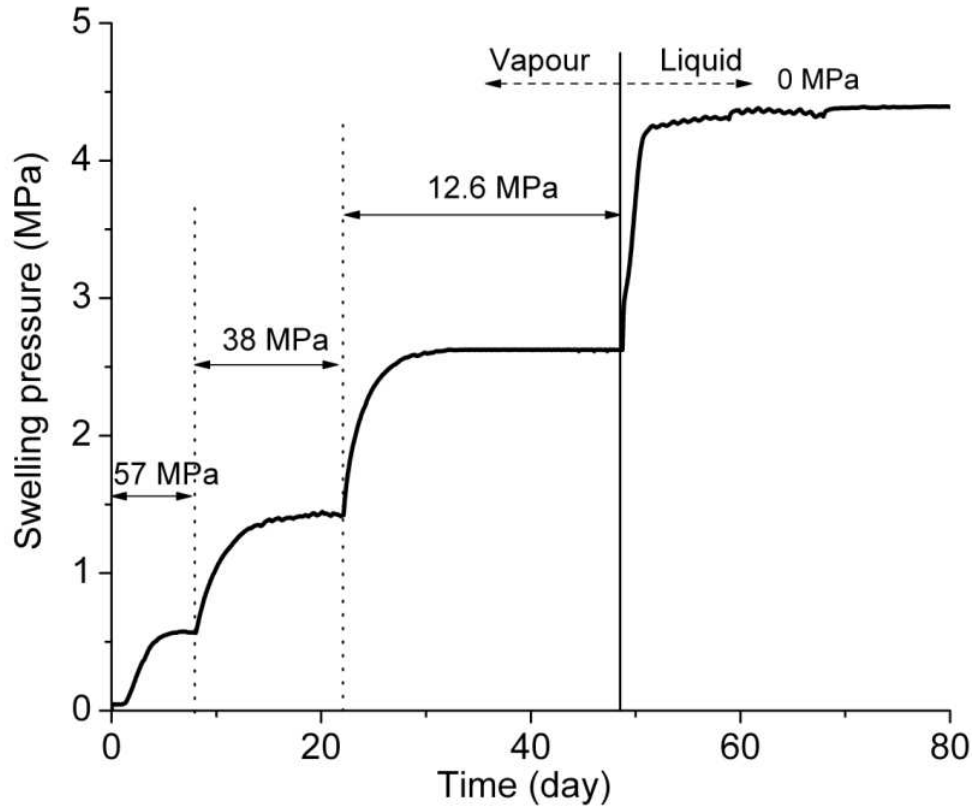

Figure 6. Evolution of swelling pressure for test CV03 during decreasing of suction.

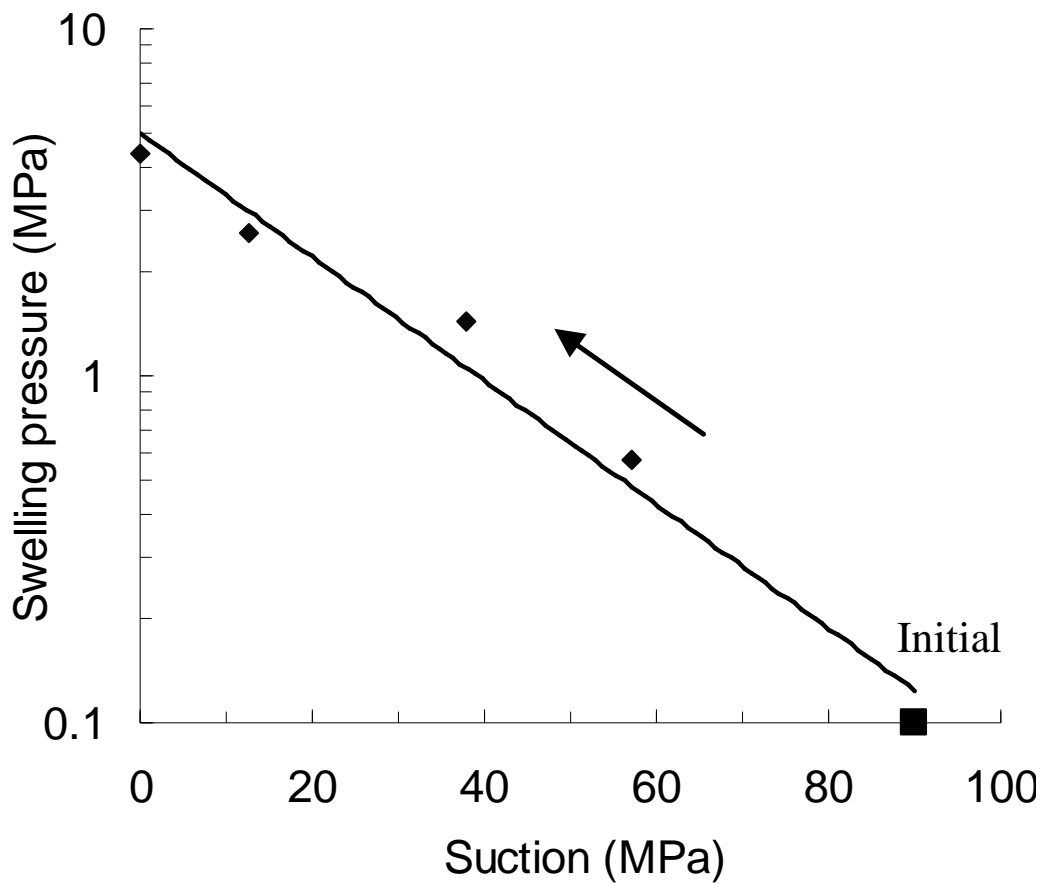

Figure 7. Swelling pressure versus suction of test CV03

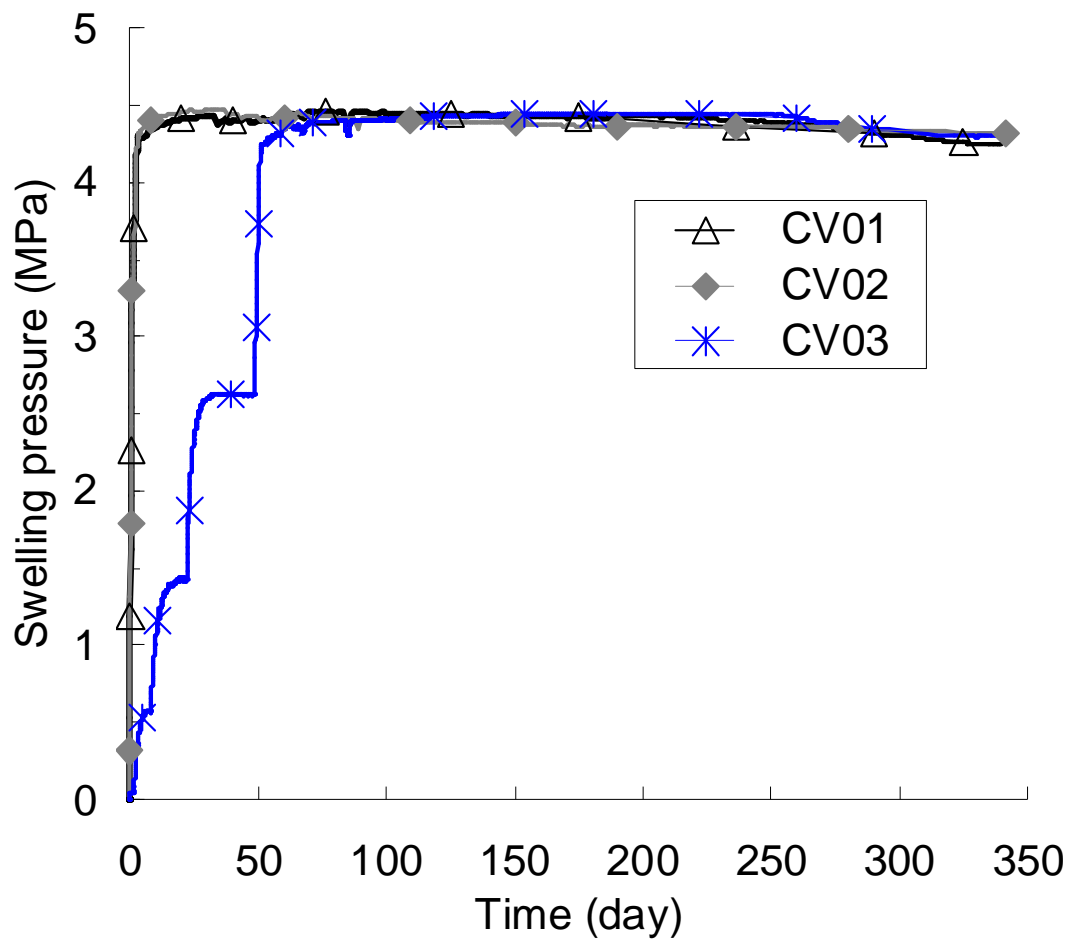

Figure 8. Evolution of swelling pressure for tests CV01, CV02, and CV03 for 1 year

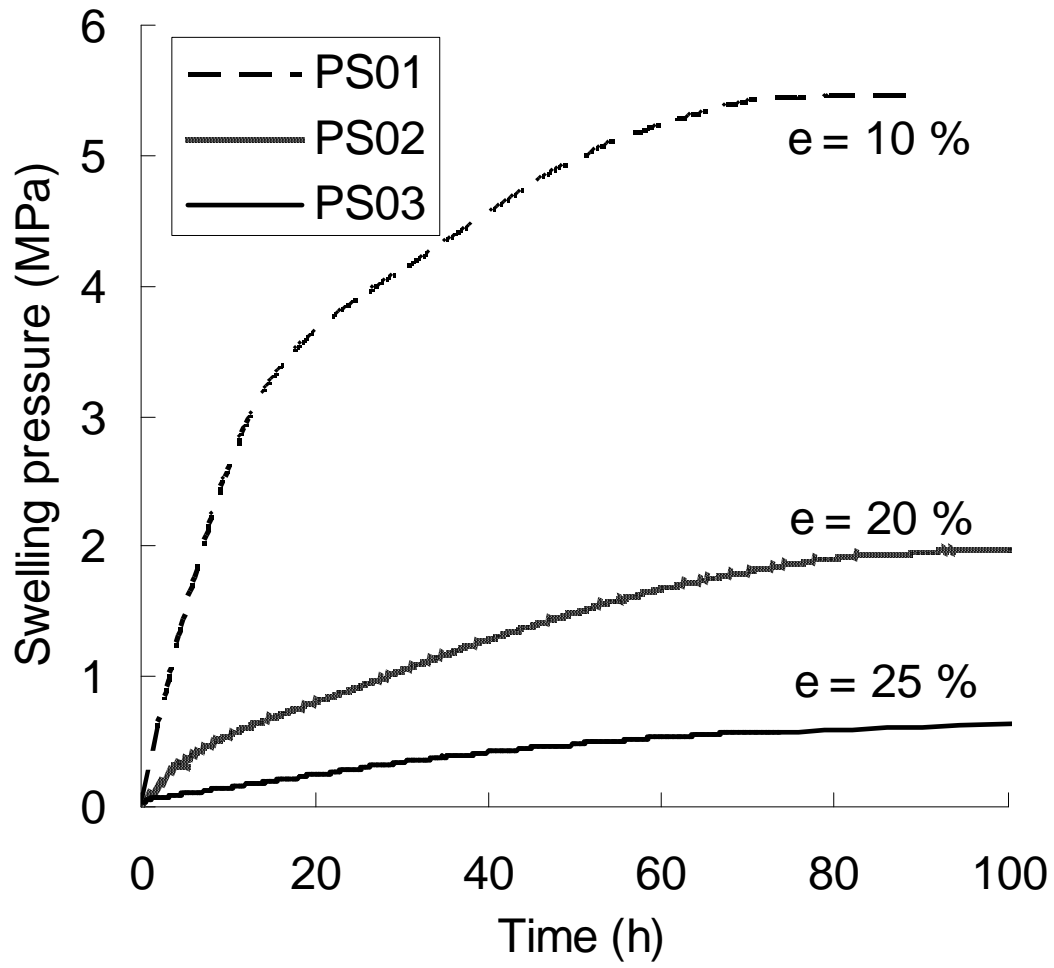

Figure 9. Evolution of swelling pressure with various pre-swells

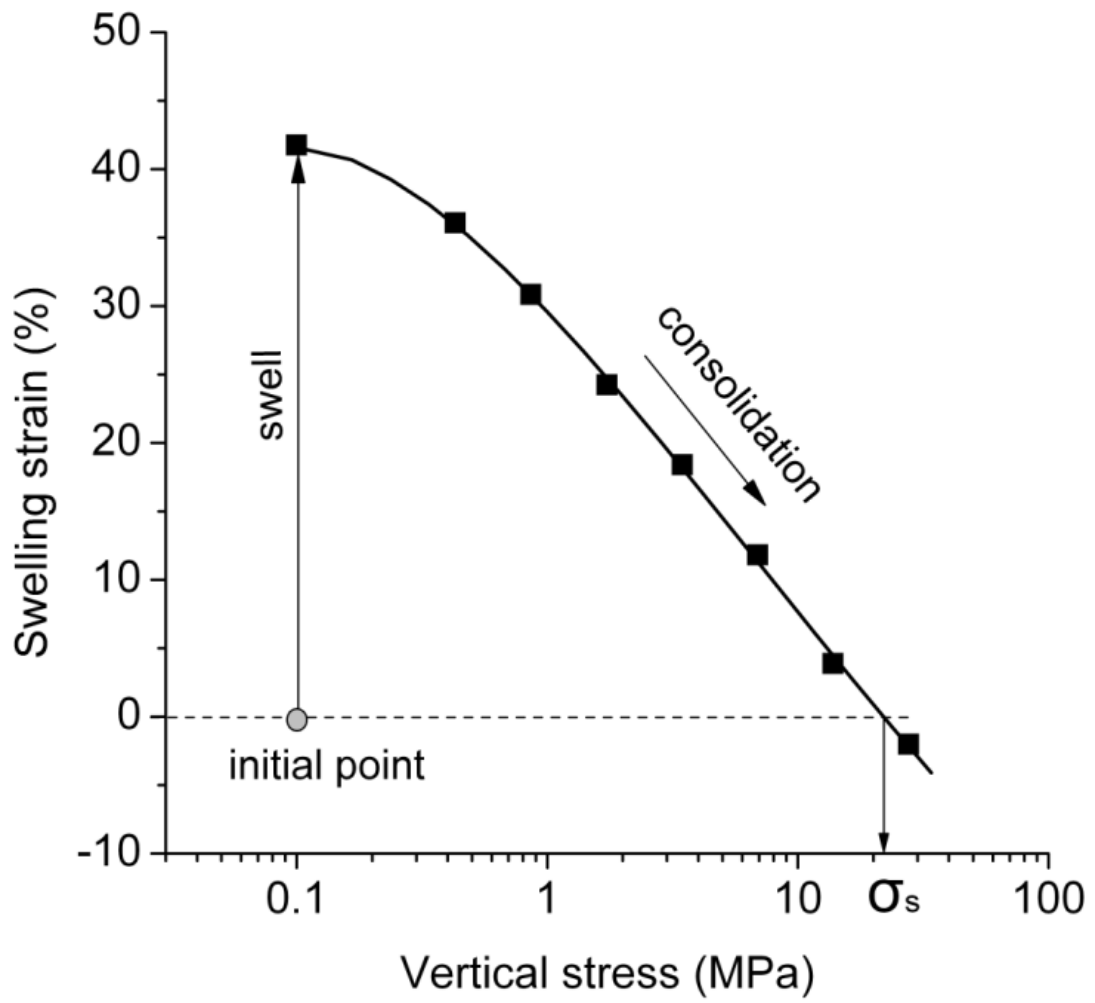

Figure 10. Swelling strain versus vertical stress applied for test SCO1

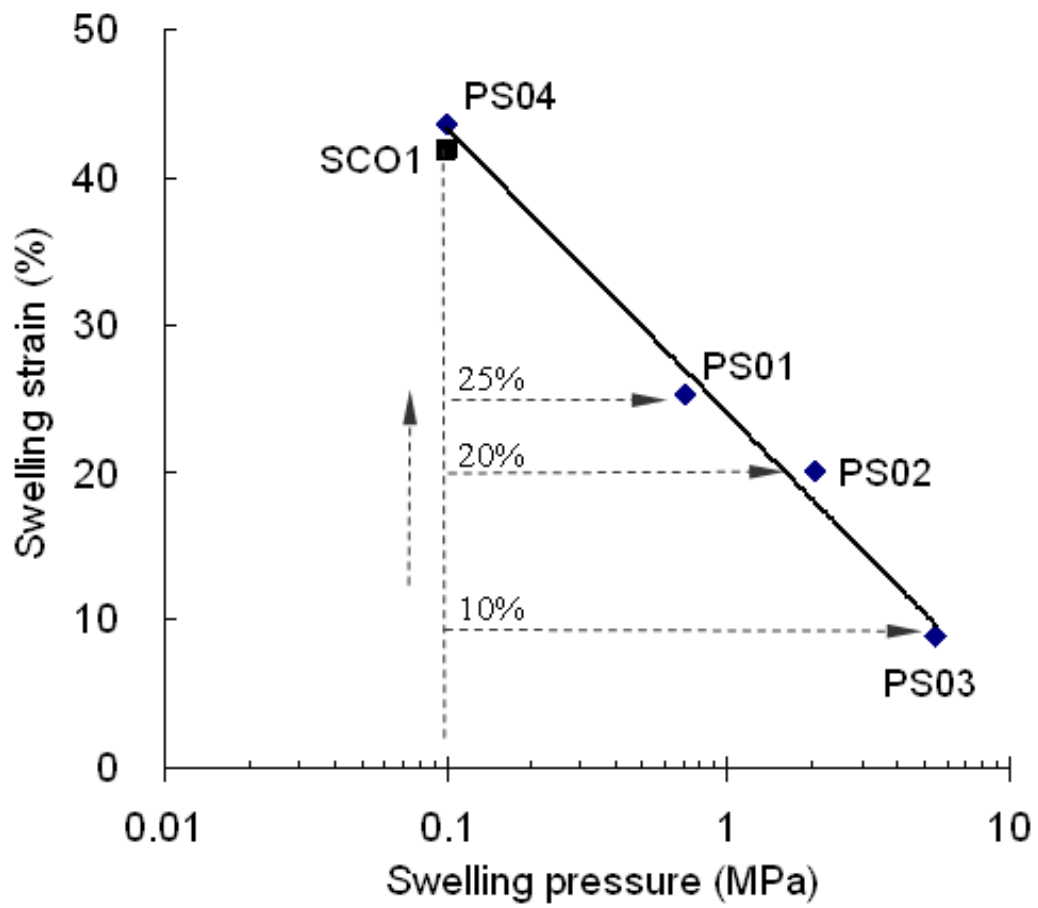

Figure 11. Pre-swell versus swelling pressure

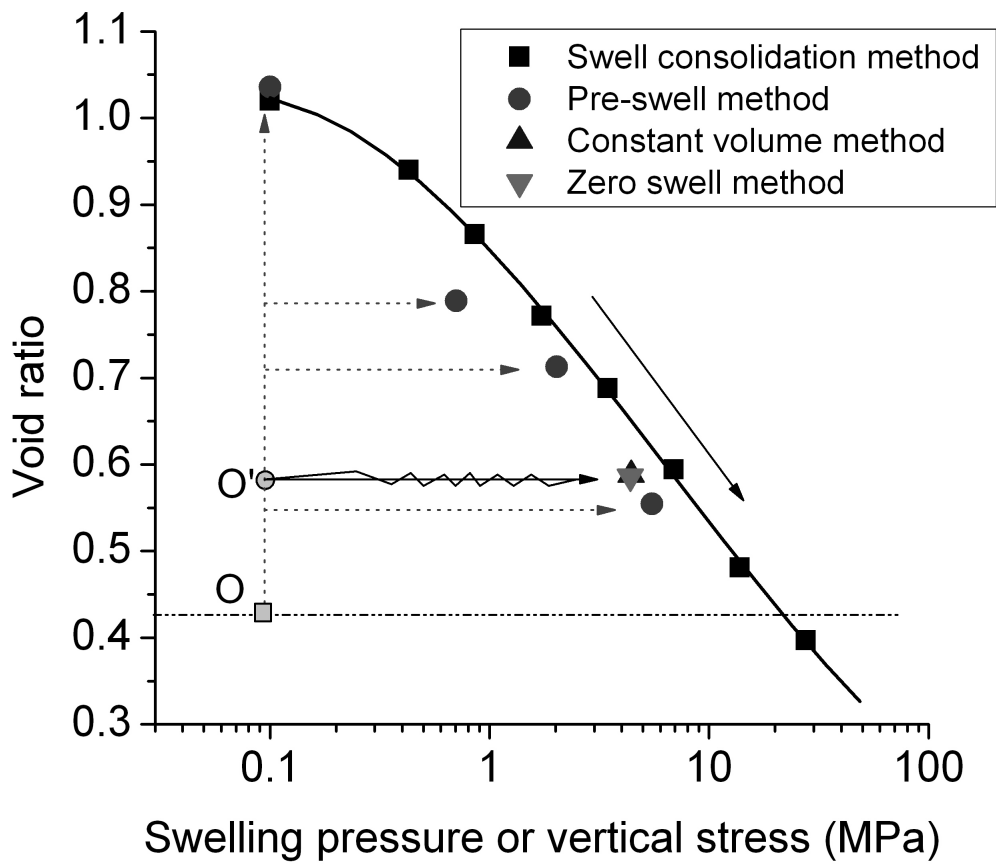

Figure 12. Swelling pressure or vertical pressure versus void ratio of mixture

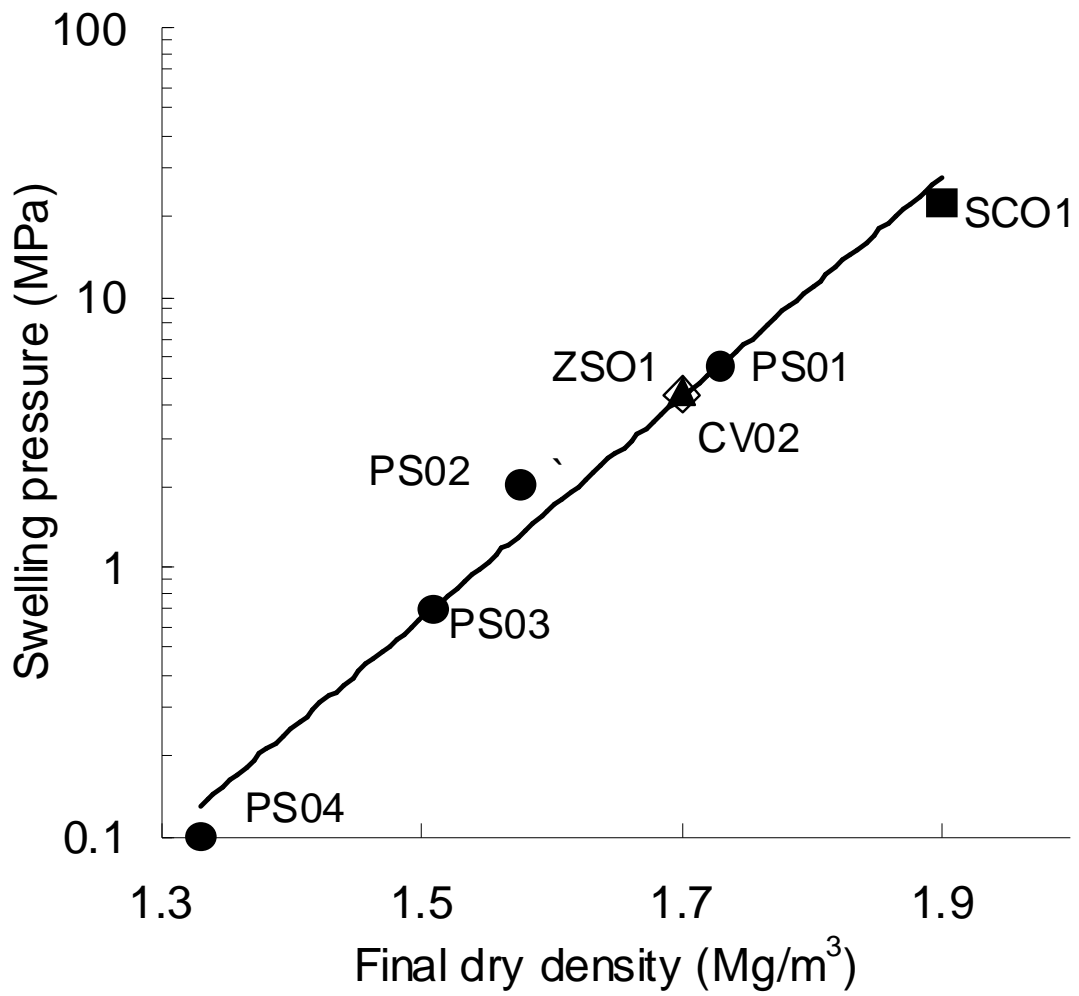
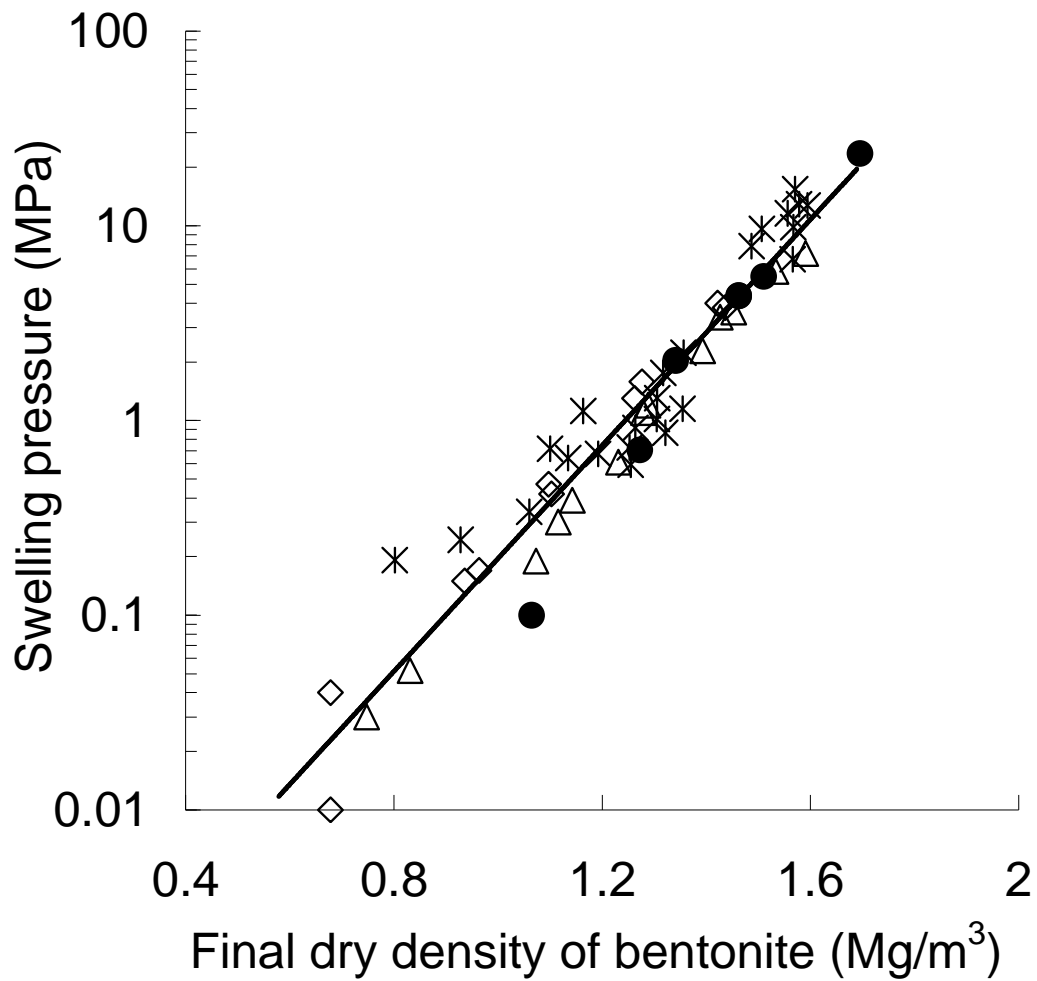

Figure 13. Swelling pressure versus final dry density of bentonite/claystone mixture



- Bentonite/claystone 70/30 (Present work)
- ◇ Bentonite/sand 70/30 (Karland et al. 2008)
- △ Pure bentonite (Karland et al. 2008)
- * Pure bentonite (Dixon et al. 1996)

Figure 14. Results of various mixtures using MX80 bentonite - swelling pressure versus final dry density of bentonite

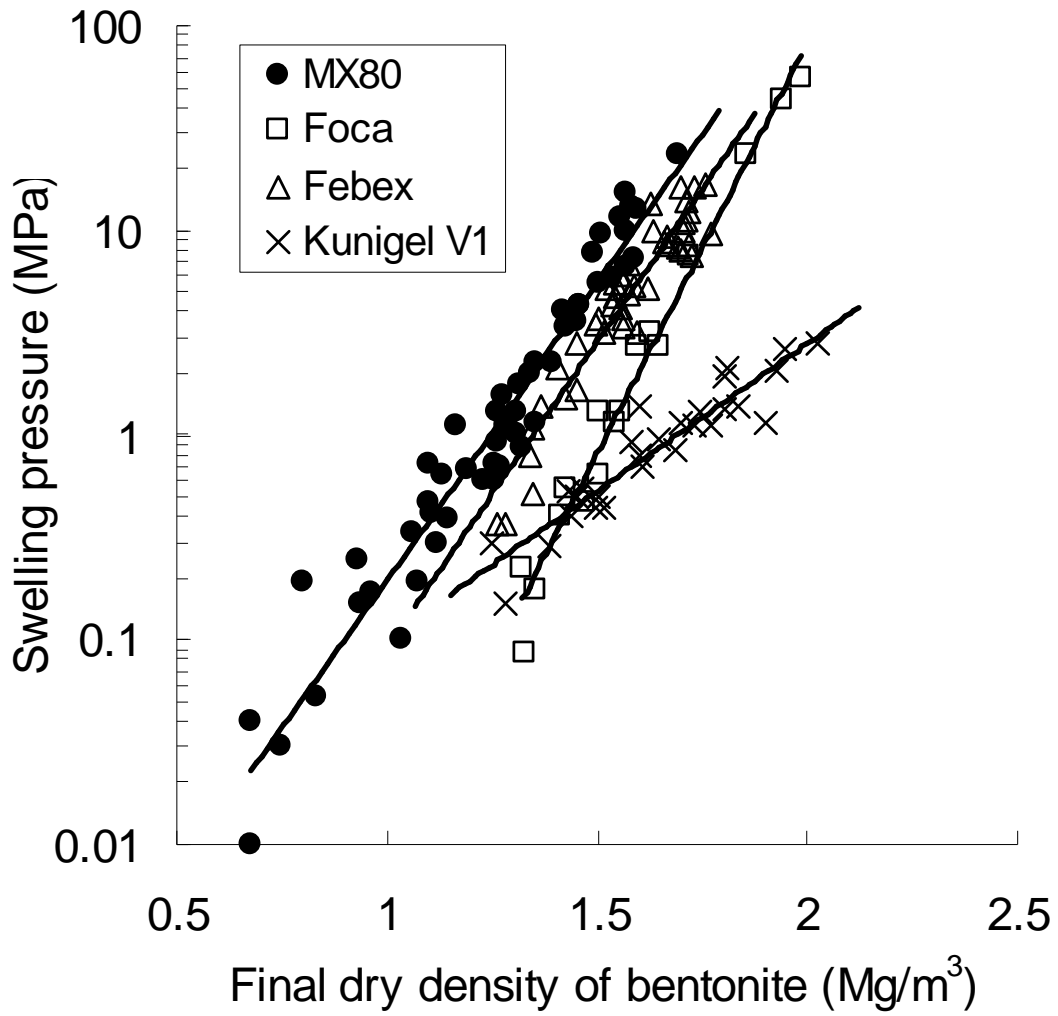

Figure 15. Swelling pressure versus final dry density of bentonite